

**M&T**  
manufacture 1997

**Představujeme Vám vyjímečný povrch Cr-K**

Originální, ručně broušený povrch, vzhledově i hmatově navozující atmosféru drásaného dřeva.



**Cr-K** černý chrom broušený 3D

*dodáváme na prestižní modelové řadě  
Minimal, Minimal 2.0 a madlech YES!*

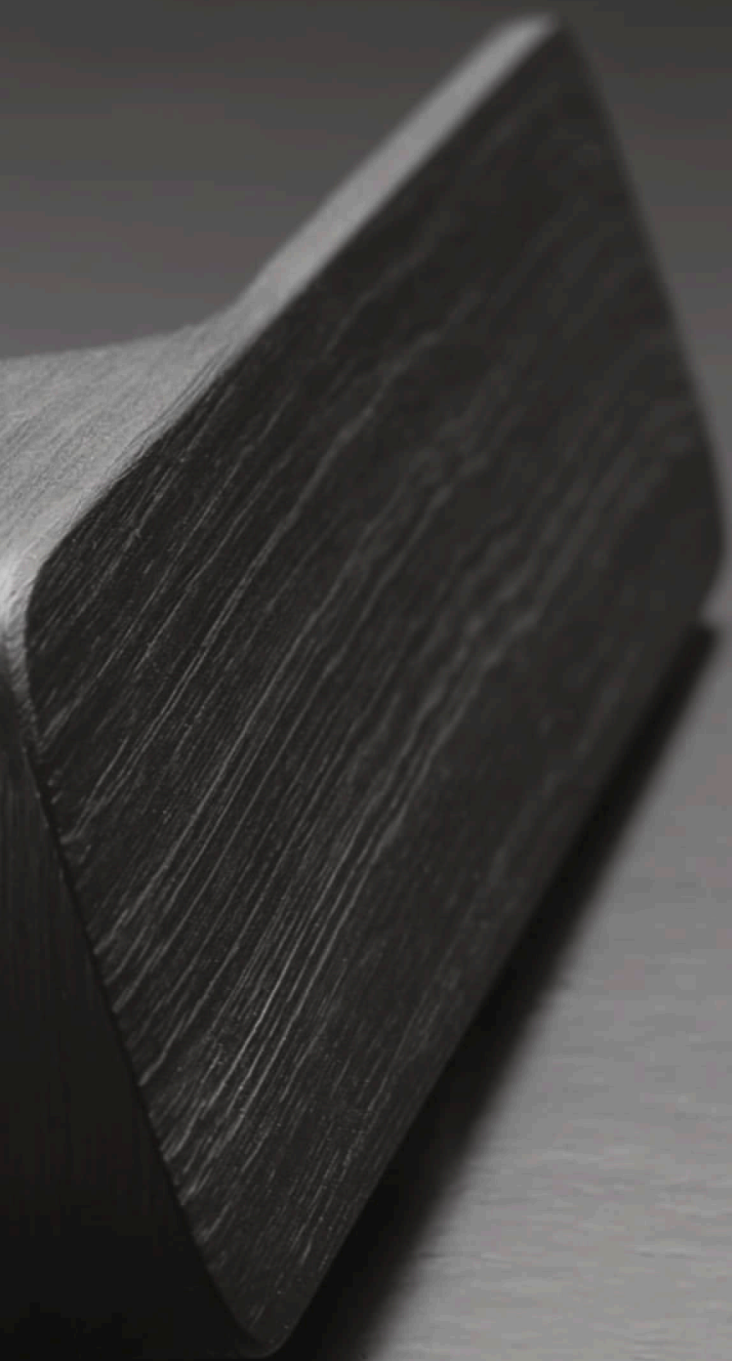

Dveřní kliky NEREZ [30 – 41]



Dveřní kliky DESIGN 2018 - Rocksor, Industry Squelette [152 – 173]



Dveřní kliky NEREZ + magnetické rozety [42 – 75]



Dveřní kliky DESIGN 2021 - Up & Down [174 – 179]



Dveřní kliky DESIGN 2000, 2004 [76 – 87]



Štitové kování NEREZ, DESIGN 2000, 2004 [180 – 195]



Dveřní kliky DESIGN 2006 [88 – 91]



Bezpečnostní kování, Bezpečnostní madla Entero [196 – 205]



Dveřní kliky DESIGN 2009 [92 – 99]



Bezpečnostní rozety [206 – 213]



Dveřní kliky DESIGN 2011 řada MINI [100 – 103]



Madla dlouhá [214 – 221]



Dveřní kliky a kování DESIGN 2013 řada MINIMAL/MAXIMAL [104 – 117]  
Dveřní kliky DESIGN 2021 MINIMAL 2.0 WC integrated [118 – 129]



Systém Magnetic [222 – 229]



Kliky + magnetické rozety DESIGN 2017 [130 – 151]



Ovládací madla k systému Magnetic [230 – 257]



Okenní kliky 3 a 4 polohové [258 – 265]



Madla a koule na skleněné a dřevěné dveře [328 – 333]



Okenní kliky 225, 250 mm / HS Portaly na posuvná okna a stěny [266 – 273]



Posuvný systém MINIMA pro dřevěné a skleněné dveře [334 – 341]



Kování pro hliníkové a ocelové dveře, kování na branky [274 – 285]



Neviditelné zárubně MINIMA [342 – 347]



Mušle na posuvné dveře [286 – 303]



Soklový systém SOCLICK [348 – 359]



Mušle Minimal / Maximal na skleněné posuvné dveře [304 – 307]



Magnetické zámky [360 – 363]



Kliky a zámky na skleněné dveře [308 – 317]



Panty na dřevěné dveře [364 – 367]



Panty na skleněné dveře [318 – 321]



Dveřní zarážky [368 – 373]



Nerezové kliky, zámky a panty na skleněné dveře [322 – 327]



Montážní PROFI šablona [374 – 375]



Příslušenství a komponenty [376 – 379]



Dveřní kliky NEREZ

Dveřní kliky NEREZ + magnetické rozety

Dveřní kliky DESIGN 2000, 2004

Dveřní kliky DESIGN 2006

Dveřní kliky DESIGN 2009

Dveřní kliky DESIGN 2011 řada MINI

Dveřní kliky a kování DESIGN 2013 řada MINIMAL/MAXIMAL  
Dveřní kliky DESIGN 2021 MINIMAL 2.0 WC integrated

Kliky + magnetické rozety DESIGN 2017

Dveřní kliky DESIGN 2018 - Rocksor, Industry Squelette

Dveřní kliky DESIGN 2021 - Up & Down

Štítové kování NEREZ, DESIGN 2000, 2004

Bezpečnostní kování, Bezpečnostní madla Entero

Bezpečnostní rozety

Madla dlouhá

Systém Magnetic

Ovládací madla k systému Magnetic

Okenní kliky 3 a 4 polohové

Okenní kliky 225, 250 mm / HS Portaly na posuvná okna a stěny

Kování pro hliníkové a ocelové dveře, kování na branky

Mušle na posuvné dveře

Mušle Minimal / Maximal na skleněné posuvné dveře

Kliky a zámky na skleněné dveře

Panty na skleněné dveře

Nerezové kliky, zámky a panty na skleněné dveře

Madla a koule na skleněné a dřevěné dveře

Posuvný systém MINIMA pro dřevěné a skleněné dveře

Neviditelné zárubně MINIMA

Soklový systém SOCLICK

Magnetické zámky

Panty na dřevěné dveře

Dveřní zarážky

Montážní PROFI šablona

Příslušenství a komponenty

Dveřní kliky NEREZ

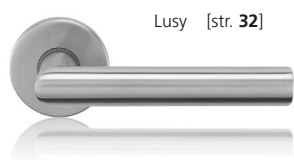

Lusy [str. 32]



Deny [str. 32]



Hanna [str. 40]



Senza [str. 34]



Promo [str. 34]



Entero [str. 34]



Lusy [str. 36]



Deny [str. 36]



Meclis [str. 36]



Senza [str. 38]



Promo [str. 38]



Entero [str. 38]

Dveřní kliky NEREZ + magnetické rozety

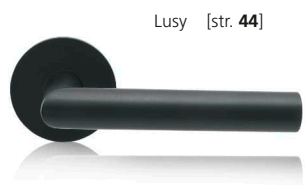

Lusy [str. 44]



Deny [str. 44]



Meclis [str. 46]



Morgan [str. 46]



Jameson [str. 48]



Nova [str. 48]



Promo [str. 50]



Senza [str. 50]



Entero [str. 52]



Kvadra [str. 52]



Techno [str. 54]



Sonia [str. 56]



Morgan [str. 32]



Jameson [str. 32]



Nova [str. 32]



Kvadra [str. 34]



Techno [str. 34]



Cesan [str. 34]



Morgan [str. 36]



Jameson [str. 36]



Nova [str. 36]



Kvadra [str. 38]



Techno [str. 38]

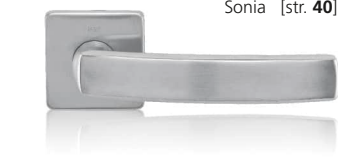

Sonia [str. 40]



Lusy [str. 60]



Deny [str. 60]



Morgan [str. 62]



Hanna [str. 56]

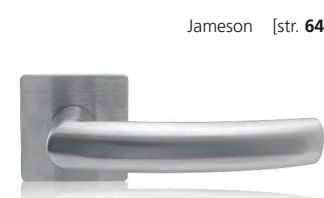

Jameson [str. 64]



Nova [str. 64]



Promo [str. 66]



Senza [str. 66]



Kvadra [str. 68]



Entero [str. 68]



Sonia [str. 72]



Cesan [str. 70]

Kliky + magnetické rozety  
materiál: masivní mosaz 

Cesan [str. 134]



Entero [str. 134]

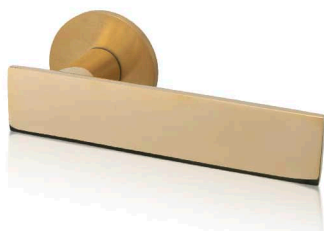

Burak [str. 136]



Andy [str. 136]



Sogut [str. 138]



Cherez [str. 138]



Entero [str. 146]



Entero [str. 146]



Dveřní kliky DESIGN 2000  
materiál: masivní mosaz 

Cesan [str. 78]



Garanti [str. 78]



Burak [str. 78]



Kemer [str. 80]



Deny [str. 80]



Lusy [str. 80]



Dveřní kliky DESIGN 2004  
materiál: masivní mosaz 

Entero madlo [str. 84]



Entero [str. 84]



Lara [str. 84]



Garanti [str. 84]



Cherez [str. 86]



Mondeo [str. 86]





Entero [str. 134]



Lusy [str. 140]



Deny [str. 140]



Lusy [str. 144]



Sogut [str. 146]



Lusy [str. 144]



Deny [str. 144]



Fábi [str. 78]



Andy [str. 78]



Mondeo [str. 78]



Maty [str. 80]



Mia [str. 82]



Sogut [str. 82]



Meclis [str. 82]

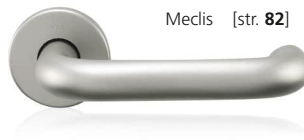

Cherez [str. 82]



Garanti [str. 84]



Sogut [str. 84]



Sogut [str. 84]



Lusy [str. 84]



Deny [str. 86]



Dveřní kliky DESIGN 2006  
materiál: masivní mosaz 

Entry [str. 90]

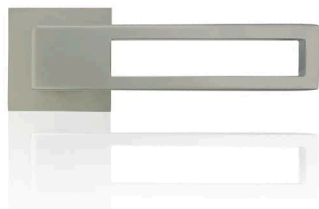

Trinity [str. 90]

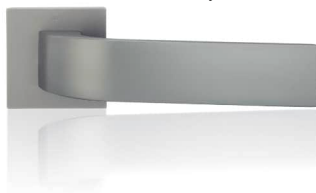

My [str. 90]



Terry [str. 90]



Entero [str. 90]



Entry [str. 90]



Dveřní kliky DESIGN 2011  
materiál: masivní mosaz 

Mini-V [str. 102]



Mini-C [str. 102]



Mini-S [str. 102]



Mini-T [str. 102]

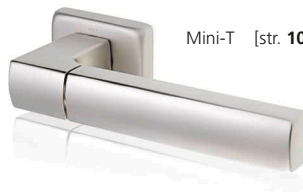

Dveřní kliky DESIGN 2009  
materiál: masivní mosaz 

Tukan [str. 94]

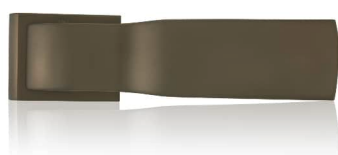

Maya [str. 94]



Toro [str. 94]



Mimolimit [str. 96]



Dveřní kliky DESIGN 2013 řada MINIMAL, MAXIMAL  
materiál: masivní mosaz 

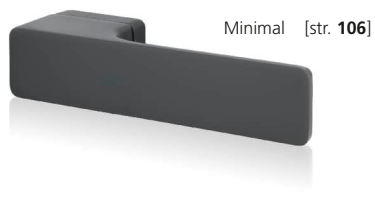

  
reddot design award  
winner  
mezinárodní prestižní ocenění za design

Dveřní kliky DESIGN 2021 řada MINIMAL 2.0  
materiál: masivní mosaz 

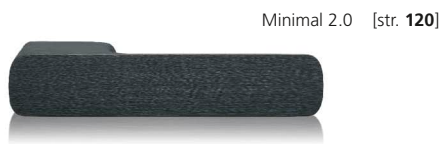

Dveřní kliky DESIGN 2021 řada MINIMAL 2.0 WC integrated  
materiál: masivní mosaz 



Dveřní kliky DESIGN 2018 Rocksor  
materiál: masivní mosaz 

Rocksor [str. 154]



Rocksor [str. 154]



Rocksor U [str. 154]



Rocksor [str. 154]



Rocksor [str. 154]



Rocksor [str. 158]



madlo Rocksor [str. 154]



Dveřní kliky DESIGN 2018 Industry Squelette  
materiál: nerezová ocel

Industry Squelette [str. 165]

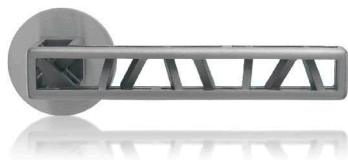

Industry Squelette [str. 164]



madlo Industry Squelette [str. 164]

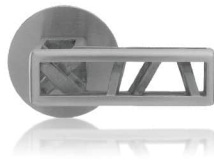

Industry Squelette [str. 165]



Industry Squelette [str. 164]



Industry Squelette [str. 164]



Industry Squelette [str. 168]



Dveřní kliky DESIGN 2021 Up  
materiál: masivní mosaz 

Up [str. 176]



Up [str. 176]



Up [str. 176]



Up [str. 176]



Up [str. 176]



Dveřní kliky DESIGN 2021 Down  
materiál: masivní mosaz 

Down [str. 176]



Down [str. 176]



Down [str. 176]



Down [str. 176]

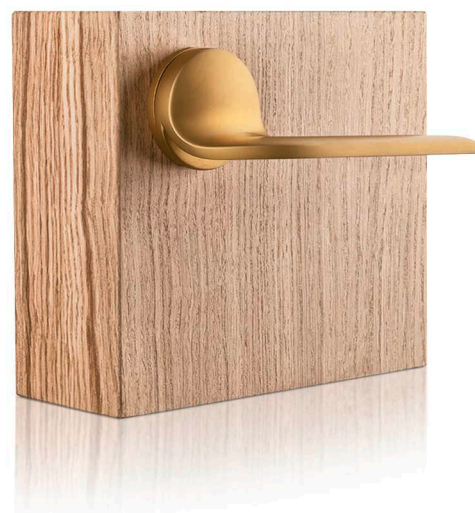

# POVRCHY

Jsme lídři v povrchových úpravách



Bílá mat

Nikl satén mat

Chrom lesk

Titan chrom mat

Mosaz leštěno

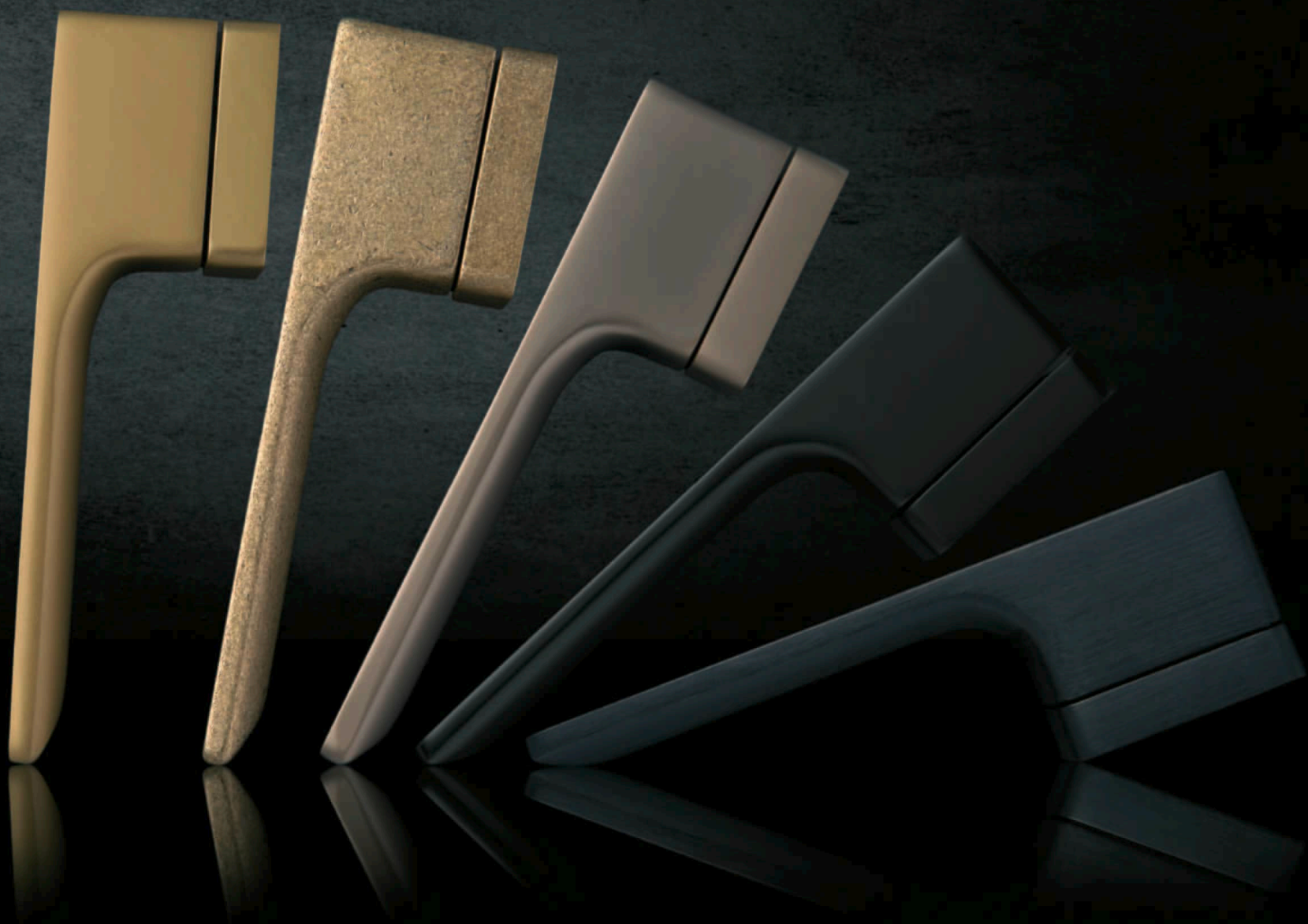

Titan mosaz mat

Mosaz natural

Titan braun mat

Titan černý mat

Chrom černý 3D broušeno

# Barvy & povrchy

JSME LÍDŘI V POVRCHOVÝCH ÚPRAVÁCH



## Novinky

### Ms-D mosaz staré dřevo

Technologicky upravený povrch na mosazném výrobku s efektem starého dřeva, ručně broušenou 3D strukturou. Skvělá investice s doživotní zárukou.

- termín výroby .. 4 - 8 týdnů
- záruka .. doživotní !
- použití ... interiéry i exteriéry
- údržba .. bezúdržbové, bavlněný hadřík, popř. prostředek SITOL

### TiN-M titan měď broušeno

Fyzikálně naprašovaný povrch s předúpravou - ručně broušenou 3D strukturou. Měděný odolný povrch vhodný do interiéru i exteriéru.

- termín výroby .. 4 - 8 týdnů
- záruka .. 15 let
- použití ... interiéry i exteriéry
- údržba .. prostředek M&T TITAN
- množství podmínka ... pouze pro zakázky nad 50 párů kování



### Sni matný nikel

Galvanické pokovení na mosazný výrobek se sametově jemným povrchem

- termín výroby .. 2 - 4 týdny
- záruka .. 3 roky
- použití ... interiéry
- údržba .. prostředek M&T SNI čistič nebo SITOL

### SNi-broušeno matný nikel broušený

Galvanické pokovení na mosazný výrobek s ručně broušeným povrchem

- termín výroby .. 2 - 4 týdny
- záruka .. 3 roky
- použití ... interiéry
- údržba .. prostředek M&T SNI čistič nebo SITOL

### Cr lesklý chrom

Galvanické pokovení na mosazný výrobek s vysoce lesklým povrchem

- termín výroby .. 3 - 4 týdny
- záruka .. 3 roky
- použití ... interiéry i exteriéry
- údržba .. bavlněný hadřík, popř. prostředek SITOL



### Ms mosaz natural

Mechanicky upravený povrch na mosazném výrobku s jemnou strukturou a barevností, která se citlivě doplňuje s přírodním dřevem ať původním nebo moderním strukturovaným. Povrch bude přirozeně stárnout s okolním materiálem a měnit svoji barevnost podle klimatických podmínek. Skvělá investice s doživotní zárukou.

- termín výroby .. 3 - 4 týdny
- záruka .. doživotní !
- použití ... interiéry i exteriéry
- údržba .. bezúdržbové, bavlněný hadřík, popř. prostředek SITOL

### Ms-L mosaz leštěno

Mechanicky ručně leštěný povrch na mosazném výrobku s vysoce lesklým povrchem, který postupně získává patinu a matovatí. Povrch přirozeně stárne a mění svoji barevnost a vzhled i podle frekvence otevírání - na frekventovaných místech zůstane lesklý, jinde bude matný s tmavším odstínem. Každý kus je originál s jiným procesem stárnutí a jinou vzhledovou barevností. Skvělá investice s doživotní zárukou.

- termín výroby .. 3 - 4 týdny
- záruka .. doživotní !
- použití ... interiéry i exteriéry
- údržba .. bezúdržbové, bavlněný hadřík, popř. prostředek SITOL

### Ms-A mosaz antik

Technologicky upravený povrch na mosazném výrobku s efektem několika let používané mosazi, tzn. žlutá mosaz je místy tmavá, místy světlejší s efektem „osahané“ mosazi. Povrch bude dále přirozeně stárnout s okolním materiálem a měnit svoji barevnost podle klimatických podmínek. Skvělá investice s doživotní zárukou.

- termín výroby .. 4 - 8 týdnů
- záruka .. doživotní !
- použití ... interiéry i exteriéry
- údržba .. bezúdržbové, bavlněný hadřík, popř. prostředek SITOL



### TiN-C titan chrom mat

Fyzikálně naprašovaný povrch s nejširším využitím, který díky svému ocelově šedo/modrému kovovému odstínu, dokáže najít využití v širokém spektru staveb a projektů s důrazem na prvotřídní kvalitu a design. Tento povrch je zároveň nejtvrdějším a nejdolnějším povrchem z celé nabídky titanových povrchů a tím je přímo předurčen pro použití v exteriérech a maximálně zatěžovaných prostorech.

- termín výroby .. 4 - 8 týdnů
- záruka .. 15 let
- použití ... interiéry i exteriéry
- údržba .. prostředek M&T TITAN

### TiN-K titan černý mat

Fyzikálně naprašovaný povrch s nejdelší tradicí - to je černý titan, který aplikujeme na své výrobky už od r. 2000. Za tuto dobu získal tento povrch mnoho příznivců, převážně investorů high staveb a interiéru, kam je svým odstínem předurčen. Nejedná se o běžnou černou barvu, ale o metalický šedo/černý odstín, který ihned zaujme svoji strukturou a nezaměnitelným kovovým odstínem.

- termín výroby .. 4 týdny
- záruka .. 15 let
- použití ... interiéry i exteriéry
- údržba .. prostředek M&T TITAN

### TiN-B titan braun mat

Fyzikálně naprašovaný povrch vyvinut speciálně pro řadu kování DESIGN 2009. Měníci se povrch přecházející přes spektrum hnědých odstínů a končící na hranách klik až u hluboké tmavé barvy lze jen těžko definovat. Od uvedení na trh v roce 2009 si získává stále větší oblibu převážně u architektů a zákazníků s citem pro pokročilý design.

- termín výroby .. 4 - 8 týdnů
- záruka .. 15 let
- použití ... interiéry i exteriéry
- údržba .. prostředek M&T TITAN
- množství podmínka ... pouze pro zakázky nad 50 párů kování





### TiN-S titan bronz mat

Fyzikálně naprašovaný povrch požadovaný všude tam, kde je důraz na tradici, souznění se dřevem, popř. jinými naturálními materiály, dodávající realizacím patřičný genius loci.

- termín výroby .. 4 - 8 týdnů
- záruka .. 15 let
- použití ... interiéry i exteriéry
- údržba .. prostředek M&T TITAN
- množstevní podmínka ... pouze pro zakázky nad 50 párů kování

### TiN-A titan mosaz mat

Fyzikálně naprašovaný povrch s ne náhodnou podobností s naturální mosaznou klikou, dříve ve velké míře používanou a u M&T znovu zařazenou do nabídky. Žluto/zlatý odstín je nadstandardním řešením všude tam, kde je požadavek na sladění celku v barvě mosazi, či zlata.

- termín výroby .. 4 - 8 týdnů
- záruka .. 15 let
- použití ... interiéry i exteriéry
- údržba .. prostředek M&T TITAN
- množstevní podmínka ... pouze pro zakázky nad 50 párů kování

### Cr-K černý chrom broušený 3D

Galvanické pokovení na mosazný výrobek s předupraveným povrchem s jemnou ručně broušenou 3D strukturou, která splňuje náročné požadavky na moderní architekturu, ale zároveň i na stylové tradiční stavby. Matný černý povrch té nejvyšší kvality.

- termín výroby .. 4 - 6 týdnů
- záruka .. 5 let
- použití ... interiéry i exteriéry
- údržba .. bezúdržbové, bavlněný hadřík, popř. prostředek SITOL



### NRz nerez - broušeno

Mechanicky ručně broušený povrch na nerezovém výrobku s jemnou broušenou strukturou.

- termín výroby .. 7 pracovních dnů pro rozetové kování, ostatní sortiment nerez 3 - 4 týdny
- záruka .. 5 let
- použití ... interiéry i exteriéry
- údržba .. bezúdržbová, popř. prostředek M&T TITAN

### K-industrial černý mat strukturovaný

Naprašovaný tvrzený povrch s hrubou strukturou navazující na industriální období přelomu 19. a 20. století. Předností povrchu je nejen nezaměnitelný vzhled, ale i velmi příjemný dotykový dojem. Povrch je prioritně připraven pro všechny produkty z nerezové oceli, lze nanášet i na mosazné výrobky.

- termín výroby .. 4 týdny
- záruka .. 5 let
- použití ... interiéry i exteriéry
- údržba .. prostředek M&T TITAN

### Wh bílá mat

Stříkaný vypalovaný povrch v odstínu RAL 9003, matný. Stříkaný povrch má své limity – nejedná se o kovovou vrstvu jako u všech dalších povrchů M&T. U povrchu nelze garantovat odolnost proti poškrábání prstýnkou, nebo jinými ostrými předměty. Povrch není vhodný do komerčních prostor a ke dveřím s vysokou frekvencí ovládání.

- termín výroby .. 4 - 8 týdnů
- záruka .. 2 roky, bez záruky proti poškrábání ostrými předměty
- použití ... interiéry s nízkou frekvencí ovládání
- údržba .. navlhčený bavlněný hadřík

## Vzorkovnice povrchů

### PŘEHLEDNÁ VZORKOVNICE VŠECH POVRCHŮ A BAREV NA KOVÁNÍ M&T

Kování M&T vyrábíme ze dvou kvalitních materiálů – nerezové oceli a masivní mosazi. Každý materiál má svoje specifické vlastnosti, které nám umožňují připravit výrobky s finální povrchovou úpravou ve velké variabilitě pro maximální komfort zákazníků. Objevte všechny možnosti, které Vám nabízíme a staňte se architekty svého vlastního projektu.

U každého povrchu máte přehledné informace o základním materiálu, výrobní technologii, termínu výroby, délce záruky, způsobu použití a údržbě. Všechny důležité informace, které potřebujete znát, aby jste pečlivě zvolili ten správný výrobek pro Vaši plnou spokojenost. Zjistíte, že naše nabídka je velmi rozsáhlá a uspokojí i nejnáročnější zákazníky.



Garance kvality: Kliky M&T jsou vyráběny z **masivní mosazi** nebo **nerezové oceli**. Žádná klika z naší nabídky není vyrobena z levného a porézního materiálu ZAMAK, hliník.

## Údržba a ochrana klik

Kliky nenechávejte vlhké (převážně v koupelnách a na toaletách). Z odpařované vody se na povrchu klik vysrážejí a po té zůstávají minerální soli, které způsobují skvrny odlišné barvy. Tyto nečistoty lze účinně odstranit vygumováním školní gumou, nebo použitím univerzálního čistícího přípravku SITOL. Pro povrch SNI je vhodný přípravek **M&T SNI čistí**. Předcházejte tímto skvrnám a udržujte kliky suché.

Kliky s titanovým povrchem před prvním použitím lehce přetřete bavlněným hadříkem napuštěným ochranným přípravkem **M&T TITAN** ... po té již na klice nebudou viditelné otisky prstů a povrch získá sytější kovový odstín. Doporučujeme ochranný přípravek M&T TITAN zakoupit zároveň s titanovým kovááním. Více informací na str. 379 Příslušenství a komponenty.

## Povrchy TiN

Jedinečné povrchy vznikající fyzikálním naprašováním plazmovým výbojem zaručující rovnoměrnou tenkou tvrdou vrstvu na povrchu výrobků, jsou zárukou té nejvyšší kvality na kování M&T. Nejedná se o barvu, lak, elox, ale o metalickou kovovou vrstvu ze speciálních materiálů, v různých odstínech. Jednotlivé odstíny nelze zatřít do stupnic RAL, popř. do jiných stupnic barevnosti. Pod různým úhlem, pod různým osvětlením, pod různou intenzitou se odstíny vždy mění ... jedno jim však zůstává – pořád jsou výjimečné.

Tenká vrstva 2 µm má několik předností, díky kterým je tak výjimečná:

- Mimořádná tvrdost** ... 7x tvrdší než kliky s ochranným vypalovaným lakem
- Vysoká odolnost proti oděru a poškrábání** ... nelze poškodit/poškrábat při běžném používání
- Barevnostní a chemická stálost** ... povrch ani po mnoha letech nemění původní barevný odstín
- Korozní odolnost** ... kvalitně nanášené povlaky jsou jen nepatrně mikroporézní, což zabraňuje průniku malých částic k materiálu kliky a tím tvorbě koroze.

## Nové povrchy



### **Ms-D** mosaz staré dřevo

Technologicky upravený povrch na mosazném výrobku s efektem starého dřeva, ručně broušenou 3D strukturou. Skvělá investice s doživotní zárukou.



**TiN-M** titan měď broušeno

Fyzikálně naprašovaný povrch s předúpravou - ručně broušenou 3D strukturou. Měděný odolný povrch vhodný do interiéru i exteriéru.



## Povrchy z masivní mosazi

VRACÍME SE O 100 LET ZPĚT A ZNOVU PRO VÁS OBJEVUJEME KRÁSU NATURÁLNÍ MOSAZI, MATERIÁLU S DOŽIVOTNÍ ZÁRUKOU, KTERÝ BUDE PŘIROZENĚ STÁRNOUT A MĚNIT SVOJI BARVU A CHARAKTER PODLE OKOLNÍHO PROSTORU A KLIMATICKÝCH PODMÍNEK

Od svého vzniku v roce 1997 vyrábíme kliky z masivní mosazi, které dokonale předupravujeme broušením a leštěním a po té ještě pokovujeme dalšími vrstvami různých kovů v různých barevných odstínech. I když jsou naše technologie na vysoké úrovni, všechny nanášené kovové vrstvy mají svoji životnost, která je omezená jejich tvrdostí a otěruvzdorností. Lidé si pomalu zvykají na mnoho produktů s omezenou zárukou a kratší a kratší životností, ale nemusí ...

„Připravili jsme pro Vás výrobky z materiálu s doživotní zárukou, s jednou výjimečnou vlastností - antimikrobiální účinností“



V MANUFAKTUŘE M&T V DOBRUŠCE

Je tady jedna cesta – tradiční, ale dokonalá, která už málem zapadla v zapomnění, ale my ji pomáháme oživit, protože je to cesta té nejvyšší kvality s doživotní zárukou. Ano, s doživotní zárukou. Použijeme kvalitní materiál masivní mosaz v naturálním stavu, kterou pouze mechanicky upravíme, tak jako naši předci před mnoha lety a dále už necháme materiál přirozeně stárnout, stejným způsobem jako stárnou všechny mosazné výrobky na všech tradičních stavbách po celém světě.



MOSAZ LEŠTĚNO **Ms-L**

MOSAZ NATURAL **Ms**



MOSAZ ANTIK **Ms-A**



MOSAZ STARÉ DŘEVO **Ms-D**

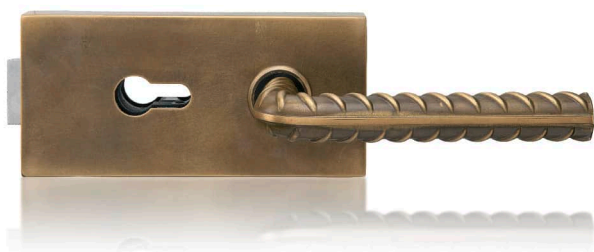



**Ms-A** mosaz antik  
(proces urychleného stárnutí  
pro vzhled „dlouhodobě používané kliky“)



**Ms** mosaz natur  
(mechanicky upravený povrch s jemnou strukturou,  
která postupně tmavne)



**Ms-L** mosaz leštěno  
(ručně leštěný povrch do vysokého lesku, který postupně matovává  
a získává přirozenou patinu)



**Ms-D** mosaz staré dřevo  
(technologicky upravený povrch na mosazném výrobku  
s efektem starého dřeva, ručně broušenou 3D strukturou)





## Nové povrchy z masivní mosazi

Od roku 1997 vyrábíme dveřní kliky z masivní mosazi. Mosaz je velmi kvalitní materiál, má řadu předností a také jednu zásadní vlastnost, která zůstávala skoro bez povšimnutí až do roku 2020 ...

**Masivní mosaz s velkým obsahem mědi**, kterou používáme více jak 20 let při výrobě produktů M&T, čini z těchto finálních výrobků **vysoce antimikrobiální produkt**, velmi rychle a účinně likvidující veškeré bakterie a viry zachycené na svém povrchu, několikanásobně rychleji než materiály a povrchy obsahující stříbro, které jsou známé jako výkonný zabíječ bakterií.

Všechny produkty M&T označené materiálem: **masivní mosaz**, obsahují minimálně 60% mědi a jsou dokonalým likvidátorem všech virů a bakterií. V nabídce M&T se jedná o provedení

**Ms-L** mosaz leštěno  
**Ms** mosaz natur  
**Ms-A** mosaz antik

Antimikrobiální produkty M&T:  
dveřní kliky, madla a koule pevné, dlouhá madla  
mušle, zámků a kliky na skleněné dveře, okenní kliky, HS Portaly

Více informací o antimikrobiálních/antibakteriálních vlastnostech výrobků z mědi, včetně mezinárodních vědeckých studií a materiálových protokolů získáte na [www.kliky-mt.cz/mt-news/antimikrobialni-kliky/](http://www.kliky-mt.cz/mt-news/antimikrobialni-kliky/)





Antimikrobiální  
Antibakteriální  
materiál

Jedinečná vlastnost masivní mosazi s velkým obsahem mědi



## Černá je in

ČERNÉ MATNÉ KLIKY S VYSOCE KVALITNÍM TITANOVÝM POVRCHEM JSME TECHNOLOGICKY A VÝROBNĚ OVLÁDLI UŽ V ROCE 2000, ALE TEPRVE NYNÍ ZAČÍNÁ BÝT TEN PRAVÝ BOOM TOHOTO UNIKÁTNÍHO POVRCHU

Neustále se snažíme inovovat naše výrobky a to je i jeden z důvodů proč již od roku 2000 aplikujeme na své produkty titanové povrchy. I přesto, že se jedná o velmi komplikovanou technologii s mnoha aspekty a požadavky na dokonalé předúpravy, můžeme říci, že tyto povrchy umíme na naše výrobky aplikovat ve více barevných odstínech technologií fyzikálního naprašování nízkotlakým plazmovým výbojem.

Tenká vrstva 2  $\mu\text{m}$  má několik předností, díky kterým je tak výjimečná. Především je to mimořádná tvrdost, vysoká odolnost proti oděru a poškrábání, barevná a chemická stálost, korozní odolnost. U těchto povrchů povlakuje speciálně zakázku po zakázce v dodacích termínech, které jsou součástí této výjimečné technologie s výrobou do max. 4 týdnů.

# TIN-K

„Černý matný titanový povrch a černý matný chrom je v současnosti nejprestižnějším možným designovým prvkem na produktech v interiéru i exteriéru“



TITAN ČERNÝ MAT **TIN-K**

Černá je kontrastem bílé a přesně to se od této barvy očekává v minimalistických interiérech i exteriérech, kde je kladen velký důraz na detail produktů mezi které patří svítidla, baterie a samozřejmě také dveřní kování. Není to ale pouze kombinace s bílou barvou, kde nachází černé matné kování uplatnění.

Velmi žádané jsou nyní přírodní dřevěné materiály právě s kombinací s černým matným povrchem. Nechte se inspirovat tímto povrchem, který má široké uplatnění ve všech projektech té nejvyšší kategorie.



TERRY TiN-K  
titan černý mat



MINIMAL II TiN-K  
titan černý mat



CESAN TiN-K  
titan černý mat



Magnetický zámek  
černý mat

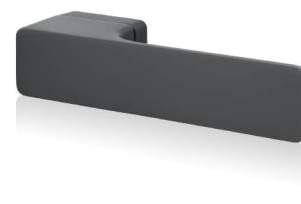

MINIMAL TiN-K  
titan černý mat





**Entero**



**Burak**

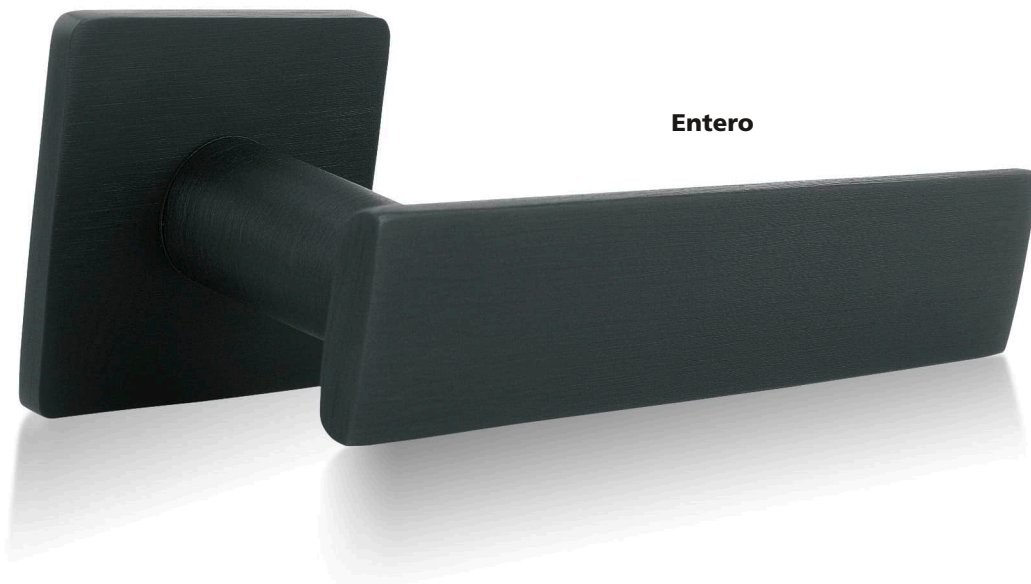

**Entero**



**Entry**

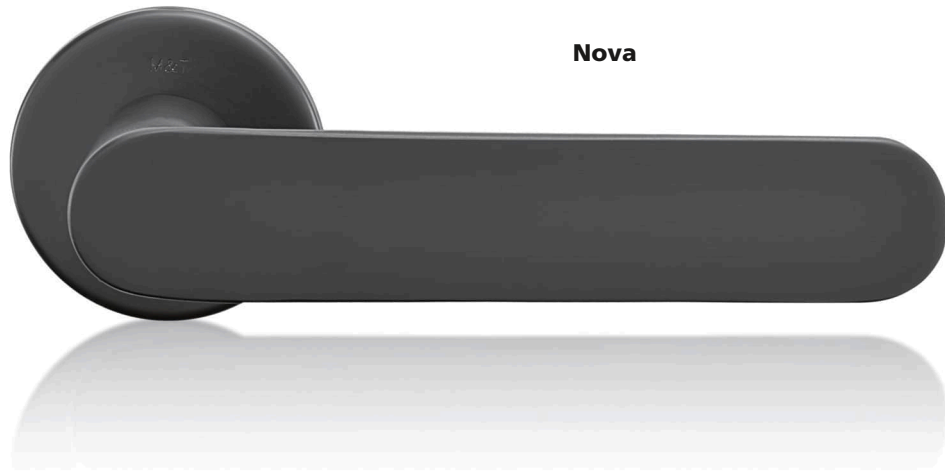

**Nova**

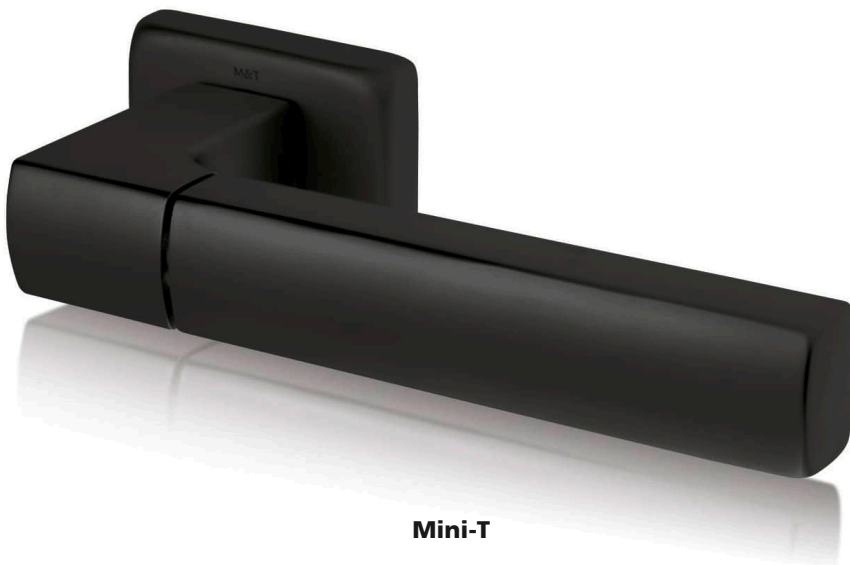

**Mini-T**



**Mini-S**

## TIN-K

černý matný kovový povrch

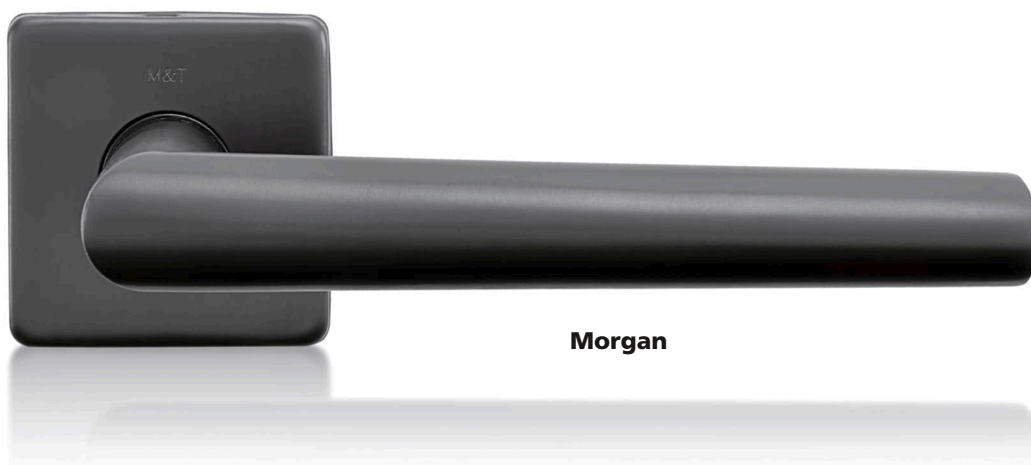

**Morgan**



**Cesan**



**Terry**



**Sogut**

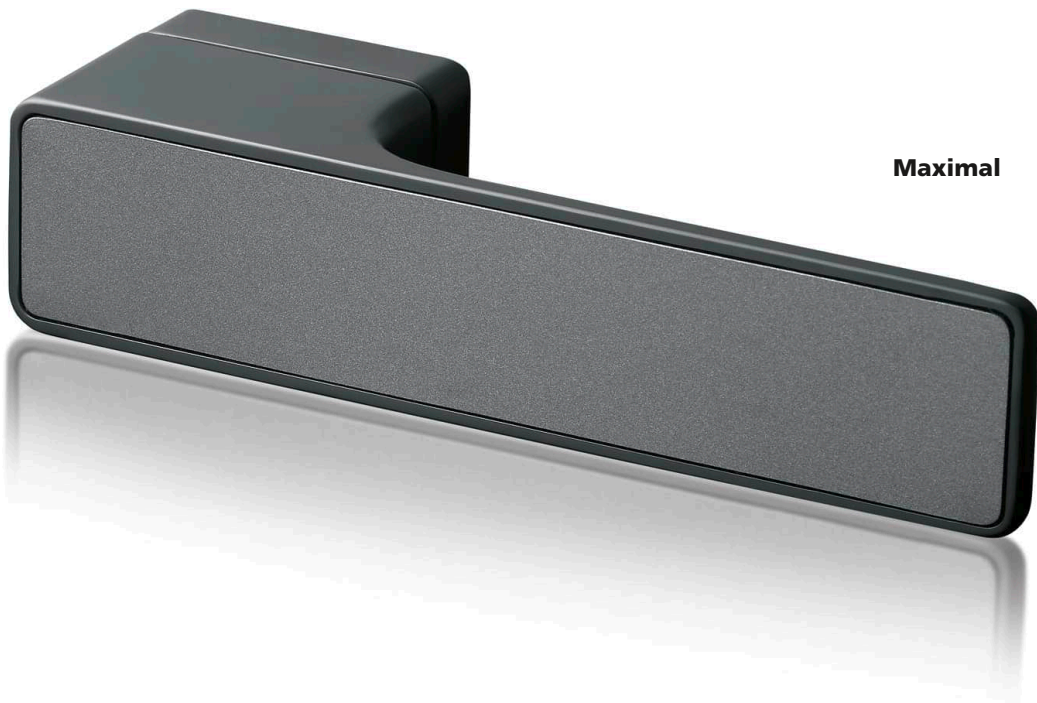

**Maximal**



**Deny**



**Minimal**



**Sogut**

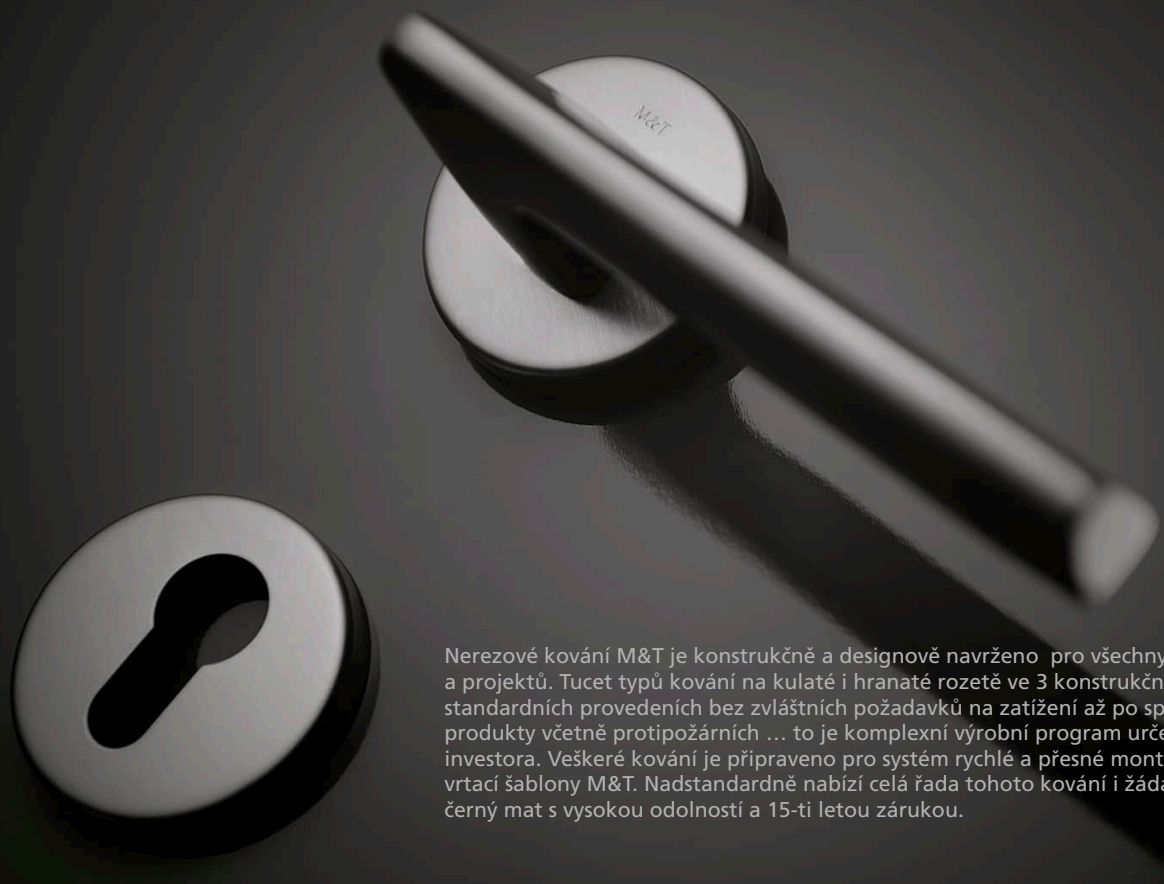

Nerezové kování M&T je konstrukčně a designově navrženo pro všechny typy staveb a projektů. Tucet typů kování na kulaté i hranaté rozetě ve 3 konstrukčních variantách od standardních provedeníh bez zvláštních požadavků na zatížení až po speciální projektové produkty včetně protipožárních ... to je komplexní výrobní program určený pro každého investora. Veškeré kování je připraveno pro systém rychlé a přesné montáže pomocí PROFÍ vrtací šablony M&T. Nadstandardně nabízí celá řada tohoto kování i žádaný povrch TiN-K titan černý mat s vysokou odolností a 15-ti letou zárukou.

Ochranná známka – registrovaná značka **ENTERO®**

Chráněné průmyslové vzory klik

**MORGAN  
TECHNO  
ENTERO  
SENZA  
PROMO  
NOVA**

Celý projekt - jeden design

Dveřní kliky NEREZ



Nerezové kliky, zámky a panty na skleněné dveře



Mušle na posuvné dveře



Okenní kliky 3 a 4 polohové



Štitové kování NEREZ



Madla dlouhá



Kování pro hliníkové a ocelové dveře, kování na branky



Bezpečnostní rozety



Madla a koule na skleněné a dřevěné dveře



## Dveřní kliky NEREZ

Materiál: nerezová ocel ANSI 304

Povrchy: NRz nerez - broušeno, TiN-K titan černý mat, K-industrial černý mat strukturovaný

LUSY NRz nerez ocel broušeno

MORGAN TiN-K titan černý mat

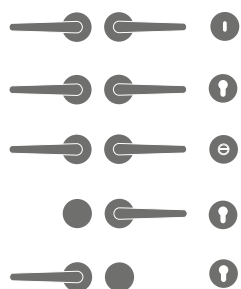
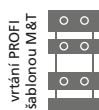

Klika/klika + rozety kulaté dozické

Klika/klika + rozety kulaté cylindrické

Klika/klika + rozety kulaté WC

Koule/klika R + rozety kulaté cylindrické

Koule/klika L + rozety kulaté cylindrické

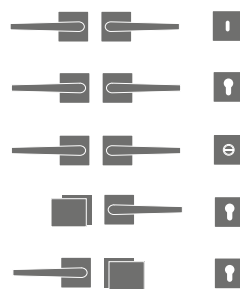

Klika/klika + rozety čtvercové dozické

Klika/klika + rozety čtvercové cylindrické

Klika/klika + rozety čtvercové WC

Madlo/klika R + rozety čtvercové cylindrické

Madlo/klika L + rozety čtvercové cylindrické



dozické

cylindrické

WC in

WC ex

zaslepovací

rozety Ø 52 mm



dozické

cylindrické

WC in

WC ex

zaslepovací

rozety 52x52 mm

konstrukční varianty, materiálové provedení

koule Maty



koule Maty vyosená



madlo Entero



### Economy

- kování s vratnou pružinou
- sada včetně spodních rozet
- sešroubování pouzdry proti sobě
- plastové podrozety
- vrtání PROFI šablonou M&T vrtákem Ø 6,4 mm
- animace montáže na [www.kliky-mt.cz/montaze-kovani](http://www.kliky-mt.cz/montaze-kovani)
- kategorie použití - třída 3
- záruka 5 let, titan 15 let
- montáž pro tloušťku dveří 38 - 126 mm
- v balení montážní materiál pro tl. dveří 38 - 45 mm

### Objekt

- kování s vratnou pružinou
- sada včetně spodních rozet s pouzdry
- sešroubování pouzdry proti sobě
- kovové podrozety u kliky
- zajišťovací gel proti uvolnění šroubů
- vrtání PROFI šablonou M&T vrtákem Ø 6,4 mm
- kategorie použití - třída 3
- záruka 5 let, titan 15 let
- montáž pro tloušťku dveří 38 - 126 mm
- v balení montážní materiál pro tl. dveří 38 - 45 mm

### Projekt tř. 4

- kování s vratnou pružinou
- sada včetně spodních rozet s pouzdry
- sešroubování pouzdry proti sobě
- kovové podrozety u kliky
- celonerezové provedení vč. krčku
- nerezový čtyřhran
- nerezový červík
- zajišťovací gel
- vrtání PROFI šablonou M&T vrtákem Ø 6,4 mm
- záruka 7 let, titan 15 let
- montáž pro tloušťku dveří 38 - 126 mm
- v balení montážní materiál pro tl. dveří 38 - 45 mm

Zatřídění kování podle normy EN 1906:2012, ČSN EN 1906 16 5776

Prohlášení o shodě na [www.kliky-mt.cz/certifikaty](http://www.kliky-mt.cz/certifikaty)

Economy **26-0030B**

**2** Kategorie použití .. střední frekvence používání lidmi, kteří jsou motivováni používat je pečlivě, ale kde je určitá pravděpodobnost nesprávného použití, např. vnitřní dveře kanceláří

**6** Životnost .. střední frekvence používání: 100 000 cyklů

**-** Hmotnost dveří .. (bez klasifikace)

**0** Požární odolnost .. (není požadována odolnost)

**0** Ochrana .. normální použití

**3** Odolnost proti korozi .. vysoká odolnost

**0** Bezpečnost .. odolnost není definována

**B** Typ ovládání .. kování s vratnou pružinou

Objekt **36-0031B**

**3** Kategorie použití .. vysoká frekvence používání veřejností nebo jinými uživateli s malou motivací o pečlivé používání a kde je vysoká pravděpodobnost nesprávného použití, např. dveře u veřejných kanceláří

**6** Životnost .. střední frekvence používání: 100 000 cyklů

**-** Hmotnost dveří .. (bez klasifikace)

**0** Požární odolnost .. (není požadována odolnost)

**0** Ochrana .. normální použití

**3** Odolnost proti korozi .. vysoká odolnost

**1** Bezpečnost .. mírná odolnost proti vloupání

**B** Typ ovládání .. kování s vratnou pružinou

Projekt tř. 4 **47-D1141B**

**4** Kategorie použití .. vysoká frekvence používání na dveřích, které jsou předmětem častého hrubého používání, např. fotbalové stadiony, kasárna, veřejné toalety, atd.

**7** Životnost .. vysoká frekvence používání: 200 000 cyklů

**-** Hmotnost dveří .. (bez klasifikace)

**D1** Požární odolnost .. pro použití na kouřotěsných a požárně odolných dveřích s požadavky na speciální střed v klíče/knoflíku, zkušenných s 200000 cykly na zkušebních dveřích.

**1** Ochrana .. použití v situacích vyžadujících ochranu

**4** Odolnost proti korozi .. velmi vysoká odolnost

**1** Bezpečnost .. mírná odolnost proti vloupání

**B** Typ ovládání .. kování s vratnou pružinou



### Lusy

590,- Kč  
25,- EUR



### Deny

590,- Kč  
25,- EUR



### Meclis

730,- Kč  
31,- EUR



### Morgan

730,- Kč  
31,- EUR



### Jameson

880,- Kč  
37,- EUR

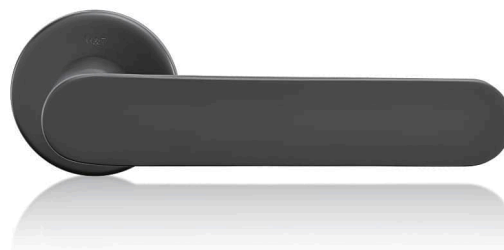

### Nova

1180,- Kč  
50,- EUR

**Economy nerez**  
materiál: nerezová ocel  
povrch: NRz nerez - broušeno

Kč			EUR
590,-			25,-
590,-			25,-
1020,-			43,-
1320,-			55,-
1320,-			55,-
590,-			25,-
590,-			25,-
1020,-			43,-
1320,-			55,-
1320,-			55,-
730,-			31,-
730,-			31,-
1180,-			50,-
1460,-			61,-
1460,-			61,-
730,-			31,-
730,-			31,-
1180,-			50,-
1460,-			61,-
1460,-			61,-
880,-			37,-
880,-			37,-
1320,-			55,-
1620,-			68,-
1620,-			68,-
1180,-			50,-
1180,-			50,-
1620,-			68,-
1910,-			80,-
1910,-			80,-

Provedení panikové pro zámky s děleným čtyřhranem je s příplatkem 200,- Kč (EAN 101416) k ceně cylindrického provedení. Dělený čtyřhran se objednává zvlášť a je třeba specifikovat přesnou délku čtyřhranu, str. 377.



Veškeré uváděné ceny v celém katalogu / ceníku jsou bez DPH.

		Economy nerez		Objekt nerez		Objekt titan		Objekt		Projekt tř. 4, (i protipožární)		Projekt tř. 4, (i protipožární)	
		NRz		NRz		TiN-K		K-industrial		NRz		TiN-K	
		cena / pár	EAN	cena / pár	EAN	cena / pár	EAN	cena / pár	EAN	cena / pár	EAN	cena / pár	EAN
dozické	Kč €	590,- 25,-	79861	880,- 37,-	39100	1180,- 50,-	013290	1180,- 50,-	030976	1180,- 50,-	013344	2190,- 92,-	013399
cyklindrické	Kč €	590,- 25,-	79878	880,- 37,-	39117	1180,- 50,-	013306	1180,- 50,-	030983	1180,- 50,-	013351	2190,- 92,-	013405
WC	Kč €	1020,- 43,-	79885	1320,- 55,-	39124	1910,- 80,-	013313	1910,- 80,-	030990	1620,- 68,-	013368	2780,- 116,-	013412
koule / klika R	Kč €	1320,- 55,-	79892	1620,- 68,-	013276	2780,- 116,-	013320	2780,- 116,-	031003	1910,- 80,-	013375	3070,- 128,-	013429
koule / klika L	Kč €	1320,- 55,-	79908	1620,- 68,-	013283	2780,- 116,-	013337	2780,- 116,-	031010	1910,- 80,-	013382	3070,- 128,-	013436
dozické	Kč €	590,- 25,-	79960	880,- 37,-	013245	1910,- 80,-	013467	1910,- 80,-	031027	1180,- 50,-	013511	2190,- 92,-	013566
cyklindrické	Kč €	590,- 25,-	79977	880,- 37,-	013252	1910,- 80,-	013474	1910,- 80,-	031034	1180,- 50,-	013528	2190,- 92,-	013573
WC	Kč €	1020,- 43,-	79984	1320,- 55,-	013269	2490,- 104,-	013481	2490,- 104,-	031041	1620,- 68,-	013535	2780,- 116,-	013580
koule / klika R	Kč €	1320,- 55,-	79991	1620,- 68,-	013443	2780,- 116,-	013498	2780,- 116,-	031058	1910,- 80,-	013542	3070,- 128,-	013597
koule / klika L	Kč €	1320,- 55,-	80003	1620,- 68,-	013450	2780,- 116,-	013504	2780,- 116,-	031065	1910,- 80,-	013559	3070,- 128,-	013603
dozické	Kč €	730,- 31,-	012545	1020,- 43,-	013610	2050,- 86,-	013665	2050,- 86,-	031072	1320,- 55,-	013719	2350,- 98,-	013764
cyklindrické	Kč €	730,- 31,-	012552	1020,- 43,-	013627	2050,- 86,-	013672	2050,- 86,-	031089	1320,- 55,-	013726	2350,- 98,-	013771
WC	Kč €	1180,- 50,-	012569	1460,- 61,-	013634	2640,- 110,-	013689	2640,- 110,-	031096	1750,- 73,-	013733	2930,- 123,-	013788
koule / klika R	Kč €	1460,- 61,-	012576	1750,- 73,-	013641	2930,- 123,-	013696	2930,- 123,-	031102	2050,- 86,-	013740	3220,- 135,-	013795
koule / klika L	Kč €	1460,- 61,-	012583	1750,- 73,-	013658	2930,- 123,-	013702	2930,- 123,-	031119	2050,- 86,-	013757	3220,- 135,-	013801
dozické	Kč €	730,- 31,-	79915	1020,- 43,-	013818	1320,- 55,-	013863	1320,- 55,-	031126	1320,- 55,-	013917	2350,- 98,-	013962
cyklindrické	Kč €	730,- 31,-	79922	1020,- 43,-	013825	1320,- 55,-	013870	1320,- 55,-	031133	1320,- 55,-	013924	2350,- 98,-	013979
WC	Kč €	1180,- 50,-	79939	1460,- 61,-	013832	2050,- 86,-	013887	2050,- 86,-	031140	1750,- 73,-	013931	2930,- 123,-	013986
koule / klika R	Kč €	1460,- 61,-	79946	1750,- 73,-	013849	2930,- 123,-	013894	2930,- 123,-	031157	2050,- 86,-	013948	3220,- 135,-	013993
koule / klika L	Kč €	1460,- 61,-	79953	1750,- 73,-	013856	2930,- 123,-	013900	2930,- 123,-	031164	2050,- 86,-	013955	3220,- 135,-	014006
dozické	Kč €	880,- 37,-	012590	1180,- 50,-	014013	1460,- 61,-	014068	1460,- 61,-	031171	1460,- 61,-	014112	2490,- 104,-	014167
cyklindrické	Kč €	880,- 37,-	012606	1180,- 50,-	014020	1460,- 61,-	014075	1460,- 61,-	031188	1460,- 61,-	014129	2490,- 104,-	014174
WC	Kč €	1320,- 55,-	012613	1620,- 68,-	014037	2190,- 92,-	014082	2190,- 92,-	031195	1910,- 80,-	014136	3070,- 128,-	014181
koule / klika R	Kč €	1620,- 68,-	012620	1910,- 80,-	014044	3070,- 128,-	014099	3070,- 128,-	031201	2190,- 92,-	014143	3380,- 141,-	014198
koule / klika L	Kč €	1620,- 68,-	012637	1910,- 80,-	014051	3070,- 128,-	014105	3070,- 128,-	031218	2190,- 92,-	014150	3380,- 141,-	014204
dozické	Kč €	1180,- 50,-	012644	1460,- 61,-	014211	2490,- 104,-	014266	2490,- 104,-	031225	1750,- 73,-	014310	2780,- 116,-	014365
cyklindrické	Kč €	1180,- 50,-	012651	1460,- 61,-	014228	2490,- 104,-	014273	2490,- 104,-	031232	1750,- 73,-	014327	2780,- 116,-	014372
WC	Kč €	1620,- 68,-	012668	1910,- 80,-	014235	3070,- 128,-	014280	3070,- 128,-	031249	2190,- 92,-	014334	3380,- 141,-	014389
koule / klika R	Kč €	1910,- 80,-	012675	2190,- 92,-	014242	3380,- 141,-	014297	3380,- 141,-	031256	2490,- 104,-	014341	3660,- 153,-	014396
koule / klika L	Kč €	1910,- 80,-	012682	2190,- 92,-	014259	3380,- 141,-	014303	3380,- 141,-	031263	2490,- 104,-	014358	3660,- 153,-	014402

U kombinace koule / klika dodáváme standardně kouli Maty pevnou - neočnou. Na základě požadavku kouli Maty vyosenou pevnou - neočnou s příplatkem 140,- Kč z Maloobchodního ceníku. V balení je standardně montážní materiál pro tl. dveří 38 - 45 mm. Pro větší tloušťky dveří je potřeba specifikovat jiný montážní materiál viz. Příslušenství a komponenty str. 376. U řady kování Objekt a Projekt tř. 4 jsou spodní rozety standardně s pouzdrý pro rychlou a přesnou montáž.



NRz nerez - broušeno

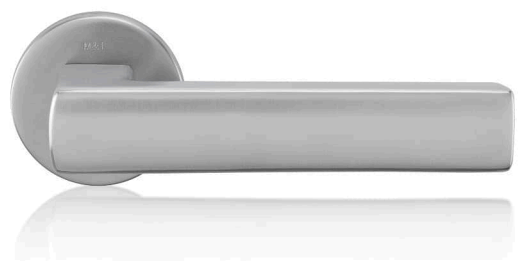
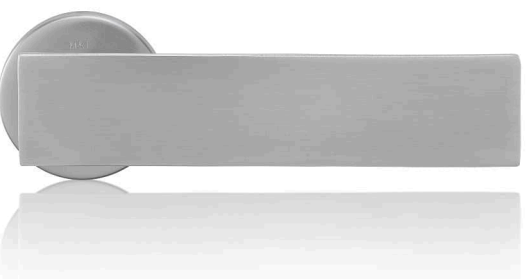

**Senza**

1180,- Kč  
50,- EUR

**Promo**

1320,- Kč  
55,- EUR

**Entero**

1620,- Kč  
68,- EUR

**Kvadra**

1320,- Kč  
55,- EUR

**Techno**

1180,- Kč  
50,- EUR

**Cesan**

1020,- Kč  
43,- EUR

**Economy nerez**

materiál: nerezová ocel

Kč povrch: NRz nerez - broušeno EUR

1180,- 50,-

1180,- 50,-

1620,- 68,-

1910,- 80,-

1910,- 80,-

1320,- 55,-

1320,- 55,-

1750,- 73,-

2050,- 86,-

2050,- 86,-

**Objekt nerez**

1620,- 68,-

1620,- 68,-

2050,- 86,-

2350,- 98,-

2350,- 98,-

1320,- 55,-

1320,- 55,-

1750,- 73,-

2050,- 86,-

2050,- 86,-

1180,- 50,-

1180,- 50,-

1620,- 68,-

1910,- 80,-

1910,- 80,-

1020,- 43,-

1020,- 43,-

1460,- 61,-

1750,- 73,-

1750,- 73,-

300,- 13,-

Provedení panikové pro zámky s děleným čtyřhranem je s příplatkem 200,- Kč (EAN 101416) k ceně cylindrického provedení. Dělený čtyřhran se objednává zvlášť a je třeba specifikovat přesnou délku čtyřhranu, str. 376. Kliku Kvadra a Promo nelze dodat v panikovém provedení.

		Economy nerez		Objekt nerez		Objekt titan		Objekt		Projekt tř. 4, (i protipožární)		Projekt tř. 4, (i protipožární)	
		NRz		NRz		TiN-K		K-industrial		NRz		TiN-K	
		cena / pár	EAN	cena / pár	EAN	cena / pár	EAN	cena / pár	EAN	cena / pár	EAN	cena / pár	EAN
dozické	Kč €	1180,- 50,-	012699	1460,- 61,-	014419			2130,- 89,-	031270	1750,- 73,-	014518		
cylinrické	Kč €	1180,- 50,-	012705	1460,- 61,-	014426			2130,- 89,-	031287	1750,- 73,-	014525		
WC	Kč €	1620,- 68,-	012712	1910,- 80,-	014433			2640,- 110,-	031294	2190,- 92,-	014532		
koule / klika R	Kč €	1910,- 80,-	012729	2190,- 92,-	014440			2880,- 120,-	031300	2490,- 104,-	014549		
koule / klika L	Kč €	1910,- 80,-	012736	2190,- 92,-	014457			2880,- 120,-	031317	2490,- 104,-	014556		
dozické	Kč €	1320,- 55,-	012743	1620,- 68,-	014617			2260,- 95,-	031324	1910,- 80,-	014716		
cylinrické	Kč €	1320,- 55,-	012750	1620,- 68,-	014624			2260,- 95,-	031331	1910,- 80,-	014723		
WC	Kč €	1750,- 73,-	012767	2050,- 86,-	014631			2760,- 115,-	031348	2350,- 98,-	014730		
koule / klika R	Kč €	2050,- 86,-	012774	2350,- 98,-	014648			3010,- 126,-	031355	2640,- 110,-	014747		
koule / klika L	Kč €	2050,- 86,-	012781	2350,- 98,-	014655			3010,- 126,-	031362	2640,- 110,-	014754		
dozické	Kč €			1620,- 68,-	79816	2640,- 110,-	014815	2640,- 110,-	138306	1910,- 80,-	014860	2930,- 123,-	014914
cylinrické	Kč €			1620,- 68,-	79823	2640,- 110,-	014822	2640,- 110,-	138313	1910,- 80,-	014877	2930,- 123,-	014921
WC	Kč €			2050,- 86,-	79830	3220,- 135,-	014839	3220,- 135,-	138320	2350,- 98,-	014884	3510,- 147,-	014938
koule / klika R	Kč €			2350,- 98,-	79847	3510,- 147,-	014846	3510,- 147,-	138337	2640,- 110,-	014891	3810,- 159,-	014945
koule / klika L	Kč €			2350,- 98,-	79854	3510,- 147,-	014853	3510,- 147,-	138344	2640,- 110,-	014907	3810,- 159,-	014952
dozické	Kč €	1320,- 55,-	012798	1620,- 68,-	014969	2640,- 110,-	015010	2640,- 110,-	031379	1910,- 80,-	015065	2930,- 123,-	015119
cylinrické	Kč €	1320,- 55,-	012804	1620,- 68,-	014976	2640,- 110,-	015027	2640,- 110,-	031386	1910,- 80,-	015072	2930,- 123,-	015126
WC	Kč €	1750,- 73,-	012811	2050,- 86,-	014983	3220,- 135,-	015034	3220,- 135,-	031393	2350,- 98,-	015089	3510,- 147,-	015133
koule / klika R	Kč €	2050,- 86,-	012828	2350,- 98,-	014990	3510,- 147,-	015041	3510,- 147,-	031409	2640,- 110,-	015096	3810,- 159,-	015140
koule / klika L	Kč €	2050,- 86,-	012835	2350,- 98,-	015003	3510,- 147,-	015058	3510,- 147,-	031416	2640,- 110,-	015102	3810,- 159,-	015157
dozické	Kč €	1180,- 50,-	012842	1460,- 61,-	015164			2130,- 89,-	031423	1750,- 73,-	015263		
cylinrické	Kč €	1180,- 50,-	012859	1460,- 61,-	015171			2130,- 89,-	031430	1750,- 73,-	015270		
WC	Kč €	1620,- 68,-	012866	1910,- 80,-	015188			2640,- 110,-	031447	2190,- 92,-	015287		
koule / klika R	Kč €	1910,- 80,-	012873	2190,- 92,-	015195			2880,- 120,-	031454	2490,- 104,-	015294		
koule / klika L	Kč €	1910,- 80,-	012880	2190,- 92,-	015201			2880,- 120,-	031461	2490,- 104,-	015300		
dozické	Kč €	1020,- 43,-	023398	1320,- 55,-	023442	2350,- 98,-	023497	2350,- 98,-	031478	1620,- 68,-	023541	2640,- 110,-	023596
cylinrické	Kč €	1020,- 43,-	023404	1320,- 55,-	023459	2350,- 98,-	023503	2350,- 98,-	031485	1620,- 68,-	023558	2640,- 110,-	023602
WC	Kč €	1460,- 61,-	023411	1750,- 73,-	023466	2930,- 123,-	023510	2930,- 123,-	031492	2050,- 86,-	023565	3220,- 135,-	023619
koule / klika R	Kč €	1750,- 73,-	023428	2050,- 86,-	023473	3220,- 135,-	023527	3220,- 135,-	031508	2350,- 98,-	023572	3510,- 147,-	023626
koule / klika L	Kč €	1750,- 73,-	023435	2050,- 86,-	023480	3220,- 135,-	023534	3220,- 135,-	031515	2350,- 98,-	023589	3510,- 147,-	023633
rozeta zaslepovací	Kč €	300,- 13,-	024135			590,- 25,-	024142	590,- 25,-	031522	Veškeré ceny v ceníku jsou bez DPH.			



TiN-K titan černý mat

**Lusy**

730,- Kč  
31,- EUR



NRz nerez - broušeno

**Deny**

730,- Kč  
31,- EUR



**Meclis**

1020,- Kč  
43,- EUR



**Morgan**

1020,- Kč  
43,- EUR



**Jameson**

1180,- Kč  
50,- EUR



**Nova**

1460,- Kč  
61,- EUR

**Economy nerez**

materiál: nerezová ocel

Kč povrch: NRz nerez - broušeno EUR

Kč			EUR
730,-			31,-
730,-			31,-
1260,-			53,-
1620,-			68,-
1620,-			68,-
730,-			31,-
730,-			31,-
1260,-			53,-
1620,-			68,-
1620,-			68,-
1020,-			43,-
1020,-			43,-
1550,-			65,-
1910,-			80,-
1910,-			80,-
1020,-			43,-
1020,-			43,-
1550,-			65,-
1910,-			80,-
1910,-			80,-
1180,-			50,-
1180,-			50,-
1710,-			72,-
2050,-			86,-
2050,-			86,-
1460,-			61,-
1460,-			61,-
1990,-			83,-
2350,-			98,-
2350,-			98,-

Provedení panikové pro zámky s děleným čtyřhranem je s příplatkem 200,- Kč (EAN 101416) k ceně cylindrického provedení. Dělený čtyřhran se objednává zvlášť a je třeba specifikovat přesnou délku čtyřhranu, str. 377.

		Economy nerez		Objekt nerez		Objekt titan		Objekt		Projekt tř. 4, (i protipožární)		Projekt tř. 4, (i protipožární)	
		NRz		NRz		TiN-K		K-industrial		NRz		TiN-K	
		cena / pár	EAN	cena / pár	EAN	cena / pár	EAN	cena / pár	EAN	cena / pár	EAN	cena / pár	EAN
dozické	Kč €	730,- 31,-	79663	1020,- 43,-	39131	1320,- 55,-	015386	1320,- 55,-	031539	1320,- 55,-	015430	2350,- 98,-	015485
cylinrické	Kč €	730,- 31,-	79670	1020,- 43,-	39148	1320,- 55,-	015393	1320,- 55,-	031546	1320,- 55,-	015447	2350,- 98,-	015492
WC	Kč €	1260,- 53,-	79687	1550,- 65,-	39155	2190,- 92,-	015409	2190,- 92,-	031553	1850,- 78,-	015454	3020,- 126,-	015508
madlo / klika R	Kč €	1620,- 68,-	79694	1910,- 80,-	015362	3070,- 128,-	015416	3070,- 128,-	031560	2190,- 92,-	015461	3380,- 141,-	015515
madlo / klika L	Kč €	1620,- 68,-	79700	1910,- 80,-	015379	3070,- 128,-	015423	3070,- 128,-	031577	2190,- 92,-	015478	3380,- 141,-	015522
dozické	Kč €	730,- 31,-	79762	1020,- 43,-	015539	2050,- 86,-	015584	2050,- 86,-	031584	1320,- 55,-	015638	2350,- 98,-	015683
cylinrické	Kč €	730,- 31,-	79779	1020,- 43,-	015546	2050,- 86,-	015591	2050,- 86,-	031591	1320,- 55,-	015645	2350,- 98,-	015690
WC	Kč €	1260,- 53,-	79786	1550,- 65,-	015553	2740,- 115,-	015607	2740,- 115,-	031607	1850,- 78,-	015652	3020,- 126,-	015706
madlo / klika R	Kč €	1620,- 68,-	79793	1910,- 80,-	015560	3070,- 128,-	015614	3070,- 128,-	031614	2190,- 92,-	015669	3380,- 141,-	015713
madlo / klika L	Kč €	1620,- 68,-	79809	1910,- 80,-	015577	3070,- 128,-	015621	3070,- 128,-	031621	2190,- 92,-	015676	3380,- 141,-	015720
dozické	Kč €	1020,- 43,-	012897	1320,- 55,-	015737	2350,- 98,-	015782	2350,- 98,-	031638	1620,- 68,-	015836	2640,- 110,-	015881
cylinrické	Kč €	1020,- 43,-	012903	1320,- 55,-	015744	2350,- 98,-	015799	2350,- 98,-	031645	1620,- 68,-	015843	2640,- 110,-	015898
WC	Kč €	1550,- 65,-	012910	1850,- 78,-	015751	3020,- 126,-	015805	3020,- 126,-	031652	2140,- 90,-	015850	3310,- 138,-	015904
madlo / klika R	Kč €	1910,- 80,-	012927	2190,- 92,-	015768	3380,- 141,-	015812	3380,- 141,-	031669	2490,- 104,-	015867	3660,- 153,-	015911
madlo / klika L	Kč €	1910,- 80,-	012934	2190,- 92,-	015775	3380,- 141,-	015829	3380,- 141,-	031676	2490,- 104,-	015874	3660,- 153,-	015928
dozické	Kč €	1020,- 43,-	79717	1320,- 55,-	39162	1460,- 61,-	015959	1460,- 61,-	031683	1620,- 68,-	016000	2640,- 110,-	016055
cylinrické	Kč €	1020,- 43,-	79724	1320,- 55,-	39179	1460,- 61,-	015966	1460,- 61,-	031690	1620,- 68,-	016017	2640,- 110,-	016062
WC	Kč €	1550,- 65,-	79731	1850,- 78,-	39186	2350,- 98,-	015973	2350,- 98,-	031706	2140,- 90,-	016024	3310,- 138,-	016079
madlo / klika R	Kč €	1910,- 80,-	79748	2190,- 92,-	015935	3380,- 141,-	015980	3380,- 141,-	031713	2490,- 104,-	016031	3660,- 153,-	016086
madlo / klika L	Kč €	1910,- 80,-	79755	2190,- 92,-	015942	3380,- 141,-	015997	3380,- 141,-	031720	2490,- 104,-	016048	3660,- 153,-	016093
dozické	Kč €	1180,- 50,-	012941	1460,- 61,-	016109	1620,- 68,-	016154	1620,- 68,-	031737	1750,- 73,-	016208	2780,- 116,-	016253
cylinrické	Kč €	1180,- 50,-	012958	1460,- 61,-	016116	1620,- 68,-	016161	1620,- 68,-	031744	1750,- 73,-	016215	2780,- 116,-	016260
WC	Kč €	1710,- 72,-	012965	1990,- 83,-	016123	2490,- 104,-	016178	2490,- 104,-	031751	2290,- 96,-	016222	3450,- 144,-	016277
madlo / klika R	Kč €	2050,- 86,-	012972	2350,- 98,-	016130	3510,- 147,-	016185	3510,- 147,-	031768	2640,- 110,-	016239	3810,- 159,-	016284
madlo / klika L	Kč €	2050,- 86,-	012989	2350,- 98,-	016147	3510,- 147,-	016192	3510,- 147,-	031775	2640,- 110,-	016246	3810,- 159,-	016291
dozické	Kč €	1460,- 61,-	012996	1750,- 73,-	016307	2780,- 116,-	016352	2780,- 116,-	031782	2050,- 86,-	016406	3070,- 128,-	016451
cylinrické	Kč €	1460,- 61,-	013009	1750,- 73,-	016314	2780,- 116,-	016369	2780,- 116,-	031799	2050,- 86,-	016413	3070,- 128,-	016468
WC	Kč €	1990,- 83,-	013016	2290,- 96,-	016321	3450,- 144,-	016376	3450,- 144,-	031805	2580,- 108,-	016420	3750,- 157,-	016475
madlo / klika R	Kč €	2350,- 98,-	013023	2640,- 110,-	016338	3810,- 159,-	016383	3810,- 159,-	031812	2930,- 123,-	016437	4100,- 171,-	016482
madlo / klika L	Kč €	2350,- 98,-	013030	2640,- 110,-	016345	3810,- 159,-	016390	3810,- 159,-	031829	2930,- 123,-	016444	4100,- 171,-	016499

U kombinace madlo / klika dodáváme standardně madlo Entero pevné - neotočné.

V balení je standardně montážní materiál pro tl. dveří 38 - 45 mm. Pro větší tloušťky dveří je potřeba specifikovat jiný montážní materiál viz. Příslušenství a komponenty str. 376.

U řady kování Objekt a Projekt tř. 4 jsou spodní rozety standardně s pouzdry pro rychlou a přesnou montáž.



NRz nerez - broušeno

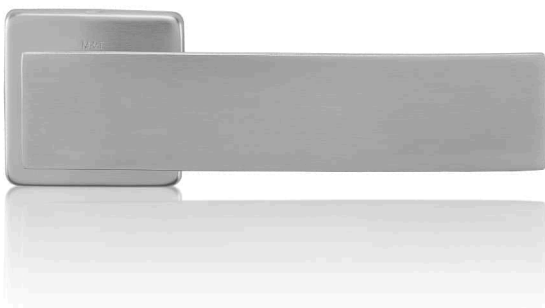

**Senza**

1320,- Kč  
55,- EUR

**Promo**

1460,- Kč  
61,- EUR

**Entero**

1750,- Kč  
73,- EUR

**Kvadra**

1460,- Kč  
61,- EUR

**Techno**

1460,- Kč  
61,- EUR

**Cesan**

1320,- Kč  
55,- EUR

**Economy nerez**

materiál: nerezová ocel

Kč povrch: NRz nerez - broušeno EUR

1320,-				55,-
1320,-				55,-
1850,-				78,-
2190,-				92,-
2190,-				92,-
<hr/>				
1460,-				61,-
1460,-				61,-
1990,-				83,-
2350,-				98,-
2350,-				98,-
<hr/>				
<b>Objekt nerez</b>				
1750,-				73,-
1750,-				73,-
2290,-				96,-
2640,-				110,-
2640,-				110,-
<hr/>				
1460,-				61,-
1460,-				61,-
1990,-				83,-
2350,-				98,-
2350,-				98,-
<hr/>				
1460,-				61,-
1460,-				61,-
1990,-				83,-
2350,-				98,-
2350,-				98,-
<hr/>				
1320,-				55,-
1320,-				55,-
1850,-				78,-
2190,-				92,-
2190,-				92,-
370,-				16,-

Provedení panikové pro zámky s děleným čtyřhranem je s příplatkem 200,- Kč (EAN 101416) k ceně cylindrického provedení. Dělený čtyřhran se objednává zvlášť a je třeba specifikovat přesnou délku čtyřhranu, str. 376. Kliku Kvadra a Promo nelze dodat v panikovém provedení.

		Economy nerez		Objekt nerez		Objekt titan		Objekt		Projekt tř. 4, (i protipožární)		Projekt tř. 4, (i protipožární)	
		NRz		NRz		TiN-K		K-industrial		NRz		TiN-K	
		cena / pár	EAN	cena / pár	EAN	cena / pár	EAN	cena / pár	EAN	cena / pár	EAN	cena / pár	EAN
dozické	Kč €	1320,- 55,-	013047	1620,- 68,-	016505			2640,- 110,-	031836	1910,- 80,-	016604		
cyldrické	Kč €	1320,- 55,-	013054	1620,- 68,-	016512			2640,- 110,-	031843	1910,- 80,-	016611		
WC	Kč €	1850,- 78,-	013061	2140,- 90,-	016529			3130,- 131,-	031850	2440,- 102,-	016628		
madlo / klika R	Kč €	2190,- 92,-	013078	2490,- 104,-	016536			3390,- 142,-	031867	2780,- 116,-	016635		
madlo / klika L	Kč €	2190,- 92,-	013085	2490,- 104,-	016543			3390,- 142,-	031874	2780,- 116,-	016642		
dozické	Kč €	1460,- 61,-	013092	1750,- 73,-	016703			2780,- 116,-	031881	2050,- 86,-	016802		
cyldrické	Kč €	1460,- 61,-	013108	1750,- 73,-	016710			2780,- 116,-	031898	2050,- 86,-	016819		
WC	Kč €	1990,- 83,-	013115	2290,- 96,-	016727			3450,- 144,-	031904	2580,- 108,-	016826		
madlo / klika R	Kč €	2350,- 98,-	013122	2640,- 110,-	016734			3810,- 159,-	031911	2930,- 123,-	016833		
madlo / klika L	Kč €	2350,- 98,-	013139	2640,- 110,-	016741			3810,- 159,-	031928	2930,- 123,-	016840		
dozické	Kč €			1750,- 73,-	79618	2780,- 116,-	016901	2780,- 116,-	138252	2050,- 86,-	016956	3070,- 128,-	017007
cyldrické	Kč €			1750,- 73,-	79625	2780,- 116,-	016918	2780,- 116,-	138269	2050,- 86,-	016963	3070,- 128,-	017014
WC	Kč €			2290,- 96,-	79632	3450,- 144,-	016925	3450,- 144,-	138276	2580,- 108,-	016970	3750,- 157,-	017021
madlo / klika R	Kč €			2640,- 110,-	79649	3810,- 159,-	016932	3810,- 159,-	138283	2930,- 123,-	016987	4100,- 171,-	017038
madlo / klika L	Kč €			2640,- 110,-	79656	3810,- 159,-	016949	3810,- 159,-	138290	2930,- 123,-	016994	4100,- 171,-	017045
dozické	Kč €	1460,- 61,-	013146	1750,- 73,-	017052	2780,- 116,-	017106	2780,- 116,-	031935	2050,- 86,-	017151	3070,- 128,-	017205
cyldrické	Kč €	1460,- 61,-	013153	1750,- 73,-	017069	2780,- 116,-	017113	2780,- 116,-	031942	2050,- 86,-	017168	3070,- 128,-	017212
WC	Kč €	1990,- 83,-	013160	2290,- 96,-	017076	3450,- 144,-	017120	3450,- 144,-	031959	2580,- 108,-	017175	3750,- 157,-	017229
madlo / klika R	Kč €	2350,- 98,-	013177	2640,- 110,-	017083	3810,- 159,-	017137	3810,- 159,-	031966	2930,- 123,-	017182	4100,- 171,-	017236
madlo / klika L	Kč €	2350,- 98,-	013184	2640,- 110,-	017090	3810,- 159,-	017144	3810,- 159,-	031973	2930,- 123,-	017199	4100,- 171,-	017243
dozické	Kč €	1460,- 61,-	013191	1750,- 73,-	017250			2780,- 116,-	031980	2050,- 86,-	017359		
cyldrické	Kč €	1460,- 61,-	013207	1750,- 73,-	017267			2780,- 116,-	031997	2050,- 86,-	017366		
WC	Kč €	1990,- 83,-	013214	2290,- 96,-	017274			3450,- 144,-	032000	2580,- 108,-	017373		
madlo / klika R	Kč €	2350,- 98,-	013221	2640,- 110,-	017281			3810,- 159,-	032017	2930,- 123,-	017380		
madlo / klika L	Kč €	2350,- 98,-	013238	2640,- 110,-	017298			3810,- 159,-	032024	2930,- 123,-	017397		
dozické	Kč €	1320,- 55,-	023640	1620,- 68,-	023695	2640,- 110,-	023749	2640,- 110,-	032031	1910,- 80,-	023794	2930,- 123,-	023848
cyldrické	Kč €	1320,- 55,-	023657	1620,- 68,-	023701	2640,- 110,-	023756	2640,- 110,-	032048	1910,- 80,-	023800	2930,- 123,-	023855
WC	Kč €	1850,- 78,-	023664	2140,- 90,-	023718	3310,- 138,-	023763	3310,- 138,-	032055	2440,- 102,-	023817	3610,- 151,-	023862
madlo / klika R	Kč €	2190,- 92,-	023671	2490,- 104,-	023725	3660,- 153,-	023770	3660,- 153,-	032062	2780,- 116,-	023824	3950,- 165,-	023879
madlo / klika L	Kč €	2190,- 92,-	023688	2490,- 104,-	023732	3660,- 153,-	023787	3660,- 153,-	032079	2780,- 116,-	023831	3950,- 165,-	023886
rozeta zaslepovací	Kč €	370,- 16,-	024159			730,- 31,-	024166	730,- 31,-	032086				



NRz nerez - broušeno

**Hanna**

1180,- Kč  
50,- EUR

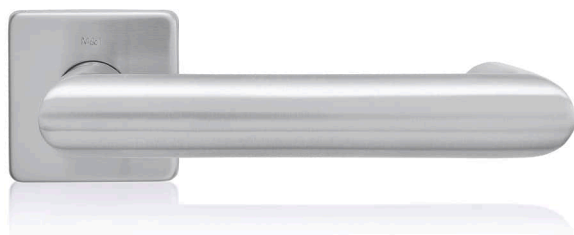

**Hanna**

1460,- Kč  
61,- EUR



**Sonia**

1020,- Kč  
43,- EUR



**Sonia**

1320,- Kč  
55,- EUR

**Economy nerez**  
materiál: nerezová ocel  
povrch: NRz nerez - broušeno

Kč		EUR
1180,-		50,-
1180,-		50,-
1620,-		68,-
1910,-		80,-
1910,-		80,-
<hr/>		
1460,-		61,-
1460,-		61,-
1990,-		83,-
2350,-		98,-
2350,-		98,-

**Economy nerez**  
materiál: nerezová ocel  
povrch: NRz nerez - broušeno

Kč		EUR
1020,-		43,-
1020,-		43,-
1460,-		61,-
1750,-		73,-
1750,-		73,-
<hr/>		
1320,-		55,-
1320,-		55,-
1850,-		78,-
2190,-		92,-
2190,-		92,-



		Economy nerez		Objekt nerez		Objekt titan		Objekt		Projekt tř. 4, (i protipožární)		Projekt tř. 4, (i protipožární)	
		NRz		NRz		TiN-K		K-industrial		NRz		TiN-K	
		cena / pár	EAN	cena / pár	EAN	cena / pár	EAN	cena / pár	EAN	cena / pár	EAN	cena / pár	EAN
dozické	Kč €	1180,- 50,-	046762	1460,- 61,-	046892	2490,- 104,-	104769	2490,- 104,-	138351	1750,- 73,-	081800	2780,- 116,-	104813
cyklindrické	Kč €	1180,- 50,-	046779	1460,- 61,-	046908	2490,- 104,-	104776	2490,- 104,-	138368	1750,- 73,-	081817	2780,- 116,-	104820
WC	Kč €	1620,- 68,-	046786	1910,- 80,-	046915	3070,- 128,-	104783	3070,- 128,-	138375	2190,- 92,-	081824	3380,- 141,-	104837
koule / klika R	Kč €	1910,- 80,-	046793	2190,- 92,-	046922	3380,- 141,-	104790	3380,- 141,-	138382	2490,- 104,-	081831	3660,- 153,-	104844
koule / klika L	Kč €	1910,- 80,-	046809	2190,- 92,-	046939	3380,- 141,-	104806	3380,- 141,-	138399	2490,- 104,-	081848	3660,- 153,-	104943
dozické	Kč €	1460,- 61,-	046816	1750,- 73,-	046946	2780,- 116,-	104950	2780,- 116,-	138405	2050,- 86,-	081855	3070,- 128,-	105001
cyklindrické	Kč €	1460,- 61,-	046823	1750,- 73,-	046953	2780,- 116,-	104967	2780,- 116,-	138412	2050,- 86,-	081862	3070,- 128,-	105018
WC	Kč €	1990,- 83,-	046830	2290,- 96,-	046960	3450,- 144,-	104974	3450,- 144,-	138429	2580,- 108,-	081879	3750,- 157,-	105025
madlo / klika R	Kč €	2350,- 98,-	046847	2640,- 110,-	046977	3810,- 159,-	104981	3810,- 159,-	138436	2930,- 123,-	081886	4100,- 171,-	082029
madlo / klika L	Kč €	2350,- 98,-	046854	2640,- 110,-	046984	3810,- 159,-	104998	3810,- 159,-	138443	2930,- 123,-	081893	4100,- 171,-	082036

U kombinace koule / klika dodáváme standardně kouli Maty pevnou - neotočnou. Na základě požadavku kouli Maty vyosenou pevnou - neotočnou s příplatkem 140,- Kč z Maloobchodního ceníku. V balení je standardně montážní materiál pro tl. dveří 38 - 45 mm. Pro větší tloušťky dveří je potřeba specifikovat jiný montážní materiál viz. Příslušenství a komponenty str. 376.  
U řady kování Objekt a Projekt tř. 4 jsou spodní rozety standardně s pouzdry pro rychlou a přesnou montáž.

		Economy nerez		Objekt nerez		Objekt titan		Objekt		Projekt tř. 4, (i protipožární)		Projekt tř. 4, (i protipožární)	
		NRz		NRz		TiN-K		K-industrial		NRz		TiN-K	
		cena / pár	EAN	cena / pár	EAN	cena / pár	EAN	cena / pár	EAN	cena / pár	EAN	cena / pár	EAN
dozické	Kč €	1020,- 43,-	102734	1320,- 55,-	102789	2350,- 98,-	102833	2350,- 98,-	138450	1620,- 68,-	102888	2640,- 110,-	102932
cyklindrické	Kč €	1020,- 43,-	102741	1320,- 55,-	102796	2350,- 98,-	102840	2350,- 98,-	138467	1620,- 68,-	102895	2640,- 110,-	102949
WC	Kč €	1460,- 61,-	102758	1750,- 73,-	102802	2930,- 123,-	102857	2930,- 123,-	138474	2050,- 86,-	102901	3220,- 135,-	102956
koule / klika R	Kč €	1750,- 73,-	102765	2050,- 86,-	102819	3220,- 135,-	102864	3220,- 135,-	138481	2350,- 98,-	102918	3510,- 147,-	102963
koule / klika L	Kč €	1750,- 73,-	102772	2050,- 86,-	102826	3220,- 135,-	102871	3220,- 135,-	138498	2350,- 98,-	102925	3510,- 147,-	102970
dozické	Kč €	1320,- 55,-	102987	1620,- 68,-	103038	2640,- 110,-	103083	2640,- 110,-	138504	1910,- 80,-	103137	2930,- 123,-	103182
cyklindrické	Kč €	1320,- 55,-	102994	1620,- 68,-	103045	2640,- 110,-	103090	2640,- 110,-	138511	1910,- 80,-	103144	2930,- 123,-	103199
WC	Kč €	1850,- 78,-	103007	2140,- 90,-	103052	3310,- 138,-	103106	3310,- 138,-	138528	2440,- 102,-	103151	3610,- 151,-	103205
madlo / klika R	Kč €	2190,- 92,-	103014	2490,- 104,-	103069	3660,- 153,-	103113	3660,- 153,-	138535	2780,- 116,-	103168	3950,- 165,-	103212
madlo / klika L	Kč €	2190,- 92,-	103021	2490,- 104,-	103076	3660,- 153,-	103120	3660,- 153,-	138542	2780,- 116,-	103175	3950,- 165,-	103229

U kombinace madlo / klika dodáváme standardně madlo Entero pevné - neotočné.  
V balení je standardně montážní materiál pro tl. dveří 38 - 45 mm. Pro větší tloušťky dveří je potřeba specifikovat jiný montážní materiál viz. Příslušenství a komponenty str. 376.  
U řady kování Objekt a Projekt tř. 4 jsou spodní rozety standardně s pouzdry pro rychlou a přesnou montáž.

# MAGNETICKÉ ROZETY

**SYSTÉM NEODYMY ULTRA MAGNET KONCEPT**  
rychlé, pevné, použitelné, inovativně dlouhodobě fluorenty  
pohledové rozety k zabíradlům/vnitřní rozetě

ČTVERCOVÁ 54 x 54 mm

KULATÁ Ø 54 mm



**SYSTÉM PROŠROUBOVÁNÍ  
BEZ MOŽNOSTI POTOČENÍ ROZET**  
přetné navrtávací vložky/pouzdra nasazené  
do předvrtaných otvorů ve dřevě, zbrnění  
pokřemíku pohybu celé konstrukce rozet

**SYSTÉM FIXACE ŠROUBU TUFLOX®**  
s odlehčeným nylonovým povlakem dlouhodobě  
garantuje stabilitu celé konstrukce bez možnosti  
samovolného uvolnění + nabízí další 4 fixační body  
pomocí samolepných vrutů

**SYSTÉM 1. SPRING**  
optimální síly stlačení na tlak je doplněno  
vratnou pružinou montážně připravenou  
pouze na jedné straně, dává funkčnosti  
zajišťuje otevření zámek

**SYSTÉM  
KLUZNYCH POUZDER**  
polymerová lužná pouzdra precizně vedou  
tlaky v rozetě a dlouhodobě zajišťují jejich tlaky  
a bezvadný chod

**SYSTÉM FIX M6**  
tlace tlak k ovládacímu číhřanu pomocí speciálně  
navořenému červku M6, kdy se celá dovedací plocha  
zařadí do připravené drážky. Zhyhřanu o tím zmenšují  
pokřemíku požadšímu nechtěnému uvolnění tlak.  
S červkem dodávaná zařizovací gel zabránění  
samovolnému uvolnění

Mechanika 2018  
**MAGNETIC system**

34 komponentů  
6 zásadních inovací  
1 dokonale celek

## Dveřní kliky Nerez + magnetické rozety

Materiál rozet: **magnetická nerez ocel**

Materiál klik: **nerezová ocel**

Povrchy: **NRz** nerez broušeno, **TiN-K** titan černý mat, **K-industrial** černý mat strukturovaný

Konstrukce, mechanika: **magnetické rozety s 1 vratnou pružinou, mechanika 2018**

Konstrukční varianty: **Objekt, Projekt tř. 4**

Nejdokonalejší a nejrychlejší systém montáže. Účinný systém, který dlouhodobě pevně fixuje kliky a MG rozety k dveřnímu křídlu bez možnosti jakéhokoliv pohybu rozet po dveřním křídle, bez možnosti poškrábání dveří. Tloušťka pouhých 5 mm předurčuje MG rozety ke kombinaci s projektovými, tak s designovými řadami dveřních klik. Konstrukce rozet umožňuje montáž klik ve variantě plochých/přisazených rozet nebo plně zapuštěných.

**NOVA TiN-K** titan černý mat



**PROMO NRz** nerez ocel broušeno

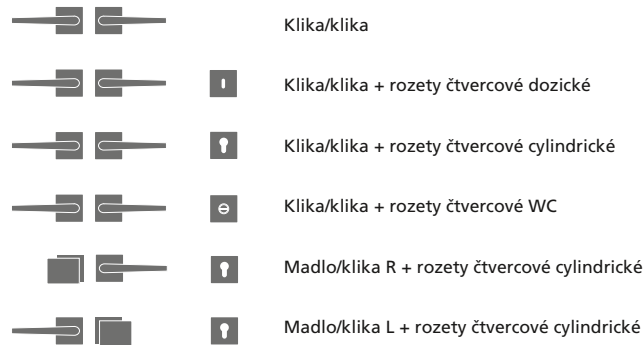

magnetické rozety Ø 54 mm, tl. 5 mm



koule Maty



magnetické rozety 54x54 mm, tl. 5 mm



madlo Entero

konstrukční varianty, materiálové provedení

- set kování s 1 vratnou pružinou
- sešroubování pouzdry proti sobě
- příprava do dveří: vrtání otvoru průměr 24 – 25mm
- MG rozety plně nahrazují ploché i zapuštěné rozety
- kliky s MG rozetami lze plně zapustit do dveří, pozor na zeslabenou stranu u falcových a reversních dveří. Prostor/hloubka zapuštění pro MG rozety včetně vratné pružiny a krčku kliky je 8,5 mm.
- provedení Projekt dodáváme automaticky ve variantě s protipožární úpravou, s nerezovým čtyřhranem
- zajišťovací gel proti uvolňování červíků
- vrtání PROFI šablonou M&T vrtákem Ø 6,4 mm
- montáž pro tloušťky dveří 38 – 126 mm
- v balení standardně montážní materiál pro tl. dveří 38 - 45 mm
- záruka 5 let povrch NRz, titan 15 let
- záruka mechanika 5 let provedení Objekt, 7 let provedení Projekt tř. 4

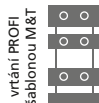

let **5 garance**    let **7 garance**

Ochranná známka – registrovaná značka

**ENTERO®**



Chráněné průmyslové vzory klik



**MORGAN  
ENTERO  
SENZA  
PROMO  
NOVA  
KVADRA**



NRz nerez - broušeno

**Lusy**

870,- Kč  
37,- EUR

Kč	materiál: nerezová ocel povrch: NRz nerez - broušeno	EUR
870,-		37,-
1390,-		58,-
1390,-		58,-
1850,-		78,-
2080,-		87,-
2080,-		87,-



TiN-K titan černý mat



**Deny**

1010,- Kč  
43,- EUR

Kč	materiál: nerezová ocel povrch: NRz nerez - broušeno	EUR
1010,-		43,-
1530,-		64,-
1530,-		64,-
1990,-		83,-
2270,-		95,-
2270,-		95,-



		Magnetická rozeta									
		Objekt						Projekt tř. 4 (i protipožární)			
		NRz		TiN-K		K-industrial		NRz		TiN-K	
		cena / pár	EAN	cena / pár	EAN	cena / pár	EAN	cena / pár	EAN	cena / pár	EAN
klika / klika	Kč €	870,- 37,-	089653	1660,- 70,-	089714	1660,- 70,-	138573	1260,- 53,-	115420	2190,- 92,-	115482
dozické	Kč €	1390,- 58,-	089660	2580,- 108,-	089721	2580,- 108,-	138580	1770,- 74,-	115437	3110,- 130,-	115499
cyklindrické	Kč €	1390,- 58,-	089677	2580,- 108,-	089738	2580,- 108,-	138597	1770,- 74,-	115444	3110,- 130,-	115505
WC	Kč €	1850,- 78,-	089684	3050,- 128,-	089745	3050,- 128,-	138603	2260,- 95,-	115451	3590,- 150,-	115512
koule / klika R	Kč €	2080,- 87,-	089691	3280,- 137,-	089752	3280,- 137,-	138610	2480,- 104,-	115468	3810,- 159,-	115529
koule / klika L	Kč €	2080,- 87,-	089707	3280,- 137,-	089769	3280,- 137,-	138627	2480,- 104,-	115475	3810,- 159,-	115536

		Magnetická rozeta									
		Objekt						Projekt tř. 4 (i protipožární)			
		NRz		TiN-K		K-industrial		NRz		TiN-K	
		cena / pár	EAN	cena / pár	EAN	cena / pár	EAN	cena / pár	EAN	cena / pár	EAN
klika / klika	Kč €	1010,- 43,-	089776	1820,- 76,-	089837	1820,- 76,-	138634	1420,- 60,-	115543	2350,- 98,-	115604
dozické	Kč €	1530,- 64,-	089783	2740,- 115,-	089844	2740,- 115,-	138641	1930,- 81,-	115550	3260,- 136,-	115611
cyklindrické	Kč €	1530,- 64,-	089790	2740,- 115,-	089851	2740,- 115,-	138658	1930,- 81,-	115567	3260,- 136,-	115628
WC	Kč €	1990,- 83,-	089806	3200,- 134,-	089868	3200,- 134,-	138665	2390,- 100,-	115574	3720,- 155,-	115635
koule / klika R	Kč €	2270,- 95,-	089813	3450,- 144,-	089875	3450,- 144,-	138672	2660,- 111,-	115581	3990,- 167,-	115642
koule / klika L	Kč €	2270,- 95,-	089820	3450,- 144,-	089882	3450,- 144,-	138689	2660,- 111,-	115598	3990,- 167,-	115659



NRz nerez - broušeno

**Meclis**

1170,- Kč  
49,- EUR

Kč	materiál: nerezová ocel povrch: NRz nerez - broušeno		EUR
1170,-			49,-
1670,-			70,-
1670,-			70,-
2140,-			90,-
2400,-			100,-
2400,-			100,-



TiN-K titan černý mat

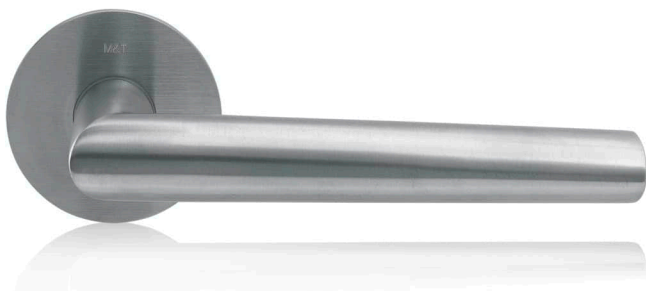

**Morgan**

1170,- Kč  
49,- EUR

Kč	materiál: nerezová ocel povrch: NRz nerez - broušeno		EUR
1170,-			49,-
1670,-			70,-
1670,-			70,-
2140,-			90,-
2400,-			100,-
2400,-			100,-



Kliky v kategorii Projekt se vyrábějí jako protipožární a dodávají se včetně protipožárního nerezového čtyřhranu. Pro případ požadavku panikové funkce je třeba objednat variantu z kategorie dveřní kličky NEREZ str. 30 – 41. Dále je třeba objednat dělený čtyřhran a specifikovat přesnou délku čtyřhranu str. 377. Magnetické rozety se s panikovou funkcí nedodávají.

	Magnetická rozeta										
	Objekt							Projekt tř. 4 (i protipožární)			
	NRz		TiN-K		K-industrial		NRz		TiN-K		
		cena / pár	EAN	cena / pár	EAN	cena / pár	EAN	cena / pár	EAN	cena / pár	EAN
klika / klika	Kč €	1170,- 49,-	089899	1950,- 82,-	089950	1950,- 82,-	138696	1550,- 65,-	115666	2490,- 104,-	115727
dozické	Kč €	1670,- 70,-	089905	2870,- 120,-	089967	2870,- 120,-	138702	2080,- 87,-	115673	3410,- 143,-	115734
cyklindrické	Kč €	1670,- 70,-	089912	2870,- 120,-	089974	2870,- 120,-	138719	2080,- 87,-	115680	3410,- 143,-	115741
WC	Kč €	2140,- 90,-	089929	3330,- 139,-	089981	3330,- 139,-	138726	2550,- 107,-	115697	3870,- 162,-	115758
koule / klika R	Kč €	2400,- 100,-	089936	3610,- 151,-	089998	3610,- 151,-	138733	2800,- 117,-	115703	4140,- 173,-	115765
koule / klika L	Kč €	2400,- 100,-	089943	3610,- 151,-	090000	3610,- 151,-	138740	2800,- 117,-	115710	4140,- 173,-	115772

	Magnetická rozeta										
	Objekt							Projekt tř. 4 (i protipožární)			
	NRz		TiN-K		K-industrial		NRz		TiN-K		
		cena / pár	EAN	cena / pár	EAN	cena / pár	EAN	cena / pár	EAN	cena / pár	EAN
klika / klika	Kč €	1170,- 49,-	090017	1950,- 82,-	090079	1950,- 82,-	138757	1550,- 65,-	115789	2490,- 104,-	115840
dozické	Kč €	1670,- 70,-	090024	2870,- 120,-	090086	2870,- 120,-	138764	2080,- 87,-	115796	3410,- 143,-	115857
cyklindrické	Kč €	1670,- 70,-	090031	2870,- 120,-	090093	2870,- 120,-	138771	2080,- 87,-	115802	3410,- 143,-	115864
WC	Kč €	2140,- 90,-	090048	3330,- 139,-	090109	3330,- 139,-	138788	2550,- 107,-	115819	3870,- 162,-	115871
koule / klika R	Kč €	2400,- 100,-	090055	3610,- 151,-	090116	3610,- 151,-	138795	2800,- 117,-	115826	4140,- 173,-	115888
koule / klika L	Kč €	2400,- 100,-	090062	3610,- 151,-	090123	3610,- 151,-	138801	2800,- 117,-	115833	4140,- 173,-	115895



NRz nerez - broušeno

**Jameson**

1300,- Kč  
55,- EUR

Kč	materiál: nerezová ocel povrch: NRz nerez - broušeno		EUR
1300,-			55,-
1830,-			77,-
1830,-			77,-
2290,-			96,-
2560,-			107,-
2560,-			107,-



TIN-K titan černý mat



**Nova**

1610,- Kč  
68,- EUR

Kč	materiál: nerezová ocel povrch: NRz nerez - broušeno		EUR
1610,-			68,-
2120,-			89,-
2120,-			89,-
2580,-			108,-
2850,-			119,-
2850,-			119,-



Kliky v kategorii Projekt se vyrábějí jako protipožární a dodávají se včetně protipožárního nerezového čtyřhranu. Pro případ požadavku panikové funkce je třeba objednat variantu z kategorie dveřní kličky NEREZ str. 30 – 41. Dále je třeba objednat dělený čtyřhran a specifikovat přesnou délku čtyřhranu str. 377. Magnetické rozety se s panikovou funkcí nedodávají.



	Magnetická rozeta										
	Objekt						Projekt tř. 4 (i protipožární)				
	NRz		TiN-K		K-industrial		NRz		TiN-K		
		cena / pár	EAN	cena / pár	EAN	cena / pár	EAN	cena / pár	EAN	cena / pár	EAN
klika / klika	Kč €	1300,- 55,-	090130	2110,- 88,-	090192	2110,- 88,-	138818	1710,- 72,-	115901	2640,- 110,-	115963
dozické	Kč €	1830,- 77,-	090147	3020,- 126,-	090208	3020,- 126,-	138825	2220,- 93,-	115918	3540,- 148,-	115970
cyindrické	Kč €	1830,- 77,-	090154	3020,- 126,-	090215	3020,- 126,-	138832	2220,- 93,-	115925	3540,- 148,-	115987
WC	Kč €	2290,- 96,-	090161	3490,- 146,-	090222	3490,- 146,-	138849	2690,- 113,-	115932	4030,- 168,-	115994
koule / klika R	Kč €	2560,- 107,-	090178	3750,- 157,-	090239	3750,- 157,-	138856	2960,- 124,-	115949	4280,- 179,-	116007
koule / klika L	Kč €	2560,- 107,-	090185	3750,- 157,-	090246	3750,- 157,-	138863	2960,- 124,-	115956	4280,- 179,-	116014

	Magnetická rozeta										
	Objekt						Projekt tř. 4 (i protipožární)				
	NRz		TiN-K		K-industrial		NRz		TiN-K		
		cena / pár	EAN	cena / pár	EAN	cena / pár	EAN	cena / pár	EAN	cena / pár	EAN
klika / klika	Kč €	1610,- 68,-	090253	2390,- 100,-	090314	2390,- 100,-	138870	1990,- 83,-	116021	2930,- 123,-	116083
dozické	Kč €	2120,- 89,-	090260	3310,- 138,-	090321	3310,- 138,-	138887	2510,- 105,-	116038	3850,- 161,-	116090
cyindrické	Kč €	2120,- 89,-	090277	3310,- 138,-	090338	3310,- 138,-	138894	2510,- 105,-	116045	3850,- 161,-	116106
WC	Kč €	2580,- 108,-	090284	3770,- 158,-	090345	3770,- 158,-	138900	2980,- 125,-	116052	4320,- 180,-	116113
koule / klika R	Kč €	2850,- 119,-	090291	4050,- 169,-	090352	4050,- 169,-	138917	3240,- 135,-	116069	4570,- 191,-	116120
koule / klika L	Kč €	2850,- 119,-	090307	4050,- 169,-	090369	4050,- 169,-	138924	3240,- 135,-	116076	4570,- 191,-	116137

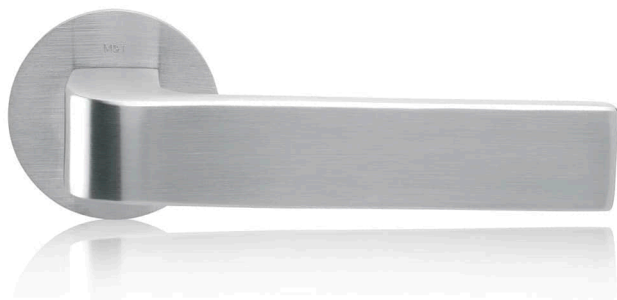

NRz nerez - broušeno

**Promo**

1740,- Kč  
73,- EUR

Kč	materiál: nerezová ocel povrch: NRz nerez - broušeno		EUR
1740,-			73,-
2270,-			95,-
2270,-			95,-
2740,-			115,-
3000,-			125,-
3000,-			125,-



**Senza**

1610,- Kč  
68,- EUR

Kč	materiál: nerezová ocel povrch: NRz nerez - broušeno		EUR
1610,-			68,-
2120,-			89,-
2120,-			89,-
2580,-			108,-
2850,-			119,-
2850,-			119,-

Kliky v kategorii Projekt se vyrábějí jako protipožární a dodávají se včetně protipožárního nerezového čtyřhranu. Pro případ požadavku panikové funkce je třeba objednat variantu z kategorie dveřní kličky NEREZ str. 30 – 41. Dále je třeba objednat dělený čtyřhran a specifikovat přesnou délku čtyřhranu str. 377. Magnetické rozety se s panikovou funkcí nedodávají.

	Magnetická rozeta										
	Objekt						Projekt tř. 4 (i protipožární)				
	NRz		TiN-K		K-industrial		NRz		TiN-K		
	cena / pár	EAN	cena / pár	EAN	cena / pár	EAN	cena / pár	EAN	cena / pár	EAN	
klika / klika	Kč €	1740,- 73,-	090499			2550,- 107,-	138931	2140,- 90,-	116205		
dozické	Kč €	2270,- 95,-	090505			3450,- 144,-	138948	2660,- 111,-	116212		
cyldrické	Kč €	2270,- 95,-	090512			3450,- 144,-	138955	2660,- 111,-	116229		
WC	Kč €	2740,- 115,-	090529			3920,- 164,-	138962	3130,- 131,-	116236		
koule / klika R	Kč €	3000,- 125,-	090536			4180,- 175,-	138979	3400,- 142,-	116243		
koule / klika L	Kč €	3000,- 125,-	090543			4180,- 175,-	138986	3400,- 142,-	116250		

	Magnetická rozeta										
	Objekt						Projekt tř. 4 (i protipožární)				
	NRz		TiN-K		K-industrial		NRz		TiN-K		
	cena / pár	EAN	cena / pár	EAN	cena / pár	EAN	cena / pár	EAN	cena / pár	EAN	
klika / klika	Kč €	1610,- 68,-	090376			2400,- 100,-	138993	1990,- 83,-	116144		
dozické	Kč €	2120,- 89,-	090383			3310,- 138,-	139006	2510,- 105,-	116151		
cyldrické	Kč €	2120,- 89,-	090390			3310,- 138,-	139013	2510,- 105,-	116168		
WC	Kč €	2580,- 108,-	090406			3770,- 158,-	139020	2980,- 125,-	116175		
koule / klika R	Kč €	2850,- 119,-	090413			4040,- 169,-	139037	3240,- 135,-	116182		
koule / klika L	Kč €	2850,- 119,-	090420			4040,- 169,-	139044	3240,- 135,-	116199		



NRz nerez - broušeno

**Kvadra**

1740,- Kč  
73,- EUR

Kč	materiál: nerezová ocel povrch: NRz nerez - broušeno		EUR
1740,-			73,-
2270,-			95,-
2270,-			95,-
2740,-			115,-
3000,-			125,-
3000,-			125,-



TiN-K titan černý mat



**Entero**

1740,- Kč  
73,- EUR

Kč	materiál: nerezová ocel povrch: NRz nerez - broušeno		EUR
1740,-			73,-
2270,-			95,-
2270,-			95,-
2740,-			115,-
3000,-			125,-
3000,-			125,-



Kliky v kategorii Projekt se vyrábějí jako protipožární a dodávají se včetně protipožárního nerezového čtyřhranu. Pro případ požadavku panikové funkce je třeba objednat variantu z kategorie dveřní kličky NEREZ str. 30 – 41. Dále je třeba objednat dělený čtyřhran a specifikovat přesnou délku čtyřhranu str. 377. Magnetické rozety se s panikovou funkcí nedodávají.

	Magnetická rozeta										
	Objekt							Projekt tř. 4 (i protipožární)			
	NRz		TiN-K		K-industrial		NRz		TiN-K		
	cena / pár	EAN	cena / pár	EAN	cena / pár	EAN	cena / pár	EAN	cena / pár	EAN	
klika / klika	Kč €	1740,- 73,-	090734	2550,- 107,-	090796	2550,- 107,-	139051	2140,- 90,-	116380	3070,- 128,-	116441
dozické	Kč €	2270,- 95,-	090741	3450,- 144,-	090802	3450,- 144,-	139068	2660,- 111,-	116397	3990,- 167,-	116458
cyindrické	Kč €	2270,- 95,-	090758	3450,- 144,-	090819	3450,- 144,-	139075	2660,- 111,-	116403	3990,- 167,-	116465
WC	Kč €	2740,- 115,-	090765	3920,- 164,-	090826	3920,- 164,-	139082	3130,- 131,-	116410	4460,- 186,-	116472
koule / klika R	Kč €	3000,- 125,-	090772	4180,- 175,-	090833	4180,- 175,-	139099	3400,- 142,-	116427	4730,- 198,-	116489
koule / klika L	Kč €	3000,- 125,-	090789	4180,- 175,-	090840	4180,- 175,-	139105	3400,- 142,-	116434	4730,- 198,-	116496

	Magnetická rozeta										
	Objekt							Projekt tř. 4 (i protipožární)			
	NRz		TiN-K		K-industrial		NRz		TiN-K		
	cena / pár	EAN	cena / pár	EAN	cena / pár	EAN	cena / pár	EAN	cena / pár	EAN	
klika / klika	Kč €	1740,- 73,-	090611	2550,- 107,-	090673	2550,- 107,-	139112	2140,- 90,-	116267	3070,- 128,-	116328
dozické	Kč €	2270,- 95,-	090628	3450,- 144,-	090680	3450,- 144,-	139129	2660,- 111,-	116274	3990,- 167,-	116335
cyindrické	Kč €	2270,- 95,-	090635	3450,- 144,-	090697	3450,- 144,-	139136	2660,- 111,-	116281	3990,- 167,-	116342
WC	Kč €	2740,- 115,-	090642	3920,- 164,-	090703	3920,- 164,-	139143	3130,- 131,-	116298	4460,- 186,-	116359
koule / klika R	Kč €	3000,- 125,-	090659	4180,- 175,-	090710	4180,- 175,-	139150	3400,- 142,-	116304	4730,- 198,-	116366
koule / klika L	Kč €	3000,- 125,-	090666	4180,- 175,-	090727	4180,- 175,-	139167	3400,- 142,-	116311	4730,- 198,-	116373



NRz nerez - broušeno

**Techno**

1610,- Kč  
68,- EUR

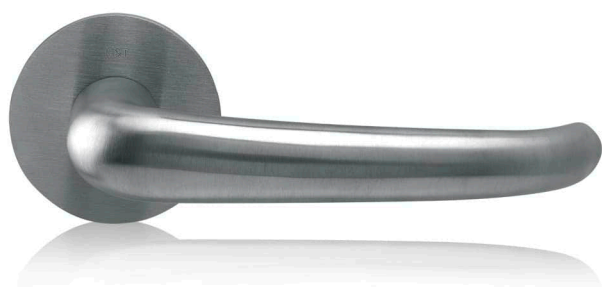

**Cesan**

1450,- Kč  
61,- EUR



TiN-K titan černý mat

materiál: nerezová ocel  
povrch: NRz nerez - broušeno

Kč			EUR
1610,-			68,-
2120,-			89,-
2120,-			89,-
2580,-			108,-
2850,-			119,-
2850,-			119,-

materiál: nerezová ocel  
povrch: NRz nerez - broušeno

Kč			EUR
1450,-			61,-
1960,-			82,-
1960,-			82,-
2440,-			102,-
2700,-			113,-
2700,-			113,-

	Magnetická rozeta										
	Objekt						Projekt tř. 4 (i protipožární)				
	NRz		TiN-K		K-industrial		NRz		TiN-K		
	cena / pár	EAN	cena / pár	EAN	cena / pár	EAN	cena / pár	EAN	cena / pár	EAN	
klika / klika	Kč €	1610,- 68,-	090857			2400,- 100,-	139174	1990,- 83,-	116502		
dozické	Kč €	2120,- 89,-	090864			3310,- 138,-	139181	2510,- 105,-	116519		
cyindrické	Kč €	2120,- 89,-	090871			3310,- 138,-	139198	2510,- 105,-	116526		
WC	Kč €	2580,- 108,-	090888			3770,- 158,-	139204	2980,- 125,-	116533		
koule / klika R	Kč €	2850,- 119,-	090895			4040,- 169,-	139211	3240,- 135,-	116540		
koule / klika L	Kč €	2850,- 119,-	090901			4040,- 169,-	139228	3240,- 135,-	116557		

	Magnetická rozeta										
	Objekt						Projekt tř. 4 (i protipožární)				
	NRz		TiN-K		K-industrial		NRz		TiN-K		
	cena / pár	EAN	cena / pár	EAN	cena / pár	EAN	cena / pár	EAN	cena / pár	EAN	
klika / klika	Kč €	1450,- 61,-	090970	2260,- 95,-	091038	2260,- 95,-	139235	1850,- 78,-	116564	2780,- 116,-	116625
dozické	Kč €	1960,- 82,-	090987	3170,- 133,-	091045	3170,- 133,-	139242	2370,- 99,-	116571	3700,- 155,-	116632
cyindrické	Kč €	1960,- 82,-	090994	3170,- 133,-	091052	3170,- 133,-	139259	2370,- 99,-	116588	3700,- 155,-	116649
WC	Kč €	2440,- 102,-	091007	3630,- 152,-	091069	3630,- 152,-	139266	2830,- 118,-	116595	4160,- 174,-	116656
koule / klika R	Kč €	2700,- 113,-	091014	3900,- 163,-	091076	3900,- 163,-	139273	3100,- 130,-	116601	4430,- 185,-	116663
koule / klika L	Kč €	2700,- 113,-	091021	3900,- 163,-	091083	3900,- 163,-	139280	3100,- 130,-	116618	4430,- 185,-	116670



NRz nerez - broušeno

**Hanna**

1610,- Kč  
68,- EUR

Kč	materiál: nerezová ocel povrch: NRz nerez - broušeno	EUR
1610,-		68,-
2120,-		89,-
2120,-		89,-
2580,-		108,-
2850,-		119,-
2850,-		119,-



TiN-K titan černý mat



**Sonia**

1450,- Kč  
61,- EUR

Kč	materiál: nerezová ocel povrch: NRz nerez - broušeno	EUR
1450,-		61,-
1960,-		82,-
1960,-		82,-
2440,-		102,-
2700,-		113,-
2700,-		113,-





	Magnetická rozeta										
	Objekt						Projekt tř. 4 (i protipožární)				
	NRz		TiN-K		K-industrial		NRz		TiN-K		
		cena / pár	EAN	cena / pár	EAN	cena / pár	EAN	cena / pár	EAN	cena / pár	EAN
klika / klika	Kč €	1610,- 68,-	114966	2550,- 107,-	115024	2550,- 107,-	139297	1990,- 83,-	116687	3070,- 128,-	116748
dozické	Kč €	2120,- 89,-	114973	3450,- 144,-	115031	3450,- 144,-	139303	2510,- 105,-	116694	3990,- 167,-	116755
cyindrické	Kč €	2120,- 89,-	114980	3450,- 144,-	115048	3450,- 144,-	139310	2510,- 105,-	116700	3990,- 167,-	116762
WC	Kč €	2580,- 108,-	114997	3920,- 164,-	115055	3920,- 164,-	139327	2980,- 125,-	116717	4460,- 186,-	116779
koule / klika R	Kč €	2850,- 119,-	115000	4180,- 175,-	115062	4180,- 175,-	139334	3240,- 135,-	116724	4730,- 198,-	116786
koule / klika L	Kč €	2850,- 119,-	115017	4180,- 175,-	115079	4180,- 175,-	139341	3240,- 135,-	116731	4730,- 198,-	116793

	Magnetická rozeta										
	Objekt						Projekt tř. 4 (i protipožární)				
	NRz		TiN-K		K-industrial		NRz		TiN-K		
		cena / pár	EAN	cena / pár	EAN	cena / pár	EAN	cena / pár	EAN	cena / pár	EAN
klika / klika	Kč €	1450,- 61,-	115086	2260,- 95,-	115147	2260,- 95,-	139358	1850,- 78,-	116809	2780,- 116,-	116861
dozické	Kč €	1960,- 82,-	115093	3170,- 133,-	115154	3170,- 133,-	139365	2370,- 99,-	116816	3700,- 155,-	116878
cyindrické	Kč €	1960,- 82,-	115109	3170,- 133,-	115161	3170,- 133,-	139372	2370,- 99,-	116823	3700,- 155,-	116885
WC	Kč €	2440,- 102,-	115116	3630,- 152,-	115178	3630,- 152,-	139389	2830,- 118,-	116830	4160,- 174,-	116892
koule / klika R	Kč €	2700,- 113,-	115123	3900,- 163,-	115185	3900,- 163,-	139396	3100,- 130,-	116847	4430,- 185,-	116908
koule / klika L	Kč €	2700,- 113,-	115130	3900,- 163,-	115192	3900,- 163,-	139402	3100,- 130,-	116854	4430,- 185,-	116915





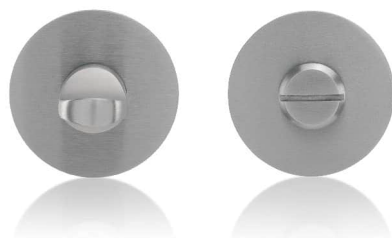

NRz nerez - broušeno



**Spodní rozety**

540,- Kč  
23,- EUR

Kč	materiál: nerezová ocel povrch: NRz nerez - broušeno	EUR
540,-		23,-
540,-		23,-
1000,-		42,-
670,-		28,-



TiN-K titan černý mat





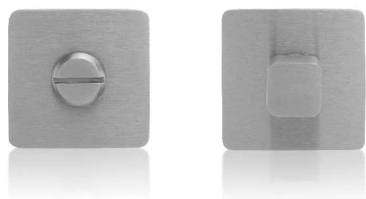

NRz nerez - broušeno



**Spodní rozety**

650,- Kč  
28,- EUR

Kč	materiál: nerezová ocel povrch: NRz nerez - broušeno	EUR
650,-		28,-
650,-		28,-
1190,-		50,-
790,-		33,-



TiN-K titan černý mat

		Magnetická rozeta					
		Objekt NRz		TiN-K		K-industrial	
		cena / pár	EAN	cena / pár	EAN	cena / pár	EAN
dozické	Kč €	540,- 23,-	091571	1000,- 42,-	091601	1000,- 42,-	140255
cylindrické	Kč €	540,- 23,-	091588	1000,- 42,-	091618	1000,- 42,-	140262
WC	Kč €	1000,- 42,-	091595	1460,- 61,-	091625	1460,- 61,-	140279
plná/zaslepovací	Kč €	670,- 28,-	104851	1140,- 48,-	104875	1140,- 48,-	140286

		Magnetická rozeta					
		Objekt NRz		TiN-K		K-industrial	
		cena / pár	EAN	cena / pár	EAN	cena / pár	EAN
dozické	Kč €	650,- 28,-	093551	1110,- 47,-	093582	1110,- 47,-	140293
cylindrické	Kč €	650,- 28,-	093568	1110,- 47,-	093599	1110,- 47,-	140309
WC	Kč €	1190,- 50,-	093575	1650,- 69,-	093605	1650,- 69,-	140316
plná/zaslepovací	Kč €	790,- 33,-	105032	1250,- 53,-	105056	1250,- 53,-	140323



NRz nerez - broušeno

**Lusy**

990,- Kč  
42,- EUR

materiál: nerezová ocel  
Kč povrch: NRz nerez - broušeno EUR

Kč		EUR
990,-		42,-
1630,-		68,-
1630,-		68,-
2160,-		90,-
2490,-		104,-
2490,-		104,-

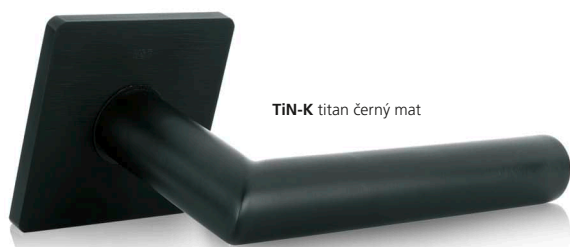

TiN-K titan černý mat



**Deny**

1170,- Kč  
49,- EUR

materiál: nerezová ocel  
Kč povrch: NRz nerez - broušeno EUR

Kč		EUR
1170,-		49,-
1810,-		76,-
1810,-		76,-
2330,-		98,-
2670,-		112,-
2670,-		112,-



Kliky v kategorii Projekt se vyrábějí jako protipožární a dodávají se včetně protipožárního nerezového čtyřhranu. Pro případ požadavku panikové funkce je třeba objednat variantu z kategorie dveřní kličky NEREZ str. 30 – 41. Dále je třeba objednat dělený čtyřhran a specifikovat přesnou délku čtyřhranu str. 377. Magnetické rozety se s panikovou funkcí nedodávají.

	Magnetická rozeta										
	Objekt							Projekt tř. 4 (i protipožární)			
	NRz		TiN-K		K-industrial		NRz		TiN-K		
	cena / pár	EAN	cena / pár	EAN	cena / pár	EAN	cena / pár	EAN	cena / pár	EAN	
klika / klika	Kč €	990,- 42,-	091632	1770,- 74,-	091694	1770,- 74,-	139419	1390,- 58,-	116922	2320,- 97,-	116984
dozické	Kč €	1630,- 68,-	091649	2820,- 118,-	091700	2820,- 118,-	139426	2030,- 85,-	116939	3360,- 140,-	116991
cyklindrické	Kč €	1630,- 68,-	091656	2820,- 118,-	091717	2820,- 118,-	139433	2030,- 85,-	116946	3360,- 140,-	117004
WC	Kč €	2160,- 90,-	091663	3360,- 140,-	091724	3360,- 140,-	139440	2560,- 107,-	116953	3890,- 163,-	117011
madlo / klika R	Kč €	2490,- 104,-	091670	3690,- 154,-	091731	3690,- 154,-	139457	2880,- 120,-	116960	4220,- 176,-	117028
madlo / klika L	Kč €	2490,- 104,-	091687	3690,- 154,-	091748	3690,- 154,-	139464	2880,- 120,-	116977	4220,- 176,-	117035

	Magnetická rozeta										
	Objekt							Projekt tř. 4 (i protipožární)			
	NRz		TiN-K		K-industrial		NRz		TiN-K		
	cena / pár	EAN	cena / pár	EAN	cena / pár	EAN	cena / pár	EAN	cena / pár	EAN	
klika / klika	Kč €	1170,- 49,-	091755	1950,- 82,-	091816	1950,- 82,-	139471	1550,- 65,-	117042	2490,- 104,-	117103
dozické	Kč €	1810,- 76,-	091762	3000,- 125,-	091823	3000,- 125,-	139488	2190,- 92,-	117059	3520,- 147,-	117110
cyklindrické	Kč €	1810,- 76,-	091779	3000,- 125,-	091830	3000,- 125,-	138495	2190,- 92,-	117066	3520,- 147,-	117127
WC	Kč €	2330,- 98,-	091786	3520,- 147,-	091847	3520,- 147,-	139501	2740,- 115,-	117073	4060,- 170,-	117134
madlo / klika R	Kč €	2670,- 112,-	091793	3870,- 162,-	091854	3870,- 162,-	139518	3070,- 128,-	117080	4400,- 184,-	117141
madlo / klika L	Kč €	2670,- 112,-	091809	3870,- 162,-	091861	3870,- 162,-	139525	3070,- 128,-	117097	4400,- 184,-	117158



NRz nerez - broušeno

**Meclis**

1450,- Kč  
61,- EUR

Kč	materiál: nerezová ocel povrch: NRz nerez - broušeno	EUR
1450,-		61,-
2090,-		88,-
2090,-		88,-
2610,-		109,-
2970,-		124,-
2970,-		124,-

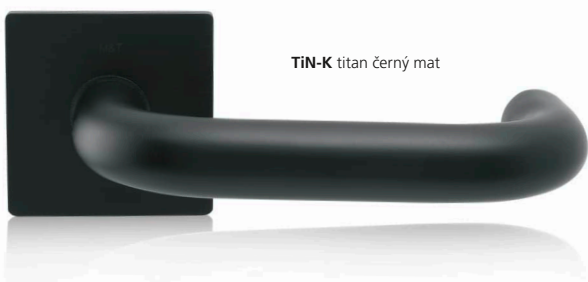

TiN-K titan černý mat



**Morgan**

1450,- Kč  
61,- EUR

Kč	materiál: nerezová ocel povrch: NRz nerez - broušeno	EUR
1450,-		61,-
2090,-		88,-
2090,-		88,-
2610,-		109,-
2970,-		124,-
2970,-		124,-



Kliky v kategorii Projekt se vyrábějí jako protipožární a dodávají se včetně protipožárního nerezového čtyřhranu. Pro případ požadavku panikové funkce je třeba objednat variantu z kategorie dveřní kličky NEREZ str. 30 – 41. Dále je třeba objednat dělený čtyřhran a specifikovat přesnou délku čtyřhranu str. 377. Magnetické rozety se s panikovou funkcí nedodávají.

		Magnetická rozeta									
		Objekt						Projekt tř. 4 (i protipožární)			
		NRz		TiN-K		K-industrial		NRz		TiN-K	
		cena / pár	EAN	cena / pár	EAN	cena / pár	EAN	cena / pár	EAN	cena / pár	EAN
klika / klika	Kč €	1450,- 61,-	091878	2260,- 95,-	091939	2260,- 95,-	139532	1850,- 78,-	117165	2780,- 116,-	117233
dozické	Kč €	2090,- 88,-	091885	3290,- 138,-	091946	3290,- 138,-	139549	2490,- 104,-	117172	3820,- 160,-	117240
cyklindrické	Kč €	2090,- 88,-	091892	3290,- 138,-	091953	3290,- 138,-	139556	2490,- 104,-	117189	3820,- 160,-	117257
WC	Kč €	2610,- 109,-	091908	3820,- 160,-	091960	3820,- 160,-	139563	3020,- 126,-	117202	4350,- 182,-	117264
madlo / klika R	Kč €	2970,- 124,-	091915	4160,- 174,-	091977	4160,- 174,-	139570	3380,- 141,-	117219	4700,- 196,-	117271
madlo / klika L	Kč €	2970,- 124,-	091922	4160,- 174,-	091984	4160,- 174,-	139587	3380,- 141,-	117226	4700,- 196,-	117288

		Magnetická rozeta									
		Objekt						Projekt tř. 4 (i protipožární)			
		NRz		TiN-K		K-industrial		NRz		TiN-K	
		cena / pár	EAN	cena / pár	EAN	cena / pár	EAN	cena / pár	EAN	cena / pár	EAN
klika / klika	Kč €	1450,- 61,-	091991	2260,- 95,-	092059	2260,- 95,-	139594	1850,- 78,-	117295	2780,- 116,-	117356
dozické	Kč €	2090,- 88,-	092004	3290,- 138,-	092066	3290,- 138,-	139600	2490,- 104,-	117301	3820,- 160,-	117363
cyklindrické	Kč €	2090,- 88,-	092011	3290,- 138,-	092073	3290,- 138,-	139617	2490,- 104,-	117318	3820,- 160,-	117370
WC	Kč €	2610,- 109,-	092028	3820,- 160,-	092080	3820,- 160,-	139624	3020,- 126,-	117325	4350,- 182,-	117387
madlo / klika R	Kč €	2970,- 124,-	092035	4160,- 174,-	092097	4160,- 174,-	139631	3380,- 141,-	117332	4700,- 196,-	117394
madlo / klika L	Kč €	2970,- 124,-	092042	4160,- 174,-	092103	4160,- 174,-	139648	3380,- 141,-	117349	4700,- 196,-	117400

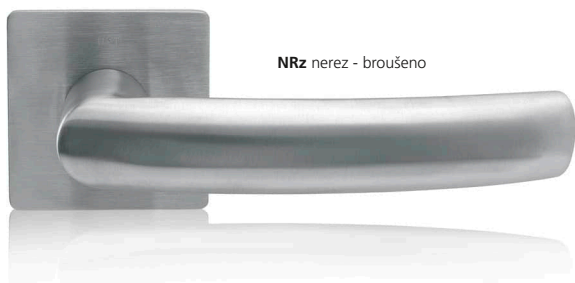

NRz nerez - broušeno

**Jameson**

1610,- Kč  
68,- EUR



TiN-K titan černý mat



**Nova**

1890,- Kč  
79,- EUR

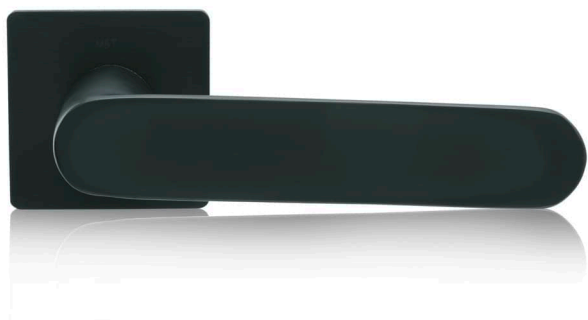

materiál: nerezová ocel  
povrch: NRz nerez - broušeno

KČ		EUR
1610,-		68,-
2240,-		94,-
2240,-		94,-
2770,-		116,-
3110,-		130,-
3110,-		130,-

materiál: nerezová ocel  
povrch: NRz nerez - broušeno

KČ		EUR
1890,-		79,-
2540,-		106,-
2540,-		106,-
3060,-		128,-
3410,-		143,-
3410,-		143,-

Kliky v kategorii Projekt se vyrábějí jako protipožární a dodávají se včetně protipožárního nerezového čtyřhranu. Pro případ požadavku panikové funkce je třeba objednat variantu z kategorie dveřní kličky NEREZ str. 30 – 41. Dále je třeba objednat dělený čtyřhran a specifikovat přesnou délku čtyřhranu str. 377. Magnetické rozety se s panikovou funkcí nedodávají.



		Magnetická rozeta									
		Objekt						Projekt tř. 4 (i protipožární)			
		NRz		TiN-K		K-industrial		NRz		TiN-K	
		cena / pár	EAN	cena / pár	EAN	cena / pár	EAN	cena / pár	EAN	cena / pár	EAN
klika / klika	Kč €	1610,- 68,-	092110	2390,- 100,-	092172	2390,- 100,-	139655	1990,- 83,-	117417	2930,- 123,-	117479
dozické	Kč €	2240,- 94,-	092127	3430,- 143,-	092189	3430,- 143,-	139662	2640,- 110,-	117424	3960,- 165,-	117486
cyklindrické	Kč €	2240,- 94,-	092134	3430,- 143,-	092196	3430,- 143,-	139679	2640,- 110,-	117431	3960,- 165,-	117493
WC	Kč €	2770,- 116,-	092141	3960,- 165,-	092202	3960,- 165,-	139686	3170,- 133,-	117448	4500,- 188,-	117509
madlo / klika R	Kč €	3110,- 130,-	092158	4320,- 180,-	092219	4320,- 180,-	139693	3390,- 142,-	117455	4840,- 202,-	117516
madlo / klika L	Kč €	3110,- 130,-	092165	4320,- 180,-	092226	4320,- 180,-	139709	3390,- 142,-	117462	4840,- 202,-	117523

		Magnetická rozeta									
		Objekt						Projekt tř. 4 (i protipožární)			
		NRz		TiN-K		K-industrial		NRz		TiN-K	
		cena / pár	EAN	cena / pár	EAN	cena / pár	EAN	cena / pár	EAN	cena / pár	EAN
klika / klika	Kč €	1890,- 79,-	092233	2690,- 113,-	092295	2690,- 113,-	139716	2290,- 96,-	117530	3220,- 135,-	117592
dozické	Kč €	2540,- 106,-	092240	3720,- 155,-	092301	3720,- 155,-	139723	2930,- 123,-	117547	4260,- 178,-	117608
cyklindrické	Kč €	2540,- 106,-	092257	3720,- 155,-	092318	3720,- 155,-	139730	2930,- 123,-	117554	4260,- 178,-	117615
WC	Kč €	3060,- 128,-	092264	4260,- 178,-	092325	4260,- 178,-	139747	3450,- 144,-	117561	4790,- 200,-	117622
madlo / klika R	Kč €	3410,- 143,-	092271	4600,- 192,-	092332	4600,- 192,-	139754	3810,- 159,-	117578	5150,- 215,-	117639
madlo / klika L	Kč €	3410,- 143,-	092288	4600,- 192,-	092349	4600,- 192,-	139761	3810,- 159,-	117585	5150,- 215,-	117646

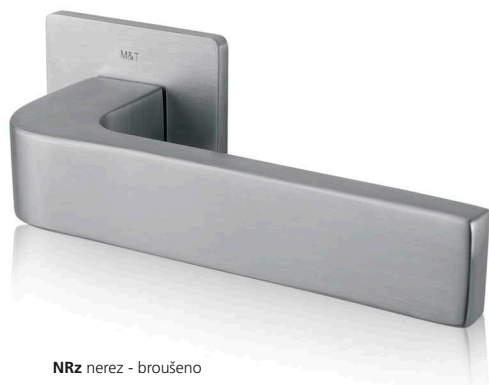

NRz nerez - broušeno



**Promo**

1890,- Kč  
79,- EUR

Kč	materiál: nerezová ocel povrch: NRz nerez - broušeno	EUR
1890,-		79,-
2540,-		106,-
2540,-		106,-
3060,-		128,-
3410,-		143,-
3410,-		143,-

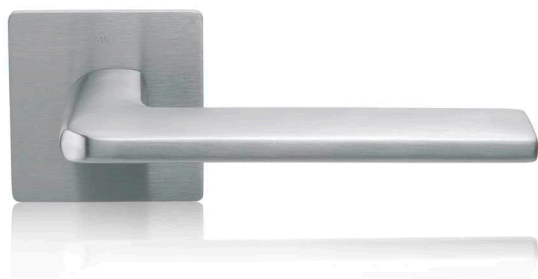

**Senza**

1740,- Kč  
73,- EUR



Kč	materiál: nerezová ocel povrch: NRz nerez - broušeno	EUR
1740,-		73,-
2280,-		95,-
2280,-		95,-
2920,-		122,-
3260,-		136,-
3260,-		136,-

Kliky v kategorii Projekt se vyrábějí jako protipožární a dodávají se včetně protipožárního nerezového čtyřhranu. Pro případ požadavku panikové funkce je třeba objednat variantu z kategorie dveřní kličky NEREZ str. 30 – 41. Dále je třeba objednat dělený čtyřhran a specifikovat přesnou délku čtyřhranu str. 377. Magnetické rozety se s panikovou funkcí nedodávají.

	Magnetická rozeta										
	Objekt						Projekt tř. 4 (i protipožární)				
	NRz		TiN-K		K-industrial		NRz		TiN-K		
	cena / pár	EAN	cena / pár	EAN	cena / pár	EAN	cena / pár	EAN	cena / pár	EAN	
klika / klika	Kč €	1890,- 79,-	092479			2690,- 113,-	139778	2290,- 96,-	117714		
dozické	Kč €	2540,- 106,-	092486			3720,- 155,-	139785	2930,- 123,-	117721		
cyklindrické	Kč €	2540,- 106,-	092493			3720,- 155,-	139792	2930,- 123,-	117738		
WC	Kč €	3060,- 128,-	092509			4250,- 178,-	139808	3450,- 144,-	117745		
madlo / klika R	Kč €	3410,- 143,-	092516			4600,- 192,-	139815	3810,- 159,-	117752		
madlo / klika L	Kč €	3410,- 143,-	092523			4600,- 192,-	139822	3810,- 159,-	117769		

	Magnetická rozeta										
	Objekt						Projekt tř. 4 (i protipožární)				
	NRz		TiN-K		K-industrial		NRz		TiN-K		
	cena / pár	EAN	cena / pár	EAN	cena / pár	EAN	cena / pár	EAN	cena / pár	EAN	
klika / klika	Kč €	1740,- 73,-	092356			2550,- 107,-	139839	2140,- 90,-	117653		
dozické	Kč €	2280,- 95,-	092363			3480,- 145,-	139846	2780,- 116,-	117660		
cyklindrické	Kč €	2280,- 95,-	092370			3480,- 145,-	139853	2780,- 116,-	117677		
WC	Kč €	2920,- 122,-	092387			4120,- 172,-	139860	3310,- 138,-	117684		
madlo / klika R	Kč €	3260,- 136,-	092394			4450,- 186,-	139877	3660,- 153,-	117691		
madlo / klika L	Kč €	3260,- 136,-	092400			4450,- 186,-	139884	3660,- 153,-	117707		

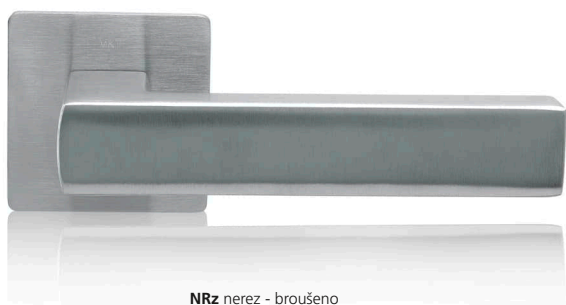

NRz nerez - broušeno

**Kvadra**

1890,- Kč  
79,- EUR



TiN-K titan černý mat

Kč	materiál: nerezová ocel povrch: NRz nerez - broušeno	EUR
1890,-		79,-
2540,-		106,-
2540,-		106,-
3060,-		128,-
3410,-		143,-
3410,-		143,-



**Entero**

1890,- Kč  
79,- EUR



Kč	materiál: nerezová ocel povrch: NRz nerez - broušeno	EUR
1890,-		79,-
2540,-		106,-
2540,-		106,-
3060,-		128,-
3410,-		143,-
3410,-		143,-

Kliky v kategorii Projekt se vyrábějí jako protipožární a dodávají se včetně protipožárního nerezového čtyřhranu. Pro případ požadavku panikové funkce je třeba objednat variantu z kategorie dveřní kličky NEREZ str. 30 – 41. Dále je třeba objednat dělený čtyřhran a specifikovat přesnou délku čtyřhranu str. 377. Magnetické rozety se s panikovou funkcí nedodávají.

		Magnetická rozeta									
		Objekt						Projekt tř. 4 (i protipožární)			
		NRz		TiN-K		K-industrial		NRz		TiN-K	
		cena / pár	EAN	cena / pár	EAN	cena / pár	EAN	cena / pár	EAN	cena / pár	EAN
klika / klika	Kč €	1890,- 79,-	092714	2690,- 113,-	092776	2690,- 113,-	139891	2290,- 96,-	117899	3220,- 135,-	117950
dozické	Kč €	2540,- 106,-	092721	3720,- 155,-	092783	3720,- 155,-	139907	2930,- 123,-	117905	4260,- 178,-	117967
cyklindrické	Kč €	2540,- 106,-	092738	3720,- 155,-	092790	3720,- 155,-	139914	2930,- 123,-	117912	4260,- 178,-	117974
WC	Kč €	3060,- 128,-	092745	4260,- 178,-	092806	4260,- 178,-	139921	3450,- 144,-	117929	4790,- 200,-	117981
madlo / klika R	Kč €	3410,- 143,-	092752	4600,- 192,-	092813	4600,- 192,-	139938	3810,- 159,-	117936	5270,- 220,-	117998
madlo / klika L	Kč €	3410,- 143,-	092769	4600,- 192,-	092820	4600,- 192,-	139945	3810,- 159,-	117943	5270,- 220,-	118001

		Magnetická rozeta									
		Objekt						Projekt tř. 4 (i protipožární)			
		NRz		TiN-K		K-industrial		NRz		TiN-K	
		cena / pár	EAN	cena / pár	EAN	cena / pár	EAN	cena / pár	EAN	cena / pár	EAN
klika / klika	Kč €	1890,- 79,-	092592	2690,- 113,-	092653	2690,- 113,-	139952	2290,- 96,-	117776	3220,- 135,-	117837
dozické	Kč €	2540,- 106,-	092608	3720,- 155,-	092660	3720,- 155,-	139969	2930,- 123,-	117783	4260,- 178,-	117844
cyklindrické	Kč €	2540,- 106,-	092615	3720,- 155,-	092677	3720,- 155,-	139976	2930,- 123,-	117790	4260,- 178,-	117851
WC	Kč €	3060,- 128,-	092622	4260,- 178,-	092684	4260,- 178,-	139983	3450,- 144,-	117806	4790,- 200,-	117868
madlo / klika R	Kč €	3410,- 143,-	092639	4600,- 192,-	092691	4600,- 192,-	139990	3810,- 159,-	117813	6010,- 251,-	117875
madlo / klika L	Kč €	3410,- 143,-	092646	4600,- 192,-	092707	4600,- 192,-	140002	3810,- 159,-	117820	6010,- 251,-	117882



NRz nerez - broušeno

**Techno**

1890,- Kč  
79,- EUR



materiál: nerezová ocel  
povrch: NRz nerez - broušeno

Kč		EUR
1890,-		79,-
2540,-		106,-
2540,-		106,-
3060,-		128,-
3410,-		143,-
3410,-		143,-



**Cesan**

1740,- Kč  
73,- EUR



materiál: nerezová ocel  
povrch: NRz nerez - broušeno

Kč		EUR
1740,-		73,-
2380,-		100,-
2380,-		100,-
2920,-		122,-
3260,-		136,-
3260,-		136,-

Kliky v kategorii Projekt se vyrábějí jako protipožární a dodávají se včetně protipožárního nerezového čtyřhranu. Pro případ požadavku panikové funkce je třeba objednat variantu z kategorie dveřní kličky NEREZ str. 30 – 41. Dále je třeba objednat dělený čtyřhran a specifikovat přesnou délku čtyřhranu str. 377. Magnetické rozety se s panikovou funkcí nedodávají.

	Magnetická rozeta										
	Objekt						Projekt tř. 4 (i protipožární)				
	NRz		TiN-K		K-industrial		NRz		TiN-K		
	cena / pár	EAN	cena / pár	EAN	cena / pár	EAN	cena / pár	EAN	cena / pár	EAN	
klika / klika	Kč €	1890,- 79,-	092837			2690,- 113,-	140019	2290,- 96,-	118018		
dozické	Kč €	2540,- 106,-	092844			3720,- 155,-	140026	2930,- 123,-	118025		
cyindrické	Kč €	2540,- 106,-	092851			3720,- 155,-	140033	2930,- 123,-	118032		
WC	Kč €	3060,- 128,-	092868			4250,- 178,-	140040	3450,- 144,-	118049		
madlo / klika R	Kč €	3410,- 143,-	092875			4600,- 192,-	140057	3810,- 159,-	118056		
madlo / klika L	Kč €	3410,- 143,-	092882			4600,- 192,-	140064	3810,- 159,-	118063		

	Magnetická rozeta										
	Objekt						Projekt tř. 4 (i protipožární)				
	NRz		TiN-K		K-industrial		NRz		TiN-K		
	cena / pár	EAN	cena / pár	EAN	cena / pár	EAN	cena / pár	EAN	cena / pár	EAN	
klika / klika	Kč €	1740,- 73,-	092950	2550,- 107,-	093018	2550,- 107,-	140071	2140,- 90,-	118070	3070,- 128,-	118131
dozické	Kč €	2380,- 100,-	092967	3590,- 150,-	093025	3590,- 150,-	140088	2780,- 116,-	118087	4120,- 172,-	118148
cyindrické	Kč €	2380,- 100,-	092974	3590,- 150,-	093032	3590,- 150,-	140095	2780,- 116,-	118094	4120,- 172,-	118155
WC	Kč €	2920,- 122,-	092981	4120,- 172,-	093049	4120,- 172,-	140101	3310,- 138,-	118100	4640,- 194,-	118162
madlo / klika R	Kč €	3260,- 136,-	092998	4460,- 186,-	093056	4460,- 186,-	140018	3660,- 153,-	118117	4990,- 208,-	118179
madlo / klika L	Kč €	3260,- 136,-	093001	4460,- 186,-	093063	4460,- 186,-	140125	3660,- 153,-	118124	4990,- 208,-	118186

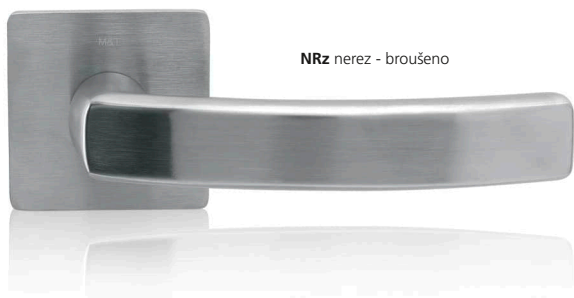

NRz nerez - broušeno

**Sonia**

1480,- Kč  
62,- EUR

materiál: nerezová ocel  
Kč povrch: NRz nerez - broušeno EUR

Kč	materiál: nerezová ocel povrch: NRz nerez - broušeno	EUR
1480,-		62,-
2120,-		89,-
2120,-		89,-
2660,-		111,-
3160,-		132,-
3160,-		132,-



TiN-K titan černý mat



**Hanna**

1890,- Kč  
79,- EUR

materiál: nerezová ocel  
Kč povrch: NRz nerez - broušeno EUR

Kč	materiál: nerezová ocel povrch: NRz nerez - broušeno	EUR
1890,-		79,-
2540,-		106,-
2540,-		106,-
3060,-		128,-
3410,-		143,-
3410,-		143,-



Kliky v kategorii Projekt se vyrábějí jako protipožární a dodávají se včetně protipožárního nerezového čtyřhranu. Pro případ požadavku panikové funkce je třeba objednat variantu z kategorie dveřní kličky NEREZ str. 30 – 41. Dále je třeba objednat dělený čtyřhran a specifikovat přesnou délku čtyřhranu str. 377. Magnetické rozety se s panikovou funkcí nedodávají.



	Magnetická rozeta										
	Objekt						Projekt tř. 4 (i protipožární)				
	NRz		TiN-K		K-industrial		NRz		TiN-K		
	cena / pár	EAN	cena / pár	EAN	cena / pár	EAN	cena / pár	EAN	cena / pár	EAN	
klika / klika	Kč €	1480,- 62,-	103359	2370,- 99,-	103410	2370,- 99,-	140132	1880,- 79,-	118193	2890,- 121,-	118254
dozické	Kč €	2120,- 89,-	103366	3440,- 144,-	103427	3440,- 144,-	140149	2510,- 105,-	118209	3990,- 167,-	118261
cyklindrické	Kč €	2120,- 89,-	103373	3440,- 144,-	103434	3440,- 144,-	140156	2510,- 105,-	118216	3990,- 167,-	118278
WC	Kč €	2660,- 111,-	103380	3990,- 167,-	103441	3990,- 167,-	140163	3050,- 128,-	118223	4520,- 189,-	118285
madlo / klika R	Kč €	3160,- 132,-	103397	4480,- 187,-	103458	4480,- 187,-	140170	3540,- 148,-	118230	5010,- 209,-	118292
madlo / klika L	Kč €	3160,- 132,-	103403	4480,- 187,-	103465	4480,- 187,-	140187	3540,- 148,-	118247	5010,- 209,-	118308

	Magnetická rozeta										
	Objekt						Projekt tř. 4 (i protipožární)				
	NRz		TiN-K		K-industrial		NRz		TiN-K		
	cena / pár	EAN	cena / pár	EAN	cena / pár	EAN	cena / pár	EAN	cena / pár	EAN	
klika / klika	Kč €	1890,- 79,-	115208	2690,- 113,-	115260	2690,- 113,-	140194	2290,- 96,-	118315	3220,- 135,-	118377
dozické	Kč €	2540,- 106,-	115215	3720,- 155,-	115277	3720,- 155,-	140200	2930,- 123,-	118322	4260,- 178,-	118384
cyklindrické	Kč €	2540,- 106,-	115222	3720,- 155,-	115284	3720,- 155,-	140217	2930,- 123,-	118339	4260,- 178,-	118391
WC	Kč €	3060,- 128,-	115239	4260,- 178,-	115291	4260,- 178,-	140224	3450,- 144,-	118346	4790,- 200,-	118407
madlo / klika R	Kč €	3410,- 143,-	115246	4600,- 192,-	115307	4600,- 192,-	140231	3810,- 159,-	118353	5150,- 215,-	118414
madlo / klika L	Kč €	3410,- 143,-	115253	4600,- 192,-	115314	4600,- 192,-	140248	3810,- 159,-	118360	5150,- 215,-	118421

## System plochých a zapuštěných rozet

Univerzální konstrukce umožňuje montáž klik s magnetickou rozetou buď přisazením na dveřní křídlo tj. systém plochých rozet nebo vložení/zafrézováním do dveřního křídla tj. systém zcela zapuštěných rozet.

vrtání otvorů pro MG rozety

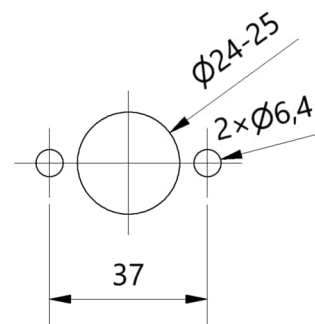

Při montáži systémem zapuštěných rozet si před výrobou dveří ověřte vhodnost/možnost zapuštění magnetických rozet do stěny dveřního křídla s ohledem na umístění dveřního zámku u falcových a reversních dveří.





Celý projekt - jeden design

Dveřní kliky DESIGN 2000, 2004



Kování pro hliníkové a ocelové dveře, kování na branky



Kliky a zámky na skleněné dveře



Panty na skleněné dveře



Madla a koule na skleněné a dřevěné dveře



Mušle na posuvné dveře



Panty na dřevěné dveře



Bezpečnostní rozety



Okenní kliky 3 a 4 polohové



Bezpečnostní madla Entero



Madla dlouhá



## Dveřní kliky DESIGN 2000, 2004

Materiál: masivní mosaz

Povrchy: SNI, SNI - broušeno, Cr, TiN-C, TiN-K, Ms, Ms-L, Ms-A, zakázkově TiN-S, TiN-A  
více info na [www.kliky-mt.cz/manufaktura/barvy-povrchy](http://www.kliky-mt.cz/manufaktura/barvy-povrchy)

Kování vyráběné od roku 2000 na kulatých rozetách a od roku 2004 na čtvercových rozetách, kdy se jednalo o první kolekci klik na hranatých rozetách v Evropě. Lídrem celé kolekce je klika Entero, která už více jak 18 let patří k nejoblíbenějším klikám v nabídce M&T díky svému tvaru, dokonalé ergonomii a jednoduché, ale zároveň kvalitní montáži. Tento typ konstrukce a montáže je velkou předností celé kolekce klik DESIGN 2000 a 2004.

SOGUT **SNI** matný nikl

ENTERO **SNI-broušeno** matný nikl broušeno

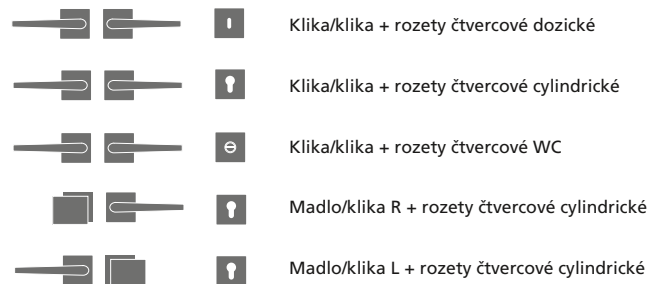

dozické    cylindrické    WC in    WC ex    koule Maty

rozety Ø 52 mm

zaslepovací    koule Fábi



dozické    cylindrické    WC in    WC ex    zaslepovací

rozety 52x52 mm

madlo Entero

### konstrukční varianty, materiálové provedení

- kování s vratnou pružinou
- sada vč. spodních rozet
- sešroubování pouzdry proti sobě
- rukojeti vyrobeny z masivní mosazi
- zajišťovací gel proti uvolnění šroubů
- vrtání PROFI šablonou M&T vrtákem Ø 6,4 mm
- animace montáže na [www.kliky-mt.cz/montaze-kovani](http://www.kliky-mt.cz/montaze-kovani)
- montáž pro tloušťky dveří 38 – 126 mm
- možnost dodání v protipožárním provedení
- v balení standardně montážní materiál pro tl. dveří 38 - 45 mm
- záruka 3 roky, titany 15 let, mosaz natural doživotní

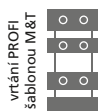

roky **3 garance** let **15 garance**

Ochranná známka – registrovaná značka **ENTERO®**



Chráněné průmyslové vzory klik



**ENTERO**  
**BURAK**  
**MIA**  
**SOGUT**



SNi matný nikel

**Cesan**

1400,- Kč  
59,- EUR



TIN-K titan černý mat

**Garanti**

1460,- Kč  
61,- EUR



Cr lesklý chrom

**Burak**

1520,- Kč  
64,- EUR



SNi matný nikel

**Fábi**

1670,- Kč  
70,- EUR



Ms mosaz natural

**Andy**

1670,- Kč  
70,- EUR



SNi matný nikel

**Mondeo**

2010,- Kč  
84,- EUR

Kč	materiál: masivní mosaz povrch: SNi matný nikel			EUR
1400,-				59,-
1400,-				59,-
2120,-				89,-
2220,-				93,-
2220,-				93,-
1460,-				61,-
1460,-				61,-
2170,-				91,-
2270,-				95,-
2270,-				95,-
1520,-				64,-
1520,-				64,-
2240,-				94,-
2330,-				98,-
2330,-				98,-
1670,-				70,-
1670,-				70,-
2390,-				100,-
2490,-				104,-
2490,-				104,-
1670,-				70,-
1670,-				70,-
2390,-				100,-
2490,-				104,-
2490,-				104,-
2010,-				84,-
2010,-				84,-
2720,-				114,-
2800,-				117,-
2800,-				117,-

Povrchy TIN-S, TIN-A, Ms-L, Ms-A – více na [www.kliky-mt.cz/katalog](http://www.kliky-mt.cz/katalog)  
Protipožární provedení (kovové podrozety + nerezové spojovací prvky, čtyřhran) ... příplatek 490,- Kč ... EAN 082289  
Provedení panikové pro zámky s děleným čtyřhranem je s příplatkem 260,- Kč (EAN 101409) k ceně provedení klika / klika.  
Dělený čtyřhran se objednává zvlášť a je třeba specifikovat přesnou délku čtyřhranu, str. 377.



		SNI		Cr		Ms		Ms-A		TiN-C		TiN-K	
		cena pár	EAN	cena pár	EAN	cena pár	EAN	cena pár	EAN	cena pár	EAN	cena pár	EAN
dozické	Kč €	1400,- 59,-	20252	1720,- 72,-	20610	1720,- 72,-	050356	1890,- 79,-	096101	2650,- 111,-	21105	2650,- 111,-	20344
cyldrické	Kč €	1400,- 59,-	20269	1720,- 72,-	20627	1720,- 72,-	050363	1890,- 79,-	096118	2650,- 111,-	21112	2650,- 111,-	20351
WC	Kč €	2120,- 89,-	20276	2440,- 102,-	20634	2440,- 102,-	050370	2680,- 112,-	096125	3510,- 147,-	21099	3510,- 147,-	20368
koule / klika R	Kč €	2220,- 93,-	20900	2540,- 106,-	20924	2540,- 106,-	050387	2780,- 116,-	096132	3620,- 151,-	20962	3620,- 151,-	20986
koule / klika L	Kč €	2220,- 93,-	20917	2540,- 106,-	20931	2540,- 106,-	050394	2780,- 116,-	096149	3620,- 151,-	20979	3620,- 151,-	20993
dozické	Kč €	1460,- 61,-	20375	1760,- 74,-	20764	1760,- 74,-	050509	1940,- 81,-	096200	2700,- 113,-	21129	2700,- 113,-	20467
cyldrické	Kč €	1460,- 61,-	20382	1760,- 74,-	20771	1760,- 74,-	050516	1940,- 81,-	096217	2700,- 113,-	21136	2700,- 113,-	20474
WC	Kč €	2170,- 91,-	20399	2480,- 104,-	20788	2480,- 104,-	050523	2720,- 114,-	096224	3580,- 150,-	20429	3580,- 150,-	20481
koule / klika R	Kč €	2270,- 95,-	20801	2570,- 108,-	20825	2570,- 108,-	050530	2820,- 118,-	096231	3660,- 153,-	20863	3660,- 153,-	20887
koule / klika L	Kč €	2270,- 95,-	20818	2570,- 108,-	20832	2570,- 108,-	050547	2820,- 118,-	096248	3660,- 153,-	20870	3660,- 153,-	20894
dozické	Kč €	1520,- 64,-	20498	1830,- 77,-	20641	1830,- 77,-	050653	2010,- 84,-	096057	2760,- 115,-	21303	2760,- 115,-	20580
cyldrické	Kč €	1520,- 64,-	20504	1830,- 77,-	20658	1830,- 77,-	050660	2010,- 84,-	096064	2760,- 115,-	21310	2760,- 115,-	20597
WC	Kč €	2240,- 94,-	20511	2550,- 107,-	20665	2550,- 107,-	050677	2790,- 117,-	096071	3630,- 152,-	21327	3630,- 152,-	20603
koule / klika R	Kč €	2330,- 98,-	23307	2650,- 111,-	23321	2650,- 111,-	050684	2910,- 122,-	096088	3720,- 155,-	23369	3720,- 155,-	23383
koule / klika L	Kč €	2330,- 98,-	23314	2650,- 111,-	23338	2650,- 111,-	050691	2910,- 122,-	096095	3720,- 155,-	23376	3720,- 155,-	23390
dozické	Kč €	1670,- 70,-	23840	1980,- 83,-	23871	1980,- 83,-	050806	2180,- 91,-	096156	2920,- 122,-	23932	2920,- 122,-	23963
cyldrické	Kč €	1670,- 70,-	23857	1980,- 83,-	23888	1980,- 83,-	050813	2180,- 91,-	096163	2920,- 122,-	23949	2920,- 122,-	23970
WC	Kč €	2390,- 100,-	23864	2700,- 113,-	23895	2700,- 113,-	050820	2970,- 124,-	096170	3800,- 159,-	23956	3800,- 159,-	23987
koule / klika R	Kč €	2490,- 104,-	32255	2790,- 117,-	32279	2790,- 117,-	050837	3070,- 128,-	096187	3890,- 163,-	32316	3890,- 163,-	32330
koule / klika L	Kč €	2490,- 104,-	32262	2790,- 117,-	32286	2790,- 117,-	050844	3070,- 128,-	096194	3890,- 163,-	32323	3890,- 163,-	32347
dozické	Kč €	1670,- 70,-	60005	1980,- 83,-	60050	1980,- 83,-	050950	2180,- 91,-	096002	2920,- 122,-	60159	2920,- 122,-	60203
cyldrické	Kč €	1670,- 70,-	60012	1980,- 83,-	60067	1980,- 83,-	050967	2180,- 91,-	096019	2920,- 122,-	60166	2920,- 122,-	60210
WC	Kč €	2390,- 100,-	60029	2700,- 113,-	60074	2700,- 113,-	050974	2970,- 124,-	096026	3800,- 159,-	60173	3800,- 159,-	60227
koule / klika R	Kč €	2490,- 104,-	60036	2790,- 117,-	60081	2790,- 117,-	050981	3070,- 128,-	096033	3890,- 163,-	60180	3890,- 163,-	60234
koule / klika L	Kč €	2490,- 104,-	60043	2790,- 117,-	60098	2790,- 117,-	050998	3070,- 128,-	096040	3890,- 163,-	60197	3890,- 163,-	60241
dozické	Kč €	2010,- 84,-	60302	2320,- 97,-	60357	2320,- 97,-	051100	2550,- 107,-	096255	3240,- 135,-	60456	3240,- 135,-	60500
cyldrické	Kč €	2010,- 84,-	60319	2320,- 97,-	60364	2320,- 97,-	051117	2550,- 107,-	096262	3240,- 135,-	60463	3240,- 135,-	60517
WC	Kč €	2720,- 114,-	60326	3020,- 126,-	60371	3020,- 126,-	051124	3320,- 139,-	096279	4120,- 172,-	60470	4120,- 172,-	60524
koule / klika R	Kč €	2800,- 117,-	60333	3130,- 131,-	60388	3130,- 131,-	051131	3430,- 143,-	096286	4200,- 175,-	60487	4200,- 175,-	60531
koule / klika L	Kč €	2800,- 117,-	60340	3130,- 131,-	60395	3130,- 131,-	051148	3430,- 143,-	096293	4200,- 175,-	60494	4200,- 175,-	60548

U kombinace koule / klika dodáváme standardně kouli Fábi pevnou - neotočnou. Na základě požadavku kouli Maty pevnou - neotočnou. Lze dodat kouli Fábi otočnou s funkcí kliky. V balení je standardně montážní materiál pro tl. dveří 38 - 45 mm. Pro větší tloušťky dveří je potřeba specifikovat jiný montážní materiál viz. Příslušenství a komponenty str. 376.



SNi matný nikl

**Kemer**

1840,- Kč  
77,- EUR



Cr lesklý chrom

**Deny**

1520,- Kč  
64,- EUR



TiN-C titan chrom mat

**Lusy**

1520,- Kč  
64,- EUR



SNi matný nikl

**Maty**

2010,- Kč  
84,- EUR

Kč	materiál: masivní mosaz povrch: SNi matný nikl			EUR
1840,-				77,-
1840,-				77,-
2550,-				107,-
2660,-				111,-
2660,-				111,-
1520,-				64,-
1520,-				64,-
2260,-				95,-
2330,-				98,-
2330,-				98,-
1520,-				64,-
1520,-				64,-
2260,-				95,-
2330,-				98,-
2330,-				98,-
2010,-				84,-
2010,-				84,-
2740,-				115,-
2800,-				117,-
2800,-				117,-





		SNI		Cr		Ms		Ms-A		TiN-C		TiN-K	
		cena pár	EAN	cena pár	EAN	cena pár	EAN	cena pár	EAN	cena pár	EAN	cena pár	EAN
dozické	Kč €	1840,- 77,-	21808	2160,- 90,-	20733	2160,- 90,-	051254	2370,- 99,-	096354	3080,- 129,-	21860	3080,- 129,-	21891
cylindrické	Kč €	1840,- 77,-	21815	2160,- 90,-	20740	2160,- 90,-	051261	2370,- 99,-	096361	3080,- 129,-	21877	3080,- 129,-	21907
WC	Kč €	2550,- 107,-	21822	2860,- 120,-	20757	2860,- 120,-	051278	3140,- 131,-	096378	3940,- 165,-	21921	3940,- 165,-	21914
koule / klika R	Kč €	2660,- 111,-	23406	2970,- 124,-	23420	2970,- 124,-	051285	3260,- 136,-	096385	4060,- 170,-	23468	4060,- 170,-	23482
koule / klika L	Kč €	2660,- 111,-	23413	2970,- 124,-	23437	2970,- 124,-	051292	3260,- 136,-	096392	4060,- 170,-	23475	4060,- 170,-	23499
dozické	Kč €	1520,- 64,-	23062	1830,- 77,-	23093	1830,- 77,-	051407	2010,- 84,-	096309	2760,- 115,-	32651	2760,- 115,-	32705
cylindrické	Kč €	1520,- 64,-	23079	1830,- 77,-	23109	1830,- 77,-	051414	2010,- 84,-	096316	2760,- 115,-	32668	2760,- 115,-	32712
WC	Kč €	2260,- 95,-	23086	2560,- 107,-	23116	2560,- 107,-	051421	2800,- 117,-	096323	3640,- 152,-	32675	3640,- 152,-	32729
koule / klika R	Kč €	2330,- 98,-	23642	2650,- 111,-	23666	2650,- 111,-	051438	2910,- 122,-	096330	3720,- 155,-	32682	3720,- 155,-	32736
koule / klika L	Kč €	2330,- 98,-	23659	2650,- 111,-	23673	2650,- 111,-	051445	2910,- 122,-	096347	3720,- 155,-	32699	3720,- 155,-	32743
dozické	Kč €	1520,- 64,-	23178	1830,- 77,-	23246	1830,- 77,-	051551	2010,- 84,-	096408	2760,- 115,-	32552	2760,- 115,-	25905
cylindrické	Kč €	1520,- 64,-	23185	1830,- 77,-	23253	1830,- 77,-	051568	2010,- 84,-	096415	2760,- 115,-	32569	2760,- 115,-	25912
WC	Kč €	2260,- 95,-	23192	2560,- 107,-	23260	2560,- 107,-	051575	2800,- 117,-	096422	3640,- 152,-	32576	3640,- 152,-	25929
koule / klika R	Kč €	2330,- 98,-	23604	2650,- 111,-	23628	2650,- 111,-	051582	2910,- 122,-	096439	3720,- 155,-	32583	3720,- 155,-	25936
koule / klika L	Kč €	2330,- 98,-	23611	2650,- 111,-	23635	2650,- 111,-	051599	2910,- 122,-	096446	3720,- 155,-	32590	3720,- 155,-	25943
dozické	Kč €	2010,- 84,-	20016	2320,- 97,-	20061	2320,- 97,-	051704	2550,- 107,-	096453	3240,- 135,-	20160	3240,- 135,-	20214
cylindrické	Kč €	2010,- 84,-	20023	2320,- 97,-	20078	2320,- 97,-	051711	2550,- 107,-	096460	3240,- 135,-	20177	3240,- 135,-	20221
WC	Kč €	2740,- 115,-	20030	3030,- 127,-	20085	3030,- 127,-	051728	3330,- 139,-	096477	4130,- 173,-	20184	4130,- 173,-	20238
koule / klika R	Kč €	2800,- 117,-	20047	3130,- 131,-	20092	3130,- 131,-	051735	3430,- 143,-	096484	4200,- 175,-	20191	4200,- 175,-	20245
koule / klika L	Kč €	2800,- 117,-	20054	3130,- 131,-	20108	3130,- 131,-	051742	3430,- 143,-	096491	4200,- 175,-	20207	4200,- 175,-	20306

V balení je standardně montážní materiál pro tl. dveří 38 - 45 mm. Pro větší tloušťky dveří je potřeba specifikovat jiný montážní materiál viz. Příslušenství a komponenty str. 376.



**Mia**

1520,- Kč  
64,- EUR



**Sogut**

1770,- Kč  
74,- EUR



**Meclis**

1540,- Kč  
65,- EUR



**Cherez**

2260,- Kč  
95,- EUR

Kč	materiál: masivní mosaz povrch: SNi matný nikl			EUR
1520,-				64,-
1520,-				64,-
2260,-				95,-
2330,-				98,-
2330,-				98,-
1770,-				74,-
1770,-				74,-
2500,-				105,-
2610,-				109,-
2610,-				109,-
1540,-				65,-
1540,-				65,-
2280,-				95,-
2380,-				100,-
2380,-				100,-
2260,-				95,-
2260,-				95,-
3110,-				130,-
3360,-				140,-
3360,-				140,-
320,-				14,-

Povrchy TIN-S, TIN-A, Ms-L, Ms-A – více na [www.kliky-mt.cz/katalog](http://www.kliky-mt.cz/katalog)  
 Protipožární provedení (kovové podrozety + nerezové spojovací prvky, čtyřhran) ... příplatek 490,- Kč ... EAN 082289  
 Provedení panikové pro zámky s děleným čtyřhranem je s příplatkem 260,- Kč (EAN 101409) k ceně provedení klika / klika.  
 Dělený čtyřhran se objednává zvlášť a je třeba specifikovat přesnou délku čtyřhranu, str. 377.



		SNI		Cr		Ms		Ms-A		TiN-C		TiN-K	
		cena pár	EAN	cena pár	EAN	cena pár	EAN	cena pár	EAN	cena pár	EAN	cena pár	EAN
dozické	Kč €	1520,- 64,-	23703	1830,- 77,-	23758	1830,- 77,-	051858	2010,- 84,-	096606	2760,- 115,-	25806	2760,- 115,-	25851
cylindrické	Kč €	1520,- 64,-	23710	1830,- 77,-	23765	1830,- 77,-	051865	2010,- 84,-	096613	2760,- 115,-	25813	2760,- 115,-	25868
WC	Kč €	2260,- 95,-	23727	2560,- 107,-	23772	2560,- 107,-	051872	2800,- 117,-	096620	3640,- 152,-	25820	3640,- 152,-	25875
koule / klika R	Kč €	2330,- 98,-	23734	2650,- 111,-	23789	2650,- 111,-	051889	2910,- 122,-	096637	3720,- 155,-	25837	3720,- 155,-	25882
koule / klika L	Kč €	2330,- 98,-	23741	2650,- 111,-	23796	2650,- 111,-	051896	2910,- 122,-	096644	3720,- 155,-	25844	3720,- 155,-	25899
dozické	Kč €	1770,- 74,-	21501	2090,- 88,-	32156	2090,- 88,-	052008	2290,- 96,-	096651	3020,- 126,-	32200	3020,- 126,-	21587
cylindrické	Kč €	1770,- 74,-	21518	2090,- 88,-	32163	2090,- 88,-	052015	2290,- 96,-	096668	3020,- 126,-	32217	3020,- 126,-	21594
WC	Kč €	2500,- 105,-	21525	2800,- 117,-	32170	2800,- 117,-	052022	3080,- 129,-	096675	3900,- 163,-	32224	3900,- 163,-	21600
koule / klika R	Kč €	2610,- 109,-	23505	2930,- 123,-	32187	2930,- 123,-	052039	3220,- 135,-	096682	4000,- 167,-	32231	4000,- 167,-	23543
koule / klika L	Kč €	2610,- 109,-	23512	2930,- 123,-	32194	2930,- 123,-	052046	3220,- 135,-	096699	4000,- 167,-	32248	4000,- 167,-	23550
dozické	Kč €	1540,- 65,-	21709	1710,- 72,-	21730	1710,- 72,-	052152	1880,- 79,-	096552	2950,- 123,-	32408	2950,- 123,-	32453
cylindrické	Kč €	1540,- 65,-	21716	1710,- 72,-	21747	1710,- 72,-	052169	1880,- 79,-	096569	2950,- 123,-	32415	2950,- 123,-	32460
WC	Kč €	2280,- 95,-	21723	2580,- 108,-	21754	2580,- 108,-	052176	2850,- 119,-	096576	3840,- 160,-	32422	3840,- 160,-	32477
koule / klika R	Kč €	2380,- 100,-	23802	2690,- 113,-	23826	2690,- 113,-	052183	2960,- 124,-	096583	3920,- 164,-	32439	3920,- 164,-	32484
koule / klika L	Kč €	2380,- 100,-	23819	2690,- 113,-	23833	2690,- 113,-	052190	2960,- 124,-	096590	3920,- 164,-	32446	3920,- 164,-	32491
dozické	Kč €	2260,- 95,-	66007	2560,- 107,-	66052	2560,- 107,-	052305	2800,- 117,-	096507	3490,- 146,-	66151	3490,- 146,-	66205
cylindrické	Kč €	2260,- 95,-	66014	2560,- 107,-	66069	2560,- 107,-	052312	2800,- 117,-	096514	3490,- 146,-	66168	3490,- 146,-	66212
WC	Kč €	3110,- 130,-	66021	3420,- 143,-	66076	3420,- 143,-	052329	3760,- 157,-	096521	4520,- 189,-	66175	4520,- 189,-	66229
koule / klika R	Kč €	3360,- 140,-	66038	3660,- 153,-	66083	3660,- 153,-	052336	4030,- 168,-	096538	4750,- 198,-	66182	4750,- 198,-	66236
koule / klika L	Kč €	3360,- 140,-	66045	3660,- 153,-	66090	3660,- 153,-	052343	4030,- 168,-	096545	4750,- 198,-	66199	4750,- 198,-	66243
rozeta zaslepovací	Kč €	320,- 14,-	63990	400,- 17,-	64003	560,- 24,-	052350	610,- 26,-	101737	620,- 26,-	64027	620,- 26,-	64034

V balení je standardně montážní materiál pro tl. dveří 38 - 45 mm. Pro větší tloušťky dveří je potřeba specifikovat jiný montážní materiál viz. Příslušenství a komponenty str. 376.



Ms mosaz natural



SNi matný nikel

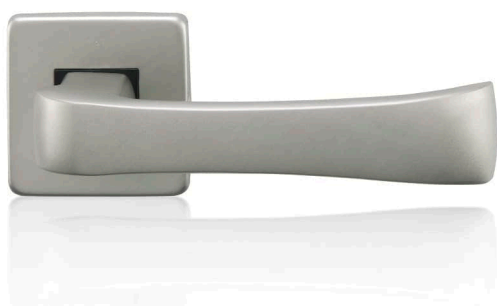

TIN-C titan chrom mat

**Entero madlo**  
s funkcí klika/klika

3380,- Kč  
141,- EUR

SNi - broušeno

**Entero**

2790,- Kč  
117,- EUR

**Lara**

2480,- Kč  
104,- EUR

**Sogut**

2380,- Kč  
100,- EUR

**Garanti**

1760,- Kč  
74,- EUR

**Kč** materiál: masivní mosaz  
povrch: SNi matný nikel **EUR**

3380,-  141,-

3380,-  141,-

4180,-  175,-

4430,-  185,-

4430,-  185,-

2790,-  117,-

2790,-  117,-

3630,-  152,-

3870,-  162,-

3870,-  162,-

2480,-  104,-

2480,-  104,-

3320,-  139,-

3580,-  150,-

3580,-  150,-

2380,-  100,-

2380,-  100,-

3220,-  135,-

3450,-  144,-

3450,-  144,-

1760,-  74,-

1760,-  74,-

2650,-  111,-

2880,-  120,-

2880,-  120,-



		SNI		SNI - broušeno		Cr		Ms		Ms-A		TiN-C		TiN-K	
		cena pár	EAN	cena pár	EAN	cena pár	EAN	cena pár	EAN	cena pár	EAN	cena pár	EAN	cena pár	EAN
dozické	Kč €			3380,- 141,-	68483	3680,- 154,-	68537	3680,- 154,-	052480	4040,- 169,-	096750	4600,- 192,-	68636	4600,- 192,-	68681
cyldrické	Kč €			3380,- 141,-	68490	3680,- 154,-	68544	3680,- 154,-	052497	4040,- 169,-	096767	4600,- 192,-	68643	4600,- 192,-	68698
WC	Kč €			4180,- 175,-	68506	4520,- 189,-	68551	4520,- 189,-	052503	4970,- 208,-	096774	5590,- 233,-	68650	5590,- 233,-	68704
pevné / otočné R	Kč €			4430,- 185,-	68513	4750,- 198,-	68568	4750,- 198,-	052510	5220,- 218,-	096781	5830,- 243,-	68667	5830,- 243,-	68711
pevné / otočné L	Kč €			4430,- 185,-	68520	4750,- 198,-	68575	4750,- 198,-	052527	5220,- 218,-	096798	5830,- 243,-	68674	5830,- 243,-	68728
dozické	Kč €	2790,- 117,-	087239	2910,- 122,-	66304	3210,- 134,-	66359	3210,- 134,-	052633	3520,- 147,-	096705	4140,- 173,-	66458	4140,- 173,-	66502
cyldrické	Kč €	2790,- 117,-	087246	2910,- 122,-	66311	3210,- 134,-	66366	3210,- 134,-	052640	3520,- 147,-	096712	4140,- 173,-	66465	4140,- 173,-	66519
WC	Kč €	3630,- 152,-	087253	3720,- 155,-	66328	4050,- 169,-	66373	4050,- 169,-	052657	4450,- 186,-	096729	5120,- 214,-	66472	5120,- 214,-	66526
madlo / klika R	Kč €	3870,- 162,-	087260	3960,- 165,-	66335	4280,- 179,-	66380	4280,- 179,-	052664	4710,- 197,-	096736	5370,- 224,-	66489	5370,- 224,-	66533
madlo / klika L	Kč €	3870,- 162,-	087277	3960,- 165,-	66342	4280,- 179,-	66397	4280,- 179,-	052671	4710,- 197,-	096743	5370,- 224,-	66496	5370,- 224,-	66540
dozické	Kč €	2480,- 104,-	087185	2570,- 108,-	66601	2880,- 120,-	66656	2880,- 120,-	052787	3170,- 133,-	096859	3820,- 160,-	66755	3820,- 160,-	66809
cyldrické	Kč €	2480,- 104,-	087192	2570,- 108,-	66618	2880,- 120,-	66663	2880,- 120,-	052794	3170,- 133,-	096866	3820,- 160,-	66762	3820,- 160,-	66816
WC	Kč €	3320,- 139,-	087208	3420,- 143,-	66625	3720,- 155,-	66670	3720,- 155,-	052800	4100,- 171,-	096873	4810,- 201,-	66779	4810,- 201,-	66823
madlo / klika R	Kč €	3580,- 150,-	087215	3660,- 153,-	66632	3960,- 165,-	66687	3960,- 165,-	052817	4360,- 182,-	096880	5060,- 211,-	66786	5060,- 211,-	66830
madlo / klika L	Kč €	3580,- 150,-	087222	3660,- 153,-	66649	3960,- 165,-	66694	3960,- 165,-	052824	4360,- 182,-	096897	5060,- 211,-	66793	5060,- 211,-	66847
dozické	Kč €	2380,- 100,-	67820			2690,- 113,-	67875	2690,- 113,-	052930	2960,- 124,-	096903	3620,- 151,-	67974	3620,- 151,-	68025
cyldrické	Kč €	2380,- 100,-	67837			2690,- 113,-	67882	2690,- 113,-	052947	2960,- 124,-	096910	3620,- 151,-	67981	3620,- 151,-	68032
WC	Kč €	3220,- 135,-	67844			3520,- 147,-	67899	3520,- 147,-	052954	3870,- 162,-	096927	4620,- 193,-	67998	4620,- 193,-	68049
madlo / klika R	Kč €	3450,- 144,-	67851			3760,- 157,-	67905	3760,- 157,-	052961	4140,- 173,-	096934	4850,- 203,-	68001	4850,- 203,-	68056
madlo / klika L	Kč €	3450,- 144,-	67868			3760,- 157,-	67912	3760,- 157,-	052978	4140,- 173,-	096941	4850,- 203,-	68018	4850,- 203,-	68063
dozické	Kč €	1760,- 74,-	66922			2080,- 87,-	66977	2080,- 87,-	053081	2280,- 95,-	096804	3010,- 126,-	67073	3010,- 126,-	67127
cyldrické	Kč €	1760,- 74,-	66939			2080,- 87,-	66984	2080,- 87,-	053098	2280,- 95,-	096811	3010,- 126,-	67080	3010,- 126,-	67134
WC	Kč €	2650,- 111,-	66946			2960,- 124,-	66991	2960,- 124,-	053104	3240,- 135,-	096828	4050,- 169,-	67097	4050,- 169,-	67141
madlo / klika R	Kč €	2880,- 120,-	66953			3200,- 134,-	67004	3200,- 134,-	053111	3510,- 147,-	096835	4280,- 179,-	67103	4280,- 179,-	67158
madlo / klika L	Kč €	2880,- 120,-	66960			3200,- 134,-	67011	3200,- 134,-	053128	3510,- 147,-	096842	4280,- 179,-	67110	4280,- 179,-	67165

U kombinace madlo / klika dodáváme standardně madlo Entero pevné - neotočné. Na základě požadavku madlo Entero otočné s funkcí kliky.

V balení je standardně montážní materiál pro tl. dveří 38 - 45 mm. Pro větší tloušťky dveří je potřeba specifikovat jiný montážní materiál viz. Příslušenství a komponenty str. 376.



SNi matný nikel

**Lusy**

1940,- Kč  
81,- EUR



TIN-K titan černý mat

**Deny**

1940,- Kč  
81,- EUR



**Cherez**

2740,- Kč  
115,- EUR



**Mondeo**

2420,- Kč  
101,- EUR

Kč	materiál: masivní mosaz povrch: SNi matný nikel			EUR
1940,-				81,-
1940,-				81,-
2790,-				117,-
3030,-				127,-
3030,-				127,-
1940,-				81,-
1940,-				81,-
2790,-				117,-
3030,-				127,-
3030,-				127,-
2740,-				115,-
2740,-				115,-
3590,-				150,-
3820,-				160,-
3820,-				160,-
2420,-				101,-
2420,-				101,-
3260,-				136,-
3500,-				146,-
3500,-				146,-
400,-				17,-



		SNI		Cr		Ms		Ms-A		TiN-C		TiN-K	
		cena pár	EAN	cena pár	EAN	cena pár	EAN	cena pár	EAN	cena pár	EAN	cena pár	EAN
dozické	Kč €	1940,- 81,-	67226	2260,- 95,-	67271	2260,- 95,-	053234	2470,- 103,-	097054	3190,- 133,-	67370	3190,- 133,-	67424
cyldrické	Kč €	1940,- 81,-	67233	2260,- 95,-	67288	2260,- 95,-	053241	2470,- 103,-	097061	3190,- 133,-	67387	3190,- 133,-	67431
WC	Kč €	2790,- 117,-	67240	3110,- 130,-	67295	3110,- 130,-	053258	3420,- 143,-	097078	4180,- 175,-	67394	4180,- 175,-	67448
madlo / klika R	Kč €	3030,- 127,-	67257	3360,- 140,-	67301	3360,- 140,-	053265	3690,- 154,-	097085	4430,- 185,-	67400	4430,- 185,-	67455
madlo / klika L	Kč €	3030,- 127,-	67264	3360,- 140,-	67318	3360,- 140,-	053272	3690,- 154,-	097092	4430,- 185,-	67417	4430,- 185,-	67462
dozické	Kč €	1940,- 81,-	67523	2260,- 95,-	67578	2260,- 95,-	053388	2470,- 103,-	096958	3190,- 133,-	67677	3190,- 133,-	67721
cyldrické	Kč €	1940,- 81,-	67530	2260,- 95,-	67585	2260,- 95,-	053395	2470,- 103,-	096965	3190,- 133,-	67684	3190,- 133,-	67738
WC	Kč €	2790,- 117,-	67547	3110,- 130,-	67592	3110,- 130,-	053401	3420,- 143,-	096972	4180,- 175,-	67691	4180,- 175,-	67745
madlo / klika R	Kč €	3030,- 127,-	67554	3360,- 140,-	67608	3360,- 140,-	053418	3690,- 154,-	096989	4430,- 185,-	67707	4430,- 185,-	67752
madlo / klika L	Kč €	3030,- 127,-	67561	3360,- 140,-	67615	3360,- 140,-	053425	3690,- 154,-	096996	4430,- 185,-	67714	4430,- 185,-	67769
dozické	Kč €	2740,- 115,-	78413	3030,- 127,-	78468	3030,- 127,-	053531	3330,- 139,-	097009	3960,- 165,-	78567	3960,- 165,-	78611
cyldrické	Kč €	2740,- 115,-	78420	3030,- 127,-	78475	3030,- 127,-	053548	3330,- 139,-	097016	3960,- 165,-	78574	3960,- 165,-	78628
WC	Kč €	3590,- 150,-	78437	3890,- 163,-	78482	3890,- 163,-	053555	4270,- 178,-	097023	4980,- 208,-	78581	4980,- 208,-	78635
madlo / klika R	Kč €	3820,- 160,-	78444	4130,- 173,-	78499	4130,- 173,-	053562	4540,- 190,-	097030	5210,- 218,-	78598	5210,- 218,-	78642
madlo / klika L	Kč €	3820,- 160,-	78451	4130,- 173,-	78505	4130,- 173,-	053579	4540,- 190,-	097047	5210,- 218,-	78604	5210,- 218,-	78659
dozické	Kč €	2420,- 101,-	74453	2740,- 115,-	74507	2740,- 115,-	053685	3000,- 125,-	097108	3660,- 153,-	74606	3660,- 153,-	74651
cyldrické	Kč €	2420,- 101,-	74460	2740,- 115,-	74514	2740,- 115,-	053692	3000,- 125,-	097115	3660,- 153,-	74613	3660,- 153,-	74668
WC	Kč €	3260,- 136,-	74477	3590,- 150,-	74521	3590,- 150,-	053708	3940,- 165,-	097122	4650,- 194,-	74620	4650,- 194,-	74675
madlo / klika R	Kč €	3500,- 146,-	74484	3820,- 160,-	74538	3820,- 160,-	053715	4200,- 175,-	097139	4900,- 205,-	74637	4900,- 205,-	74682
madlo / klika L	Kč €	3500,- 146,-	74491	3820,- 160,-	74545	3820,- 160,-	053722	4200,- 175,-	097146	4900,- 205,-	74644	4900,- 205,-	74699
rozeta zaslepovací	Kč €	400,- 17,-	72381	490,- 21,-	72398	720,- 30,-	055337	790,- 33,-	101744	790,- 33,-	72411	790,- 33,-	72428

V balení je standardně montážní materiál pro tl. dveří 38 - 45 mm. Pro větší tloušťky dveří je potřeba specifikovat jiný montážní materiál viz. Příslušenství a komponenty str. 376.



Celý projekt - jeden design

Dveřní kliky DESIGN 2006



Kování pro hliníkové a ocelové dveře,  
kování na branky



Kliky a zámky na skleněné dveře



Madla a koule na skleněné  
a dřevěné dveře



Panty na skleněné dveře



Bezpečnostní rozety



Mušle na posuvné  
dveře



Panty na dřevěné dveře



Okenní kliky  
3 a 4 polohové



Bezpečnostní madla  
Entero



Madla dlouhá





## Dveřní kliky DESIGN 2006

Materiál: masivní mosaz

Povrchy: SNI, SNI - broušeno, Cr, TiN-C, TiN-K, Ms, Ms-L  
více info na [www.kliky-mt.cz/manufaktura/barvy-povrchy](http://www.kliky-mt.cz/manufaktura/barvy-povrchy)

Kování představené v roce 2006 na mezinárodním veletrhu Practical World v Kolíně nad Rýnem se ihned stalo ikonou v tomto segmentu. Kliky řady DESIGN 2006 se vyznačují nezaměnitelným designem s citlivě vyváženou proporcí mezi klikou a rozetou. U této kolekce je poprvé použit systém tlačných pružin v zapouzdřené vnitřní konstrukci rozet, které vynikají svoji stabilitou při přenosu zatížení mezi klikou a zámkem a zároveň velmi tichým chodem. Nadčasovost klik M&T je zřejmá i na mnoha kopiích od mnoha výrobců z různých částí světa, které i po 15 letech od uvedení na trh neustále vznikají a zaplavují trh jako další novinky ☺.

**ENTRY TiN-K** titan černý mat

**TRINITY TiN-C** titan chrom mat

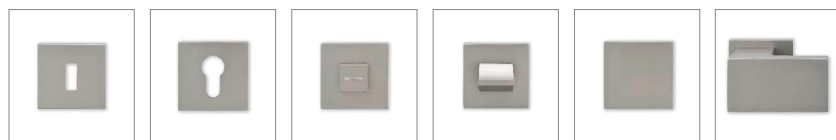
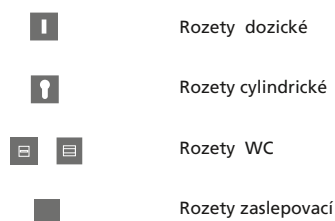
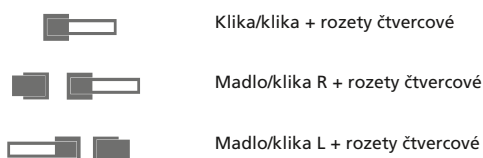
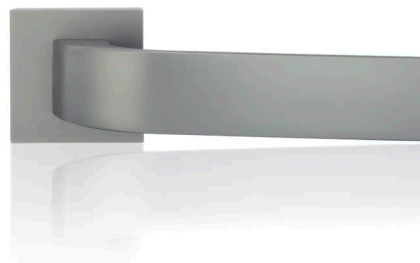
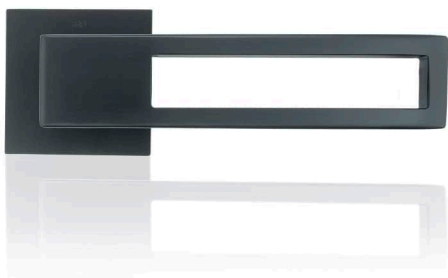

dozické    cylindrické    WC ex    WC in    zaslepovací    madlo Entry

rozety 54x54 mm

konstrukční varianty, materiálové provedení

- designová sada standardně bez spodních rozet
- spodní rozety se objednávají samostatně
- konstrukční systém 4 tlačných pružin u kliky
- velmi tichý chod
- montáž sešroubování pouzdry proti sobě
- další fixace pomocí 4 vrtů
- rukojeti vyrobeny z masivní mosazi
- rozety vyrobeny z masivní mosazi
- zajišťovací gel proti uvolnění šroubů
- vrtání PROFÍ šablonou M&T vrtákem Ø 6,4 mm
- animace montáže na [www.kliky-mt.cz/montaze-kovani](http://www.kliky-mt.cz/montaze-kovani)
- montáž pro tloušťky dveří 38 – 126 mm
- v balení standardně montážní materiál pro tl. dveří 38 - 45 mm
- záruka 3 roky, titany 15 let, mosaz doživotní

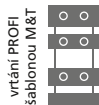

Ochranná známka – registrovaná značka

**ENTERO®**



Chráněné průmyslové vzory klik



**ENTERO**  
**ENTRY**  
**TRINITY**  
**MY**  
**TERRY**

roky **3 garance** let **15 garance**

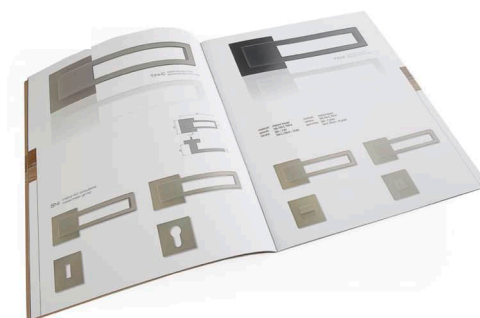



SNi matný nikel



TiN-C titan chrom mat



SNi matný nikel



TiN-K titan černý mat



SNi matný nikel



**Entry**

2590,- Kč  
150,- EUR

**Trinity**

3110,- Kč  
130,- EUR

**My**

3260,- Kč  
136,- EUR

**Terry**

3260,- Kč  
136,- EUR

**Entero**

3590,- Kč  
150,- EUR

**Rozety** 54x54 mm

930,- Kč  
39,- EUR

Kč materiál: masivní mosaz povrch: SNi matný nikel EUR

3590,- 150,-

4650,- 194,-

4650,- 194,-

3110,- 130,-

4180,- 175,-

4180,- 175,-

3260,- 136,-

4350,- 182,-

4350,- 182,-

3260,- 136,-

4350,- 182,-

4350,- 182,-

3590,- 150,-

4650,- 194,-

4650,- 194,-

930,- 39,-

930,- 39,-

1090,- 46,-

1860,- 78,-



		Sni		Sni - broušeno		Cr		Ms		TiN-C		TiN-K	
		cena	EAN	cena	EAN	cena	EAN	cena	EAN	cena	EAN	cena	EAN
		pár		pár		pár		pár		pár		pár	
klika / klika	Kč €	3590,- 150,-	91405	3680,- 154,-	78710	3890,- 163,-	78741	3890,- 163,-	053838	4810,- 201,-	78802	4810,- 201,-	78833
madlo / klika R	Kč €	4650,- 194,-	91412	4760,- 199,-	78727	4980,- 208,-	78758	4980,- 208,-	053845	6050,- 253,-	78819	6050,- 253,-	78857
madlo / klika L	Kč €	4650,- 194,-	91429	4760,- 199,-	78734	4980,- 208,-	78765	4980,- 208,-	053852	6050,- 253,-	78826	6050,- 253,-	78871
klika / klika	Kč €	3110,- 130,-	91436	3210,- 134,-	78895	3420,- 143,-	78925	3420,- 143,-	053890	4350,- 182,-	78987	4350,- 182,-	79014
madlo / klika R	Kč €	4180,- 175,-	91443	4310,- 180,-	78901	4520,- 189,-	78932	4520,- 189,-	053906	5440,- 227,-	78994	5440,- 227,-	79038
madlo / klika L	Kč €	4180,- 175,-	91450	4310,- 180,-	78918	4520,- 189,-	78949	4520,- 189,-	053913	5440,- 227,-	79007	5440,- 227,-	79052
klika / klika	Kč €	3260,- 136,-	91467	3380,- 141,-	79076	3590,- 150,-	79106	3590,- 150,-	053951	4520,- 189,-	79168	4520,- 189,-	79199
madlo / klika R	Kč €	4350,- 182,-	91474	4440,- 185,-	79083	4650,- 194,-	79113	4650,- 194,-	053968	5590,- 233,-	79175	5590,- 233,-	79212
madlo / klika L	Kč €	4350,- 182,-	91481	4440,- 185,-	79090	4650,- 194,-	79120	4650,- 194,-	053975	5590,- 233,-	79182	5590,- 233,-	79236
klika / klika	Kč €	3260,- 136,-	91498	3380,- 141,-	79250	3590,- 150,-	79281	3590,- 150,-	054019	4520,- 189,-	79342	4520,- 189,-	79373
madlo / klika R	Kč €	4350,- 182,-	91504	4440,- 185,-	79267	4650,- 194,-	79298	4650,- 194,-	054026	5590,- 233,-	79359	5590,- 233,-	79397
madlo / klika L	Kč €	4350,- 182,-	91511	4440,- 185,-	79274	4650,- 194,-	79304	4650,- 194,-	054033	5590,- 233,-	79366	5590,- 233,-	79410
klika / klika	Kč €	3590,- 150,-	91528	3680,- 154,-	90910	3890,- 163,-	91030	3890,- 163,-	054071	4810,- 201,-	90958	4810,- 201,-	90996
madlo / klika R	Kč €	4650,- 194,-	91535	4760,- 199,-	90927	4980,- 208,-	91047	4980,- 208,-	054088	6050,- 253,-	90965	6050,- 253,-	91009
madlo / klika L	Kč €	4650,- 194,-	91542	4760,- 199,-	90934	4980,- 208,-	91054	4980,- 208,-	054095	6050,- 253,-	90972	6050,- 253,-	91016
dozické	Kč €	930,- 39,-	91559	990,- 42,-	79465	1090,- 46,-	79502	1090,- 46,-	054132	1400,- 59,-	79526	1400,- 59,-	79533
cyldrické	Kč €	930,- 39,-	91566	990,- 42,-	79434	1090,- 46,-	79441	1090,- 46,-	054149	1400,- 59,-	68414	1400,- 59,-	79472
zaslepovací	Kč €	1090,- 46,-	91573	1140,- 48,-	83516	1250,- 53,-	83523	1250,- 53,-	054156	1550,- 65,-	83547	1550,- 65,-	83554
WC	Kč €	1860,- 78,-	91580	1930,- 81,-	79557	2030,- 85,-	79564	2030,- 85,-	054163	2330,- 98,-	79588	2330,- 98,-	79595

U kombinace madlo / klika dodáváme standardně madlo Entry pevné - neotočné.

V balení je standardně montážní materiál pro tl. dveří 38 - 45 mm. Pro větší tloušťky dveří je potřeba specifikovat jiný montážní materiál viz. Příslušenství a komponenty str. 376.



Celý projekt - jeden design

Dveřní kliky DESIGN 2009



Dveřní zarážky



Madla a koule na skleněné a dřevěné dveře



Panty na dřevěné dveře



Okenní kliky 3 a 4 polohové



Okenní kliky HS Portaly na posuvná okna a stěny



Madla dlouhá



Kliky a zámky na skleněné dveře



Panty na skleněné dveře



Mušle na posuvné dveře



Bezpečnostní rozety



Kování pro hliníkové a ocelové dveře, kování na branky



## Dveřní kliky DESIGN 2009

Materiál: masivní mosaz

Povrchy: SNI, SNI - broušeno, Cr, TiN-C, TiN-K, TiN-B, Ms, Ms-L  
více info na [www.kliky-mt.cz/manufaktura/barvy-povrchy](http://www.kliky-mt.cz/manufaktura/barvy-povrchy)

Kování uvedené na trh v roce 2009 představuje neustálou designovou a materiálovou inovaci ve společnosti M&T. Povrchy a materiály použité v této kolekci tj. povrch TiN-B titan braun mat, kombinace masivní dřeva + kov, použití materiálu Alu kompakt, jsou i nyní na úplném vrcholu současného designu. Řada kování Mimolimit s mnoha doplňky si opakovaně nachází svoje uplatnění v těch nejprestižnějších projektech na známých adresách v různých částech světa. Konstrukčně je využit systém tlačných pružin v zapouzdřené vnitřní konstrukci rozet, které vynikají svoji stabilitou při přenosu zatížení mezi klikou a zámekem a zároveň velmi tichým chodem.

**TORO TiN-B** titan braun mat

**MIMOLIMIT TiN-K** titan černý mat + dřevina masivní ořech

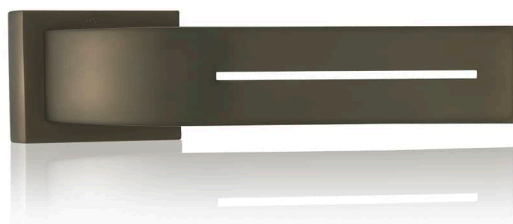

- Klika/klika + rozety obdélníkové
- Madlo/klika R + rozety obdélníkové
- Madlo/klika L + rozety obdélníkové
- Spodní rozety dozické
- Spodní rozety cylindrické
- Spodní rozety WC
- Spodní rozety zaslepovací

- Klika/klika + rozety čtvercové
- Madlo/klika R + rozety čtvercové
- Madlo/klika L + rozety čtvercové
- Spodní rozety dozické
- Spodní rozety cylindrické
- Spodní rozety WC
- Spodní rozety zaslepovací



dozické    cylindrické    WC ex Toro    WC in Toro    madlo Toro

rozety 60x47 mm

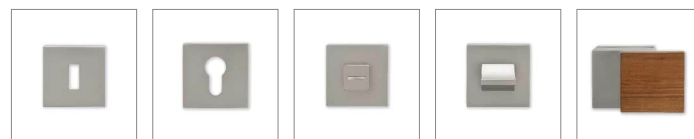

dozické    cylindrické    WC ex    WC in    madlo Mimolimit

rozety 54x54 mm

konstrukční varianty, materiálové provedení

- designová sada standardně bez spodních rozet
- spodní rozety 60x47 mm se objednávají samostatně
- u řady klik Mimolimit použity rozety 54x54 mm
- madla vždy v designu podle kliky z vnitřní strany dveří
- konstrukční systém 4 tlačných pružin u kliky
- velmi tichý chod
- montáž sešroubování pouzdry proti sobě
- další fixace pomocí 4 vrtutí
- rukojeti vyrobeny z masivní mosazi
- rozety vyrobeny z masivní mosazi
- vrtání PROFI šablonou M&T vrtákem Ø 6,4 mm
- animace montáže na [www.kliky-mt.cz/montaze-kovani](http://www.kliky-mt.cz/montaze-kovani)
- montáž pro tloušťky dveří 38 – 126 mm
- záruka 3 roky, titany 15 let, mosaz doživotní

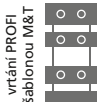

zaslepovací

Ochranná známka – registrovaná značka

**MIMOLIMIT®**



Chráněné průmyslové vzory klik



**TORO  
MAYA  
TUKAN  
MIMOLIMIT**

madla

**MIMOLIMIT**

3 roky garance    15 let garance

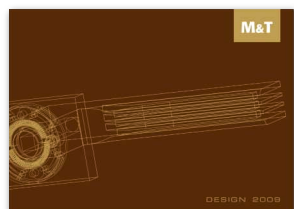

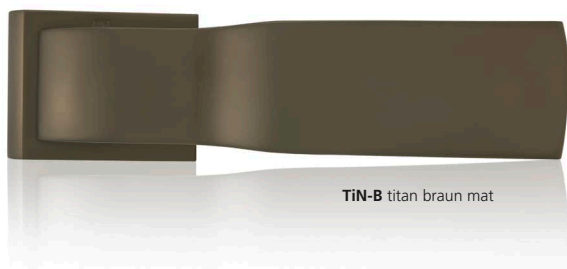

TIN-B titan braun mat

**Tukan**

3890,- Kč  
163,- EUR



SNi matný nikl

**Maya**

4180,- Kč  
175,- EUR

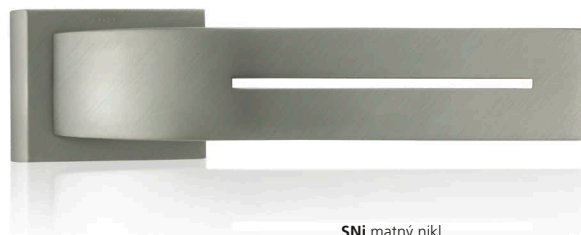

SNi matný nikl

**Toro**

3890,- Kč  
163,- EUR



**Rozety** 60x47 mm

930,- Kč  
39,- EUR



materiál: masivní mosaz  
Kč povrch: SNi matný nikl - broušeno EUR

3890,- 163,-

5120,- 214,-

5120,- 214,-

4180,- 175,-

5440,- 227,-

5440,- 227,-

3890,- 163,-

5120,- 214,-

5120,- 214,-

930,- 39,-

930,- 39,-

930,- 39,-

930,- 39,-

2030,- 85,-

2030,- 85,-

2030,- 85,-

2030,- 85,-

1250,- 53,-

1250,- 53,-



		SNI - broušeno		Cr		Ms		TiN-C		TiN-B	
		cena	EAN	cena	EAN	cena	EAN	cena	EAN	cena	EAN
		pár		pár		pár		pár		pár	
klika / klika	Kč €	3890,- 163,-	85213	4180,- 175,-	022032	4180,- 175,-	054217	5120,- 214,-	85268	5120,- 214,-	85312
madlo / klika R	Kč €	5120,- 214,-	85244	5440,- 227,-	022049	5440,- 227,-	054224	6520,- 272,-	85299	6520,- 272,-	85343
madlo / klika L	Kč €	5120,- 214,-	85251	5440,- 227,-	022056	5440,- 227,-	054231	6520,- 272,-	85305	6520,- 272,-	85350
klika / klika	Kč €	4180,- 175,-	85367	4520,- 189,-	022070	4520,- 189,-	054279	5440,- 227,-	85411	5440,- 227,-	85466
madlo / klika R	Kč €	5440,- 227,-	85398	5740,- 240,-	022087	5740,- 240,-	054286	6830,- 285,-	85442	6830,- 285,-	85497
madlo / klika L	Kč €	5440,- 227,-	85404	5740,- 240,-	022094	5740,- 240,-	054293	6830,- 285,-	85459	6830,- 285,-	85503
klika / klika	Kč €	3890,- 163,-	85510	4180,- 175,-	022117	4180,- 175,-	054330	5120,- 214,-	85565	5120,- 214,-	85619
madlo / klika R	Kč €	5120,- 214,-	85541	5440,- 227,-	022124	5440,- 227,-	054347	6520,- 272,-	85596	6520,- 272,-	85640
madlo / klika L	Kč €	5120,- 214,-	85558	5440,- 227,-	022131	5440,- 227,-	054354	6520,- 272,-	85602	6520,- 272,-	85657
dozické Maya	Kč €	930,- 39,-	85930	1090,- 46,-	022261	1090,- 46,-	054392	1400,- 59,-	85992	1400,- 59,-	86050
dozické Toro / Tukan	Kč €	930,- 39,-	86111	1090,- 46,-	022278	1090,- 46,-	054408	1400,- 59,-	86128	1400,- 59,-	86135
cylindrické Maya	Kč €	930,- 39,-	85947	1090,- 46,-	022285	1090,- 46,-	054415	1400,- 59,-	86005	1400,- 59,-	86067
cylindrické Toro / Tukan	Kč €	930,- 39,-	86142	1090,- 46,-	022292	1090,- 46,-	054422	1400,- 59,-	86159	1400,- 59,-	86166
WC Maya R	Kč €	2030,- 85,-	85954	2180,- 91,-	022308	2180,- 91,-	054439	2490,- 104,-	86012	2490,- 104,-	86074
WC Maya L	Kč €	2030,- 85,-	85961	2180,- 91,-	022315	2180,- 91,-	054446	2490,- 104,-	86029	2490,- 104,-	86081
WC Toro / Tukan R	Kč €	2030,- 85,-	85978	2180,- 91,-	022322	2180,- 91,-	054453	2490,- 104,-	86036	2490,- 104,-	86098
WC Toro / Tukan L	Kč €	2030,- 85,-	85985	2180,- 91,-	022339	2180,- 91,-	054460	2490,- 104,-	86043	2490,- 104,-	86104
zaslepovací Toro / Tukan	Kč €	1250,- 53,-	021998	1340,- 56,-	022001	1340,- 56,-	054477	1720,- 72,-	022018	1720,- 72,-	022025
zaslepovací Maya	Kč €	1250,- 53,-	020670	1340,- 56,-	020687	1340,- 56,-	054484	1720,- 72,-	020694	1720,- 72,-	020700

U kombinace madlo / klika dodáváme standardně madla pevná - neotočná.

V balení je standardně montážní materiál pro tl. dveří 39 - 45 mm. Pro jiné tloušťky dveří je potřeba specifikovat přesnou tloušťku dveří.



TiN-B titan braun mat + dub

**Mimolimit**

3800,- Kč  
159,- EUR



Alu kompakt



**Destičky Mimolimit**

1600,- Kč  
67,- EUR



SNi matný nikl + ořech

**Madlo Mimolimit**

4310,- Kč  
180,- EUR



SNi matný nikl + teak

**Madlo Mimolimit**

4470,- Kč  
187,- EUR

**Kč** materiál: masivní mosaz povrch: SNi matný nikl **EUR**

3800,- 159,-



5020,- 210,-



5020,- 210,-



**Kč** materiál: masivní dřevo povrch: olejováno **EUR**

1600,- 67,-

810,- 34,-

810,- 34,-

900,- 38,-

980,- 41,-

810,- 34,-



**Kč** materiál: masivní mosaz povrch: SNi matný nikl broušeno **EUR**

4310,- 180,-

5150,- 215,-

7560,- 315,-

8550,- 357,-

11260,- 470,-

14140,- 590,-



**Kč** materiál: masivní mosaz povrch: SNi matný nikl broušeno **EUR**

4470,- 187,-



4630,- 193,-

4790,- 200,-

4790,- 200,-





		SNI		SNI - broušeno		Cr		Ms		TiN-C		TiN-K		TiN-B	
		cena	EAN	cena	EAN	cena	EAN	cena	EAN	cena	EAN	cena	EAN	cena	EAN
		pár		pár		pár		pár		pár		pár		pár	
klika / klika	Kč €	3800,- 159,-	087284	3890,- 163,-	85664	4180,- 175,-	022155	4180,- 175,-	054590	5120,- 214,-	85725	5120,- 214,-	85787	5120,- 214,-	85848
madlo / klika R	Kč €	5020,- 210,-	087291	5120,- 214,-	85695	5440,- 227,-	022162	5440,- 227,-	054606	6520,- 272,-	85756	6520,- 272,-	85817	6520,- 272,-	85879
madlo / klika L	Kč €	5020,- 210,-	087307	5120,- 214,-	85701	5440,- 227,-	022179	5440,- 227,-	054613	6520,- 272,-	85763	6520,- 272,-	85824	6520,- 272,-	85886

V balení je standardně montážní materiál pro tl. dveří 38 - 45 mm. Pro větší tloušťky dveří je potřeba specifikovat jiný montážní materiál viz. Příslušenství a komponenty str. 376.

		cena	EAN
		pár	
Alu kompak	Kč €	1600,- 67,-	83899
ořech	Kč €	810,- 34,-	83851
jilm	Kč €	810,- 34,-	83868
bělený dub	Kč €	900,- 38,-	83875
teak	Kč €	980,- 41,-	83844
dub	Kč €	810,- 34,-	83882



Rozety 54x54 mm		TiN-B	
		cena	EAN
		pár	
dozické	Kč €	1400,- 59,-	043099
cyklindrické	Kč €	1400,- 59,-	043105
zaslepovací	Kč €	1550,- 65,-	043112
WC	Kč €	2330,- 98,-	043129

zakázkově lze rukojeť dodat v dalších dřevinách



ostatní povrchy rozet na str. 91

rozteč / celk. délka		SNI - broušeno		Cr		Ms		TiN-C		TiN-K		TiN-B	
		cena	EAN	cena	EAN	cena	EAN	cena	EAN	cena	EAN	cena	EAN
		ks		ks		ks		ks		ks		ks	
300 / 340 mm	Kč €	4310,- 180,-	83301	4440,- 185,-	022209	4440,- 185,-	058895	5840,- 244,-	83349	6310,- 263,-	83363	6310,- 263,-	83387
600 / 640 mm	Kč €	5150,- 215,-	83318	5290,- 221,-	022216	5290,- 221,-	058901	6690,- 279,-	83356	7160,- 299,-	83370	7160,- 299,-	83394
900 / 940 mm	Kč €	7560,- 315,-	83974	7700,- 321,-	022223	7700,- 321,-	058918	9400,- 392,-	84018	9870,- 412,-	84056	9870,- 412,-	84094
1200 / 1240 mm	Kč €	8550,- 357,-	83981	8710,- 363,-	022230	8710,- 363,-	058925	10100,- 421,-	84025	10560,- 440,-	84063	10560,- 440,-	84100
1800 / 1840 mm	Kč €	11260,- 470,-	83998	11430,- 477,-	022247	11430,- 477,-	058932	13590,- 567,-	84032	14060,- 586,-	84070	14060,- 586,-	84117
2400 / 2440 mm	Kč €	14140,- 590,-	84001	14280,- 595,-	022254	14280,- 595,-	058949	17070,- 712,-	84049	17540,- 731,-	84087	17540,- 731,-	84124

Uváděné ceny pouze za kovovou část madla. Kompletní ceny za dřevěnou část + montážní materiál jsou uvedeny na str. 216 - 217 Madla dlouhá.

		SNI - broušeno	
		cena / pár	EAN
tloušťka dveří 37 - 50 mm	Kč €	4470,- 187,-	32040
tloušťka dveří 51 - 68 mm	Kč €	4630,- 193,-	32057
tloušťka dveří 69 - 85 mm	Kč €	4790,- 200,-	32064
tloušťka dveří 8 - 12 mm sklo	Kč €	4790,- 200,-	32071

Další možnosti povrchů madel na str. 331.

Destičky k madlu 54x54 mm		cena	EAN
		ks	
Alu kompak	Kč €	500,- 21,-	101997
ořech	Kč €	420,- 18,-	102000
jilm	Kč €	420,- 18,-	102017
bělený dub	Kč €	420,- 18,-	101423
teak	Kč €	450,- 19,-	102024
dub	Kč €	420,- 18,-	102031







Celý projekt - jeden design

Dveřní kliky DESIGN 2011 řada MINI



Kliky a zámky na skleněné dveře



Bezpečnostní rozety



Panty na skleněné dveře



Panty na dřevěné dveře



Mušle na posuvné dveře



Okenní kliky 3 a 4 polohové



## Dveřní kliky DESIGN 2011 řada MINI

Materiál: masivní mosaz

Povrchy: **SNi, Cr, TiN-K, Ms, Ms-L**  
více info na [www.kliky-mt.cz/manufaktura/barvy-povrchy](http://www.kliky-mt.cz/manufaktura/barvy-povrchy)

Kování uvedené na trh v roce 2011 reaguje na požadavky zákazníků s oblibou v minimalistickém pojetí interiérů, kdy díky nové konstrukci mini rozet dochází k minimalizaci celého vzhledu této řady dveřních klik. Budete překvapeni perfektní funkcí mini rozet a celého kování řady MINI.

### MINI-V **SNi** matný nikl



- Kliku/klika + rozety mini
- Rozety mini dozické
- Rozety mini WC
- Rozety mini zaslepovací



dozické zaslepovací WC in WC ex

rozety 47x33 mm

#### konstrukční varianty, materiálové provedení

- designová sada standardně bez spodních rozet
- spodní rozety se objednávají samostatně
- 2 varianty rozet tj. mini, nebo čtvercové 47x47 mm
- konstrukční systém 4 tlačných pružin u kliky
- velmi tichý chod
- montáž sešroubování pouzdry proti sobě
- další fixace pomocí 8 vrtů
- rukojeti vyrobeny z masivní mosazi
- rozety vyrobeny z masivní mosazi
- vrtání PROFI šablonou M&T vrtákem Ø 6,4 mm
- animace montáže na [www.kliky-mt.cz/montaze-kovani](http://www.kliky-mt.cz/montaze-kovani)
- montáž pro tloušťky dveří 38 – 126 mm
- možnost dodání v protipožárním provedení
- v balení standardně montážní materiál pro tl. dveří 38 - 45 mm
- záruka 3 roky, titany 15 let, mosaz natural doživotní

vrtání PROFI  
šablonou M&T

roky **3 garance** let **15 garance**

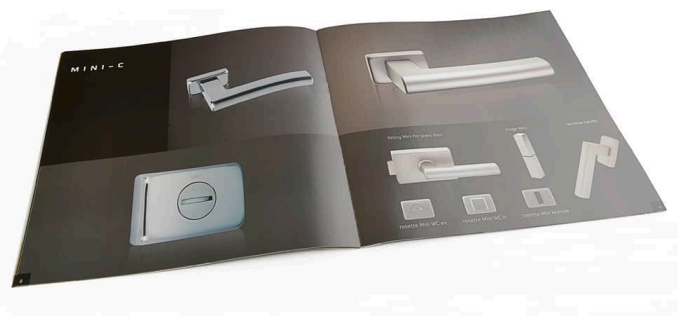

Více informací o produktech DESIGN 2011 MINI v tištěném katalogu DESIGN 2011 MINI, nebo na [www.kliky-mt.cz/katalog](http://www.kliky-mt.cz/katalog)

### MINI-T **TiN-K** titan černý mat

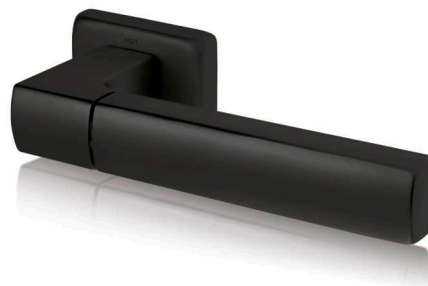

- Kliku/klika + rozety čtvercové
- Madlo/klika R + rozety čtvercové
- Madlo/klika L + rozety čtvercové
- Rozety čtvercové dozické
- Rozety čtvercové cylindrické
- Rozety čtvercové WC
- Rozety čtvercové zaslepovací



dozické cylindrické WC in WC ex zaslepovací

rozety 47x47 mm

Ochranná známka – registrovaná značka

**MINI®**



madlo Minimal

Chráněné průmyslové vzory klik



**MINI-V**  
**MINI-C**  
**MINI-S**  
**MINI-T**



SNi matný nikl

**Mini-V**

2180,- Kč  
91,- EUR



**Mini-C**

2030,- Kč  
85,- EUR



TiN-K titan černý mat

**Mini-S**

2030,- Kč  
85,- EUR

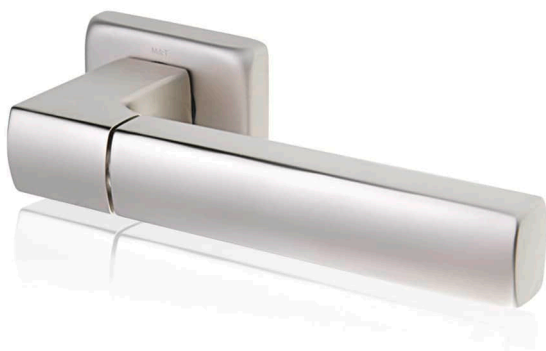

**Mini-T**

2030,- Kč  
85,- EUR



**Rozety Mini**

620,- Kč  
26,- EUR



**Rozety čtvercové 47x47 mm**

1090,- Kč  
46,- EUR



materiál: masivní mosaz  
povrch: SNi matný nikl

**Kč** **EUR**

2180,- 91,-

2790,- 117,-

3110,- 130,-

3110,- 130,-

2030,- 85,-

2650,- 111,-

2960,- 124,-

2960,- 124,-

2030,- 85,-

2650,- 111,-

2960,- 124,-

2960,- 124,-

2030,- 85,-

2650,- 111,-

2960,- 124,-

2960,- 124,-

620,- 26,-

790,- 33,-

1400,- 59,-

1090,- 46,-

1090,- 46,-

1250,- 53,-

1720,- 72,-

		SNI		Cr		Ms		TiN-K	
		cena pár	EAN	cena pár	EAN	cena pár	EAN	cena pár	EAN
klika / klika	Kč €	2180,- 91,-	86241	2490,- 104,-	86296	2490,- 104,-	054651	3420,- 143,-	86340
klika / klika na rozetách 47x47 mm	Kč €	2790,- 117,-	86258	3110,- 130,-	86302	3110,- 130,-	054668	4050,- 169,-	86357
madlo / klika L na rozetách 47x47 mm	Kč €	3110,- 130,-	86265	3420,- 143,-	86319	3420,- 143,-	054675	4350,- 182,-	86364
madlo / klika R na rozetách 47x47 mm	Kč €	3110,- 130,-	86272	3420,- 143,-	86326	3420,- 143,-	054682	4350,- 182,-	86371
klika / klika	Kč €	2030,- 85,-	86395	2330,- 98,-	86449	2330,- 98,-	054736	3260,- 136,-	86494
klika / klika na rozetách 47x47 mm	Kč €	2650,- 111,-	86401	2960,- 124,-	86456	2960,- 124,-	054743	3890,- 163,-	86500
madlo / klika L na rozetách 47x47 mm	Kč €	2960,- 124,-	86418	3260,- 136,-	86463	3260,- 136,-	054750	4180,- 175,-	86517
madlo / klika R na rozetách 47x47 mm	Kč €	2960,- 124,-	86425	3260,- 136,-	86470	3260,- 136,-	054767	4180,- 175,-	86524
klika / klika	Kč €	2030,- 85,-	86548	2330,- 98,-	86593	2330,- 98,-	054811	3260,- 136,-	86647
klika / klika na rozetách 47x47 mm	Kč €	2650,- 111,-	86555	2960,- 124,-	86609	2960,- 124,-	054828	3890,- 163,-	86654
madlo / klika L na rozetách 47x47 mm	Kč €	2960,- 124,-	86562	3260,- 136,-	86616	3260,- 136,-	054835	4180,- 175,-	86661
madlo / klika R na rozetách 47x47 mm	Kč €	2960,- 124,-	86579	3260,- 136,-	86623	3260,- 136,-	054842	4180,- 175,-	86678
klika / klika	Kč €	2030,- 85,-	86692	2330,- 98,-	86746	2330,- 98,-	054897	3260,- 136,-	86791
klika / klika na rozetách 47x47 mm	Kč €	2650,- 111,-	86708	2960,- 124,-	86753	2960,- 124,-	054903	3890,- 163,-	86807
madlo / klika L na rozetách 47x47 mm	Kč €	2960,- 124,-	86715	3260,- 136,-	86760	3260,- 136,-	054910	4180,- 175,-	86814
madlo / klika R na rozetách 47x47 mm	Kč €	2960,- 124,-	86722	3260,- 136,-	86777	3260,- 136,-	054927	4180,- 175,-	86821
dozické	Kč €	620,- 26,-	86845	790,- 33,-	86869	790,- 33,-	054972	1090,- 46,-	86883
zaslepovací	Kč €	790,- 33,-	021936	930,- 39,-	021943	930,- 39,-	054989	1250,- 53,-	021950
WC	Kč €	1400,- 59,-	86852	1650,- 69,-	86876	1650,- 69,-	054996	2180,- 91,-	86890
dozické	Kč €	1090,- 46,-	86906	1190,- 50,-	86937	1190,- 50,-	055030	1400,- 59,-	86968
cylindrické	Kč €	1090,- 46,-	86913	1190,- 50,-	86944	1190,- 50,-	055047	1400,- 59,-	86975
zaslepovací	Kč €	1250,- 53,-	86920	1340,- 56,-	86951	1340,- 56,-	055054	1550,- 65,-	86982
WC	Kč €	1720,- 72,-	021967	1860,- 78,-	021974	1860,- 78,-	055061	2180,- 91,-	021981

U kombinace madlo / klika dodáváme standardně madlo Minimal pevné - neotočné.

V balení je standardně montážní materiál pro tl. dveří 38 - 45 mm. Pro větší tloušťky dveří je potřeba specifikovat jiný montážní materiál viz. Příslušenství a komponenty str. 376.



reddot design award  
winner 2013

mezinárodní prestižní ocenění za design



Celý projekt - jeden design

Dveřní kliky a kování DESIGN 2013  
řada MINIMAL/MAXIMAL



Kování pro hliníkové a ocelové dveře,  
kování na branky



Kliky a zámky na skleněné dveře



Panty na skleněné dveře



Bezpečnostní rozety



Dveřní zarážky



Okenní kliky  
3 a 4 polohové



Mušle na posuvné  
dveře



Okenní kliky HS Portaly  
na posuvná okna a stěny



Madla dlouhá





## Dveřní kliky DESIGN 2013 řada MINIMAL/MAXIMAL

Materiál: masivní mosaz

Povrchy: SNI, Cr, SNI-broušeno, TiN-C, TiN-B, TiN-K, Ms, Ms-L, Ms-A, TiN-A, Cr-K  
více info na [www.kliky-mt.cz/manufaktura/barvy-povrchy](http://www.kliky-mt.cz/manufaktura/barvy-povrchy)

Kování uvedené na trh v roce 2013 se ihned stalo bestsellerem napříč veškerým kovááním dostupným na středoevropském trhu. Vrcholná nabídka kování Minimal /Maximal, která co do komplexnosti celé řady nemá v klikařském světě obdoby, je jasnou volbou všech, kteří vědí, že na detailu záleží a vyžadují ten největší možný komfort a designovou jednotnost svého projektu. Pro svůj inovativní design a komplexnost výrobní řady s jasným cílem: Celý projekt - jeden design, získalo kování Minimal / Maximal prestižní mezinárodní cenu za design RED DOT Design Award winner 2013. Toto ocenění získala naše společnost jako první v historii ČR a jako jedna z mála v celosvětovém měřítku v segmentu dveřního a okenního kování. Kování řady Maximal je připraveno pro kombinace s vkládanou výplní v nepřeberném množství barevných a materiálových variant.

**MINIMAL TiN-B** titan braun mat

**MAXIMAL Cr** lesklý chrom + výplň sklo - bílá glanz



Klika/klika



Rozety dozické



Rozety WC



Rozety zaslepovací 47x33 mm



Rozety double WC in



Madlo/klika R na rozetách 47x33 mm



Madlo/klika L na rozetách 47x33 mm



Rozety cylindrické čtvercové 47x47 mm



Rozety zaslepovací čtvercové 47x47 mm



dozické



WC in



WC ex



zaslepovací



madlo Minimal

rozety 47x33 mm



cylindrické

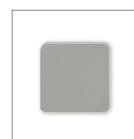

zaslepovací

rozety 47x47 mm

konstrukční varianty, materiálové provedení

- designová sada standardně bez spodních rozet
- spodní rozety se objednávají samostatně
- konstrukční systém 4 tlačných pružin u kliky
- velmi tichý chod celého systému
- montáž sešroubování pouzdry proti sobě
- další pomocná fixace s 8 vruty
- samostatná fixace rozety červíky 2x M4 s možností jemného nastavení polohy rozety/kliky
- rukojeti vyrobeny z masivní mosazi
- rozety vyrobeny z masivní mosazi
- zajišťovací gel proti uvolnění šroubů
- vrtání PROFÍ šablonou M&T vrtákem Ø 6,4 mm
- animace montáže na [www.kliky-mt.cz/montaze-kovani](http://www.kliky-mt.cz/montaze-kovani)
- montáž pro tloušťky dveří 38 – 126 mm
- možnost dodání v protipožárním provedení
- v balení standardně montážní materiál pro tl. dveří 38 - 45 mm
- čtvercové rozety 47x47 mm pro cylindrickou, nebo zaslepovací variantu
- záruka 3 roky, titany 15 let

vrtání PROFÍ šablonou M&T

roky **3 garance**

let **15 garance**



Ochranné známky – registrované značky **MINIMAL®**  
**MAXIMAL®**



Chráněné průmyslové vzory klik

Celou řadu kování **Minimal / Maximal** chrání celkem 26 průmyslových vzorů zaregistrovaných po celém území EU, dokládající jejich původ a originalitu a zabraňující uvádění plagiátů na trh.



Patenty

- konstrukce a systém tlačných pružin u mušle pro posuvné dveře
- WC mechanismus se systémem stabilizace – 4 polohy / 90° s mechanickou dětskou pojistkou
- konstrukce ovládání kliky se systémem tlačných pružin, s velmi tichým chodem a trojitou stabilizací kliky



MINIMAL Cr lesklý chrom

**Dveřní klika Minimal**

3690,- Kč  
154,- EUR

**KČ** materiál: masivní mosaz povrch: SNI matný nikel **EUR**

3690,-		154,-
4320,-		180,-
4320,-		180,-

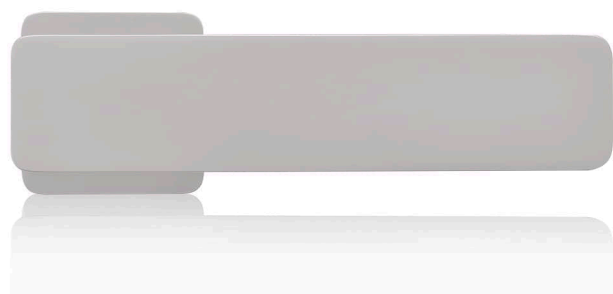

**Klika Minimal**  
na rozetách 47 x 47 mm

3990,- Kč  
167,- EUR

**KČ** materiál: masivní mosaz povrch: SNI matný nikel **EUR**

3990,-		167,-
4620,-		193,-
4620,-		193,-



MINIMAL TiN-C titan chrom mat



MINIMAL TiN-K titan černý mat



MINIMAL SNI matný nikel

**Rozety**

790,- Kč  
33,- EUR

**KČ** materiál: masivní mosaz povrch: SNI matný nikel **EUR**

790,-		33,-
930,-		39,-
1090,-		46,-
1090,-		46,-
1250,-		53,-
1550,-		65,-
1550,-		65,-
1860,-		78,-
1860,-		78,-
1860,-		78,-
1860,-		78,-



Povrchy TiN-A, Ms-L – více na [www.kliky-mt.cz/katalog](http://www.kliky-mt.cz/katalog)  
Protipožární provedení (kovové podrozety + nerezové spojovací prvky, čtyřhran) ... příplatek 490,- Kč ... EAN 082289  
Minimal Objekt (kovové podrozety s mechanikou v 6-ti jstících bodech) ... příplatek 320,- Kč ... EAN 082272  
Panikové provedení = Minimal Objekt + doobjednání správného děleného čtyřhranu na str. 377.



	SNI		SNI - broušeno		Cr		Ms		TiN-C		TiN-B		TiN-K		
	cena	EAN	cena	EAN	cena	EAN	cena	EAN	cena	EAN	cena	EAN	cena	EAN	
	pár		pár		pár		pár		pár		pár		pár		
klika / klika	Kč €	3690,- 154,-	000009	3800,- 159,-	000016	3990,- 167,-	000023	3990,- 167,-	055115	4930,- 206,-	000030	4930,- 206,-	000047	4930,- 206,-	000054
madlo / klika R	Kč €	4320,- 180,-	000078	4400,- 184,-	000085	4620,- 193,-	000092	4620,- 193,-	055122	5710,- 238,-	000108	5710,- 238,-	000115	5710,- 238,-	000122
madlo / klika L	Kč €	4320,- 180,-	000146	4400,- 184,-	000153	4620,- 193,-	000160	4620,- 193,-	055139	5710,- 238,-	000177	5710,- 238,-	000184	5710,- 238,-	000191

U kombinace madlo / klika dodáváme standardně madlo Minimal pevné - neotočné.

V balení je standardně montážní materiál pro tl. dveří 38 - 45 mm. Pro větší tloušťky dveří je potřeba specifikovat jiný montážní materiál viz. Příslušenství a komponenty str. 376.

	SNI		SNI - broušeno		Cr		Ms		TiN-C		TiN-B		TiN-K		
	cena	EAN	cena	EAN	cena	EAN	cena	EAN	cena	EAN	cena	EAN	cena	EAN	
	pár		pár		pár		pár		pár		pár		pár		
klika / klika	Kč €	3990,- 167,-	065138	4100,- 171,-	065169	4320,- 180,-	065190	4320,- 180,-	065343	5250,- 219,-	065220	5250,- 219,-	065251	5250,- 219,-	065282
madlo / klika R	Kč €	4620,- 193,-	065145	4710,- 197,-	065176	4930,- 206,-	065206	4930,- 206,-	065350	6020,- 251,-	065237	6020,- 251,-	065268	6020,- 251,-	065299
madlo / klika L	Kč €	4620,- 193,-	065152	4710,- 197,-	065183	4930,- 206,-	065213	4930,- 206,-	065367	6020,- 251,-	065244	6020,- 251,-	065275	6020,- 251,-	065305



MINIMAL TiN-B titan braun mat



MINIMAL Ms natural mosaz



	SNI		SNI - broušeno		Cr		Ms		TiN-C		TiN-B		TiN-K		
	cena	EAN	cena	EAN	cena	EAN	cena	EAN	cena	EAN	cena	EAN	cena	EAN	
	pár		pár		pár		pár		pár		pár		pár		
dozické	Kč €	790,- 33,-	000467	830,- 35,-	000474	930,- 39,-	000481	930,- 39,-	055177	1090,- 46,-	000498	1090,- 46,-	000504	1090,- 46,-	000511
zaslepovací	Kč €	930,- 39,-	022353	1000,- 42,-	022360	1090,- 46,-	022377	1090,- 46,-	060799	1250,- 53,-	022384	1250,- 53,-	022391	1250,- 53,-	022407
cyldrické 47x47	Kč €	1090,- 46,-	000535	1150,- 48,-	000542	1250,- 53,-	000559	1250,- 53,-	055191	1400,- 59,-	000566	1400,- 59,-	000573	1400,- 59,-	000580
dozické 47x47	Kč €	1090,- 46,-	068429	1150,- 48,-	068436	1250,- 53,-	068443	1250,- 53,-	068450	1400,- 59,-	068467	1400,- 59,-	068474	1400,- 59,-	068481
zaslepovací 47x47	Kč €	1250,- 53,-	022421	1300,- 55,-	022438	1400,- 59,-	022445	1400,- 59,-	055207	1550,- 65,-	022452	1550,- 65,-	022469	1550,- 65,-	022476
WC Minimal	Kč €	1550,- 65,-	000603	1650,- 69,-	000610	1720,- 72,-	000627	1720,- 72,-	055214	2490,- 104,-	000634	2490,- 104,-	000641	2490,- 104,-	000658
WC Maximal	Kč €	1550,- 65,-	000672	1650,- 69,-	000689	1720,- 72,-	000696	1720,- 72,-	055221	2650,- 111,-	000702	2650,- 111,-	000719	2650,- 111,-	000726
WC Minimal double	Kč €	1860,- 78,-	022612	1960,- 82,-	022629	2030,- 85,-	022636	2030,- 85,-	055238	2790,- 117,-	022643	2790,- 117,-	022650	2790,- 117,-	022667
WC Maximal double	Kč €	1860,- 78,-	022681	1960,- 82,-	022698	2030,- 85,-	022704	2030,- 85,-	055245	2960,- 124,-	022711	2960,- 124,-	022728	2960,- 124,-	022735
WC Minimal na rozetách 47x47 *)	Kč €	1860,- 78,-	066685	1960,- 82,-	066692	2030,- 85,-	066708	2030,- 85,-	066715	2790,- 117,-	066722	2790,- 117,-	066739	2790,- 117,-	066746
WC Maximal na rozetách 47x47 *)	Kč €	1860,- 78,-	066753	1960,- 82,-	066760	2030,- 85,-	066777	2030,- 85,-	066784	2960,- 124,-	066791	2960,- 124,-	066807	2960,- 124,-	066814

\*) WC mechanismus nemá systém stabilizace po 90°.



**MAXIMAL SNi - broušeno** matný nikl - broušeno  
výplň dřevo - dýha 3D dub

**Dveřní klika Maximal**

4100,- Kč  
171,- EUR

**KČ** materiál: masivní mosaz  
povrch: SNi matný nikl **EUR**

4100,-		171,-
4710,-		197,-
4710,-		197,-

**Klika Maximal**  
na rozetách 47 x 47 mm

4400,- Kč  
184,- EUR

**KČ** materiál: masivní mosaz  
povrch: SNi matný nikl **EUR**

4400,-		184,-
5020,-		210,-
5020,-		210,-



**MAXIMAL Cr lesklý chrom**  
výplň efekt „sklo“ - bílá glanz

**Výplň kliky Maximal**

200,- Kč  
8,4 EUR



**MAXIMAL WC SNi matný nikl**  
výplň kůže - hnědá čokoládová

**Výplň WC Maximal**

150,- Kč  
6,3 EUR



**SNi matný nikl**

**Madlo Minimal**  
s funkcí kliky

4460,- Kč  
186,- EUR

**KČ** materiál: masivní mosaz  
povrch: SNi matný nikl **EUR**

4460,-		186,-
5080,-		212,-
5080,-		212,-



	Sni		Sni - broušeno		Cr		Ms		TiN-C		TiN-B		TiN-K		
	cena	EAN	cena	EAN	cena	EAN	cena	EAN	cena	EAN	cena	EAN	cena	EAN	
	pár		pár		pár		pár		pár		pár		pár		
klika / klika	Kč €	4100,- 171,-	000214	4180,- 175,-	000221	4400,- 184,-	000238	4400,- 184,-	062632	5320,- 222,-	000245	5320,- 222,-	000252	5320,- 222,-	000269
madlo / klika R	Kč €	4710,- 197,-	000283	4810,- 201,-	000290	5020,- 210,-	000306	5020,- 210,-	062649	5950,- 248,-	000313	5950,- 248,-	000320	5950,- 248,-	000337
madlo / klika L	Kč €	4710,- 197,-	000351	4810,- 201,-	000368	5020,- 210,-	000375	5020,- 210,-	062656	5950,- 248,-	000382	5950,- 248,-	000399	5950,- 248,-	000405

U kombinace madlo / klika dodáváme standardně madlo Minimal pevné - neotočné.

V balení je standardně montážní materiál pro tl. dveří 38 - 45 mm. Pro větší tloušťky dveří je potřeba specifikovat jiný montážní materiál viz. Příslušenství a komponenty str. 376.

	Sni		Sni - broušeno		Cr		Ms		TiN-C		TiN-B		TiN-K		
	cena	EAN	cena	EAN	cena	EAN	cena	EAN	cena	EAN	cena	EAN	cena	EAN	
	pár		pár		pár		pár		pár		pár		pár		
klika / klika	Kč €	4400,- 184,-	065404	4520,- 189,-	065435	4710,- 197,-	065466	4710,- 197,-	065619	5640,- 235,-	065497	5640,- 235,-	065527	5640,- 235,-	065558
madlo / klika R	Kč €	5020,- 210,-	065411	5120,- 214,-	065442	5320,- 222,-	065473	5320,- 222,-	065626	6270,- 262,-	065503	6270,- 262,-	065534	6270,- 262,-	065565
madlo / klika L	Kč €	5020,- 210,-	065428	5120,- 214,-	065459	5320,- 222,-	065480	5320,- 222,-	065633	6270,- 262,-	065510	6270,- 262,-	065541	6270,- 262,-	065572

	cena	EAN	
	ks		
dřevo	Kč €	200,- 8,4	000429
kov	Kč €	200,- 8,4	000436
kůže	Kč €	300,- 13,-	000443
„sklo“	Kč €	300,- 13,-	000450
RAL barvy	Kč €	300,- 13,-	022346

Samostatné komponenty výplně:  
vyměnitelná deska plast ... 79,- Kč / ks EAN 080544  
3M oboustranná nálepka ... 26,- Kč / ks EAN 080551



MAXIMAL Sni matný nikel  
výplň dřevo - dýha wenge

	cena	EAN	
	ks		
dřevo	Kč €	150,- 6,3	000740
kov	Kč €	150,- 6,3	000757
kůže	Kč €	200,- 8,4	000764
„sklo“	Kč €	200,- 8,4	000771
RAL barvy	Kč €	200,- 8,4	022490

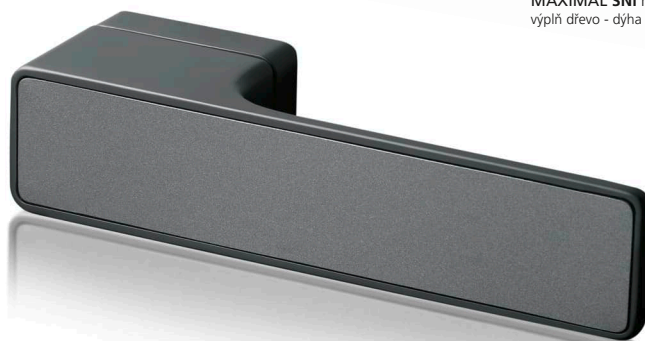

MAXIMAL TiN-K titan černý mat  
výplň kov - šedá perlet



	Sni		Sni - broušeno		Cr		Ms		TiN-C		TiN-B		TiN-K		
	cena	EAN	cena	EAN	cena	EAN	cena	EAN	cena	EAN	cena	EAN	cena	EAN	
	pár		pár		pár		pár		pár		pár		pár		
klika / klika	Kč €	4460,- 186,-	065688	4560,- 190,-	065718	4780,- 200,-	065749	4780,- 200,-	065893	5710,- 238,-	065770	5710,- 238,-	065800	5710,- 238,-	065831
madlo / klika R	Kč €	5080,- 212,-	065695	5180,- 216,-	065725	5390,- 225,-	065756	5390,- 225,-	065909	6480,- 270,-	065787	6480,- 270,-	065817	6480,- 270,-	065848
madlo / klika L	Kč €	5080,- 212,-	065701	5180,- 216,-	065732	5390,- 225,-	065763	5390,- 225,-	065916	6480,- 270,-	065794	6480,- 270,-	065824	6480,- 270,-	065855



MINIMAL SNI  
matný nikl



MAXIMAL SNI matný nikl  
výplň dřevo - dýha teak



MINIMAL II



MAXIMAL II



**Dveřní zarážka**

**Minimal**

**Maximal**

780,- Kč  
33,- EUR



MINIMAL SNI matný nikl



MAXIMAL SNI matný nikl  
výplň dřevo teak

**Výplň zarážky  
Maximal**

89,- Kč  
3,8 EUR

**Mušle Minimal**

5760,- Kč  
240,- EUR

**Mušle Maximal**

5760,- Kč  
240,- EUR

**Výplň mušle  
Maximal**

300,- Kč  
13,- EUR

**Mušle Minimal / Maximal II**

materiál: masivní mosaz  
povrch: SNI matný nikl

**KČ** **EUR**

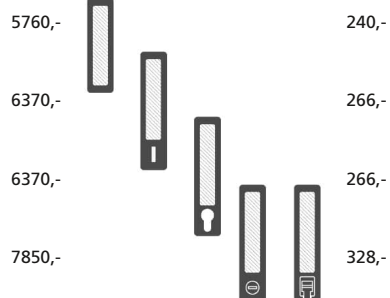
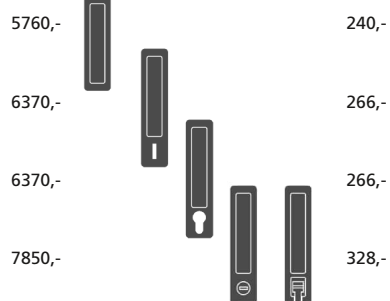

materiál: masivní mosaz  
povrch: SNI matný nikl

**KČ** **EUR**

710,-



30,-

780,-



33,-

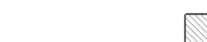



	SNI		SNI - broušeno		Cr		Ms		TiN-C		TiN-B		TiN-K		
	cena	EAN	cena	EAN	cena	EAN	cena	EAN	cena	EAN	cena	EAN	cena	EAN	
standard	Kč €	5760,- 240,-	001211	5950,- 248,-	001228	6050,- 253,-	001235	6050,- 253,-	060836	7390,- 308,-	001242	7390,- 308,-	001259	7390,- 308,-	001266
dozická	Kč €	6370,- 266,-	001280	6560,- 274,-	001297	6660,- 278,-	001303	6660,- 278,-	060843	8040,- 335,-	001310	8040,- 335,-	001327	8040,- 335,-	001334
cylindrická	Kč €	6370,- 266,-	001358	6560,- 274,-	001365	6660,- 278,-	001372	6660,- 278,-	060850	8040,- 335,-	001389	8040,- 335,-	001396	8040,- 335,-	001402
WC / koupelna	Kč €	7850,- 328,-	001426	8070,- 337,-	001433	8250,- 344,-	001440	8250,- 344,-	060867	9670,- 403,-	001457	9670,- 403,-	001464	9670,- 403,-	001471

standard	Kč €	5760,- 240,-	001495	5950,- 248,-	001501	6050,- 253,-	001518	6050,- 253,-	060911	7390,- 308,-	001525	7390,- 308,-	001532	7390,- 308,-	001549
dozická	Kč €	6370,- 266,-	001563	6560,- 274,-	001570	6660,- 278,-	001587	6660,- 278,-	060928	8040,- 335,-	001594	8040,- 335,-	001600	8040,- 335,-	001617
cylindrická	Kč €	6370,- 266,-	001631	6560,- 274,-	001648	6660,- 278,-	001655	6660,- 278,-	060935	8040,- 335,-	001662	8040,- 335,-	001679	8040,- 335,-	001686
WC / koupelna	Kč €	7850,- 328,-	001709	8070,- 337,-	001716	8250,- 344,-	001723	8250,- 344,-	060942	9670,- 403,-	001730	9670,- 403,-	001747	9670,- 403,-	001754

	cena	EAN	
	pár		
dřevo	Kč €	300,- 13,-	001778
kov	Kč €	300,- 13,-	001785
kůže	Kč €	400,- 17,-	001792
„sklo“	Kč €	400,- 17,-	001808
RAL barvy	Kč €	440,- 19,-	022506

více informací na str. 298 - 299 Mušle na posuvné dveře  
Výplně k mušlím Maximal i Maximal II se objednávají pod stejným EAN.

	SNI		Cr		TiN-K		
	cena	EAN	cena	EAN	cena	EAN	
	ks		ks		ks		
Minimal II standard	Kč €	930,- 39,-	101751	1200,- 50,-	101768	1610,- 68,-	101775
Maximal II standard	Kč €	930,- 39,-	101874	1200,- 50,-	101881	1610,- 68,-	101898

Příprava / frézování do dveří je stejné pro všechny mušle  
v provedení standard.

	SNI		SNI - broušeno		Cr		Ms		TiN-C		TiN-B		TiN-K		
	cena	EAN	cena	EAN	cena	EAN	cena	EAN	cena	EAN	cena	EAN	cena	EAN	
	ks		ks		ks		ks		ks		ks		ks		
Minimal	Kč €	710,- 30,-	003277	780,- 33,-	003284	790,- 33,-	003291	790,- 33,-	062588	920,- 39,-	003307	1080,- 45,-	003314	1080,- 45,-	003321
Maximal	Kč €	780,- 33,-	003345	830,- 35,-	003352	860,- 36,-	003369	860,- 36,-	062601	1000,- 42,-	003376	1150,- 48,-	003383	1150,- 48,-	003390

	cena	EAN	
	ks		
dřevo	Kč €	89,- 3,8	003413
kov	Kč €	89,- 3,8	003420
kůže	Kč €	130,- 5,5	003437
„sklo“	Kč €	130,- 5,5	003444
RAL barvy	Kč €	150,- 6,3	022537



více informací na str. 372 - 373 Dveřní zarážky



MINIMAL Cr lesklý chrom

**Zámek na sklo**

**Minimal**

6670,-



278,-

7730,-



323,-

**Maximal**

7150,-



298,-

7150,- Kč

298,- EUR

materiál: masivní mosaz  
povrch: SNI matný nikl

**Kč**

**EUR**



MAXIMAL TIN-B titan braun mat  
výplň dřevo - dýha 3D dub

**Výplň zámku na sklo**

**Maximal**

440,- Kč

19,- EUR



MINIMAL SNI matný nikl



MINIMAL TIN-K titan černý mat



MAXIMAL Cr lesklý chrom  
výplň efekt „sklo“ - bílá glanz

**Protikus na sklo**

6670,- Kč

278,- EUR

6670,-



278,-

7150,-



298,-

**Výplň protikusu na sklo**

**Maximal**

440,- Kč

19,- EUR



**Mušle na sklo**

**Minimal**

4960,-



207,-

**Maximal**

4960,-



207,-

4960,- Kč

207,- EUR

materiál: masivní mosaz  
povrch: SNI matný nikl

**Kč**

**EUR**



MINIMAL Cr lesklý chrom



MINIMAL zapuštěná  
SNI matný nikl



MAXIMAL zapuštěná  
SNI matný nikl + výplň dýha teak

**Okenní klika**

**Minimal**

2570,-



108,-

**Minimal zapuštěná**

2790,-



117,-

**Maximal**

2880,-



120,-

**Maximal zapuštěná**

3110,-



130,-

materiál: masivní mosaz  
povrch: SNI matný nikl

**Kč**

**EUR**





	SNI		SNI - broušeno		Cr		Ms		TiN-C		TiN-B		TiN-K		
	cena	EAN	cena	EAN	cena	EAN	cena	EAN	cena	EAN	cena	EAN	cena	EAN	
	Kč		Kč		Kč		Kč		Kč		Kč		Kč		
Minimal standard	€	6670,- 278,-	000788	6830,- 285,-	000795	7000,- 292,-	000801	7000,- 292,-	061413	7830,- 327,-	000818	7830,- 327,-	000825	7830,- 327,-	000832
Minimal WC	€	7730,- 323,-	080797	7900,- 330,-	080803	8060,- 336,-	080810	8060,- 336,-	080827	8900,- 371,-	080841	8900,- 371,-	080865	8900,- 371,-	080858
Maximal standard	€	7150,- 298,-	000856	7320,- 305,-	000863	7490,- 313,-	000870	7490,- 313,-	061420	8280,- 345,-	000887	8280,- 345,-	000894	8280,- 345,-	000900

	cena	EAN	
	Kč		
dřevo	€	440,- 19,-	000924
kov	€	440,- 19,-	000931

	cena	EAN	
	Kč		
kůže	€	520,- 22,-	000948
efekt „sklo“	€	520,- 22,-	000955
RAL barvy	€	520,- 22,-	080681

více informací na str. 314 - 315 Kování na sklo



	SNI		SNI - broušeno		Cr		Ms		TiN-C		TiN-B		TiN-K		
	cena	EAN	cena	EAN	cena	EAN	cena	EAN	cena	EAN	cena	EAN	cena	EAN	
	Kč		Kč		Kč		Kč		Kč		Kč		Kč		
Minimal	€	6670,- 278,-	000962	6830,- 285,-	000979	7000,- 292,-	000986	7000,- 292,-	061451	7830,- 327,-	000993	7830,- 327,-	001006	7830,- 327,-	001013
Maximal	€	7150,- 298,-	001037	7320,- 305,-	001044	7490,- 313,-	001051	7490,- 313,-	061468	8280,- 345,-	001068	8280,- 345,-	001075	8280,- 345,-	001082

	cena	EAN	
	Kč		
dřevo	€	440,- 19,-	001105
kov	€	440,- 19,-	001112

	cena	EAN	
	Kč		
kůže	€	520,- 22,-	001129
efekt „sklo“	€	520,- 22,-	001136
RAL barvy	€	520,- 22,-	080698



	SNI		SNI - broušeno		Cr		Ms		TiN-C		TiN-B		TiN-K		
	cena	EAN	cena	EAN	cena	EAN	cena	EAN	cena	EAN	cena	EAN	cena	EAN	
	Kč		Kč		Kč		Kč		Kč		Kč		Kč		
Minimal	€	4960,- 207,-	002522	5020,- 210,-	002539	5130,- 214,-	002546	5130,- 214,-	060997	6440,- 269,-	002553	6440,- 269,-	002560	6440,- 269,-	002577
Maximal	€	4960,- 207,-	002591	5020,- 210,-	002607	5130,- 214,-	002614	5130,- 214,-	061000	6440,- 269,-	002621	6440,- 269,-	002638	6440,- 269,-	002645

více informací na str. 304 - 307 Mušle na skleněné posuvné dveře

	SNI		SNI - broušeno		Cr		Ms		TiN-C		TiN-B		TiN-K		
	cena	EAN	cena	EAN	cena	EAN	cena	EAN	cena	EAN	cena	EAN	cena	EAN	
	Kč		Kč		Kč		Kč		Kč		Kč		Kč		
Minimal	€	2570,- 108,-	001815	2640,- 110,-	001822	2740,- 115,-	001839	2740,- 115,-	059694	3200,- 134,-	001846	3200,- 134,-	001853	3200,- 134,-	001860
Minimal zapuštěná	€	2790,- 117,-	071085	2860,- 120,-	071092	2960,- 124,-	071108	2960,- 124,-	071115	3420,- 143,-	071139	3420,- 143,-	071153	3420,- 143,-	071146
Maximal	€	2880,- 120,-	001884	2950,- 123,-	001891	3030,- 127,-	001907	2650,- 111,-	059700	3500,- 146,-	001914	3500,- 146,-	001921	3500,- 146,-	001938
Maximal zapuštěná	€	3110,- 130,-	071177	3190,- 133,-	071184	3260,- 136,-	071191	3260,- 136,-	071207	3720,- 155,-	071221	3720,- 155,-	071245	3720,- 155,-	071238

více informací na str. 258 - 265 Okenní kliky 3 a 4 polohové, u zapuštěné okenní kliky Minimal, Maximal je polohovací mechanismus 3-polohový a je přímo součástí kliky

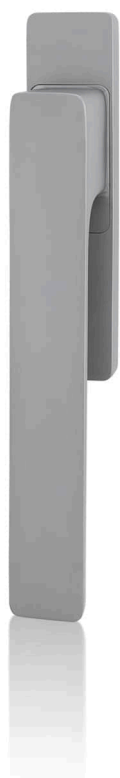

MINIMAL TiN-C titan chrom mat



MINIMAL TiN-K titan černý mat



MAXIMAL SNI matný nikel  
výplň dřevo teak

**Klika 225 mm Minimal**  
k posuvným systémům HS portal

6650,- Kč  
278,- EUR

**Klika 225 mm Maximal**  
k posuvným systémům HS portal

6950,- Kč  
290,- EUR

**Výplň kliky 225 mm**  
Maximal

590,- Kč  
25,- EUR



TiN-C titan chrom mat



TiN-K titan černý mat



SNI matný nikel

**Mušle Minimal venkovní**  
k dveřním systémům HS portal

2800,- Kč  
117,- EUR



MINIMAL Cr lesklý chrom

**Kliky Minimal pro Al profily**

4590,- Kč  
192,- EUR

materiál: masivní mosaz  
povrch: SNI matný nikel

**KČ** **EUR**

6650,- 278,-

13270,- 553,-

13400,- 559,-

2800,- 117,-

2880,- 120,-

6950,- 290,-

13860,- 578,-

13970,- 583,-

materiál: masivní mosaz  
povrch: SNI matný nikel

**KČ** **EUR**

2800,- 117,-

2880,- 120,-

materiál: masivní mosaz  
povrch: SNI matný nikel

**KČ** **EUR**

4590,- 192,-

5210,- 218,-

5210,- 218,-

790,- 33,-



		SNI		SNI - broušeno		Cr		Ms		TiN-C		TiN-B		TiN-K	
		cena	EAN	cena	EAN	cena	EAN	cena	EAN	cena	EAN	cena	EAN	cena	EAN
jednostranná	Kč €	ks 6650,- 278,-	001990	ks 6870,- 287,-	002003	ks 7040,- 294,-	002010	ks 7040,- 294,-	059731	ks 8200,- 342,-	002027	ks 8200,- 342,-	002034	ks 8200,- 342,-	002041
oboustranná	Kč €	pár 13270,- 553,-	002065	pár 13710,- 572,-	002072	pár 14050,- 586,-	002089	pár 14050,- 586,-	059748	pár 16390,- 683,-	002096	pár 16390,- 683,-	002102	pár 16390,- 683,-	002119
oboustranná s cylindr. otvorem	Kč €	pár 13400,- 559,-	002133	pár 13830,- 577,-	002140	pár 14170,- 591,-	002157	pár 14170,- 591,-	059755	pár 16500,- 688,-	002164	pár 16500,- 688,-	002171	pár 16500,- 688,-	002188
mušle venk.	Kč €	ks 2800,- 117,-	002201	ks 2930,- 123,-	002218	ks 3030,- 127,-	002225	ks 3030,- 127,-	059915	ks 3300,- 138,-	002232	ks 3300,- 138,-	002249	ks 3300,- 138,-	002256
mušle venk. s cylindr. otvorem	Kč €	ks 2880,- 120,-	022544	ks 2980,- 125,-	022551	ks 3110,- 130,-	022568	ks 3110,- 130,-	059922	ks 3410,- 143,-	022575	ks 3410,- 143,-	022582	ks 3410,- 143,-	022599

jednostranná	Kč €	ks 6950,- 290,-	002270	ks 7160,- 299,-	002287	ks 7350,- 307,-	002294	ks 7350,- 307,-	059793	ks 8510,- 355,-	002300	ks 8510,- 355,-	002317	ks 8510,- 355,-	002324
oboustranná	Kč €	pár 13860,- 578,-	002348	pár 14280,- 595,-	002355	pár 14630,- 610,-	002362	pár 14630,- 610,-	059809	pár 16970,- 708,-	002379	pár 16970,- 708,-	002386	pár 16970,- 708,-	002393
oboustranná s cylindr. otvorem	Kč €	pár 13970,- 583,-	002416	pár 14410,- 601,-	002423	pár 14740,- 615,-	002430	pár 14740,- 615,-	059816	pár 17070,- 712,-	002447	pár 17070,- 712,-	002454	pár 17070,- 712,-	002461

		cena	EAN
		ks	
dřevo	Kč €	590,- 25,-	002485
kov	Kč €	590,- 25,-	002492
kůže	Kč €	700,- 30,-	002508
efekt „sklo“	Kč €	700,- 30,-	002515
RAL barvy	Kč €	730,- 31,-	022513

více informací na str. 266 - 269 HS portaly



		SNI		SNI - broušeno		Cr		Ms		TiN-C		TiN-B		TiN-K	
		cena	EAN	cena	EAN	cena	EAN	cena	EAN	cena	EAN	cena	EAN	cena	EAN
mušle venkovní	Kč €	ks 2800,- 117,-	002201	ks 2930,- 123,-	002218	ks 3030,- 127,-	002225	ks 3030,- 127,-	059915	ks 3300,- 138,-	002232	ks 3300,- 138,-	002249	ks 3300,- 138,-	002256
mušle venk. s cylindr. otvorem	Kč €	ks 2880,- 120,-	022544	ks 2980,- 125,-	022551	ks 3110,- 130,-	022568	ks 3110,- 130,-	059922	ks 3410,- 143,-	022575	ks 3410,- 143,-	022582	ks 3410,- 143,-	022599

		SNI		SNI - broušeno		Cr		Ms		TiN-C		TiN-B		TiN-K	
		cena	EAN	cena	EAN	cena	EAN	cena	EAN	cena	EAN	cena	EAN	cena	EAN
klíka / klíka	Kč €	pár 4590,- 192,-	003062	pár 4660,- 195,-	003079	pár 4870,- 203,-	003086	pár 4870,- 203,-	060256	pár 5990,- 250,-	003093	pár 5990,- 250,-	003109	pár 5990,- 250,-	003116
madlo / klíka R	Kč €	pár 5210,- 218,-	003130	pár 5290,- 221,-	003147	pár 5490,- 229,-	003154	pár 5490,- 229,-	060263	pár 6610,- 276,-	003161	pár 6610,- 276,-	003178	pár 6610,- 276,-	003185
madlo / klíka L	Kč €	pár 5210,- 218,-	003208	pár 5290,- 221,-	003215	pár 5490,- 229,-	003222	pár 5490,- 229,-	060270	pár 6610,- 276,-	003239	pár 6610,- 276,-	003246	pár 6610,- 276,-	003253
rozeta cylindrická 33x47 mm	Kč €	pár 790,- 33,-	001952	pár 830,- 35,-	001969	pár 870,- 37,-	001976	pár 870,- 37,-	060775	pár 1250,- 53,-	001983	pár 1250,- 53,-	002669	pár 1250,- 53,-	002676

více informací na str. 274 - 277 Kování pro hliníkové a ocelové dveře



MINIMAL TiN-K titan černý mat



MINIMAL TiN-B titan braun mat



MAXIMAL SNI matný nikl  
výplň dřevo teak

**Madlo dlouhé Minimal**  
rozteč 250 / délka 297 mm

11560,- Kč  
482,- EUR

**Madlo dlouhé Maximal**  
rozteč 250 / délka 297 mm

11960,- Kč  
499,- EUR

**Výplň madla Maximal**

590,- Kč  
25,- EUR

**KČ** materiál: masivní mosaz povrch: SNI matný nikl **EUR**

11560,-		482,-
5800,-		242,-

11960,-		499,-
6000,-		250,-



SNI matný nikl



TiN-K titan černý mat



TiN-B titan braun mat

**Bezpečnostní rozeta Minimal**

4380,- Kč  
183,- EUR

**KČ** materiál: zušlechťená ocel povrch: SNI matný nikl **EUR**

pro tl. dveří		
4380,-	38 - 45 mm	183,-
4540,-	46 - 52 mm	190,-
4690,-	53 - 60 mm	196,-
4980,-	61 - 68 mm	208,-
5120,-	69 - 76 mm	214,-
5270,-	77 - 83 mm	220,-
5570,-	84 - 90 mm	233,-
5850,-	91 - 97 mm	244,-
6140,-	98 - 104 mm	256,-
6430,-	105 - 112 mm	268,-
6740,-	113 - 118 mm	281,-
7030,-	119 - 126 mm	293,-



	SNi		SNi - broušeno		Cr		Ms		TiN-C		TiN-B		TiN-K		
	cena	EAN	cena	EAN	cena	EAN	cena	EAN	cena	EAN	cena	EAN	cena	EAN	
oboustranné	Kč €	pár 11560,- 482,-	002706	pár 11890,- 496,-	002713	pár 12260,- 511,-	002720	pár 12260,- 511,-	058819	pár 14480,- 604,-	002737	pár 14480,- 604,-	002744	pár 14480,- 604,-	002751
jednostranné	Kč €	ks 5800,- 242,-	002775	ks 5950,- 248,-	002782	ks 6140,- 256,-	002799	ks 6140,- 256,-	058826	ks 7250,- 303,-	002805	ks 7250,- 303,-	002812	ks 7250,- 303,-	002829
oboustranné	Kč €	pár 11960,- 499,-	002843	pár 12300,- 513,-	002850	pár 12630,- 527,-	002867	pár 12630,- 527,-	058857	pár 14930,- 623,-	002874	pár 14930,- 623,-	002881	pár 14930,- 623,-	002898
jednostranné	Kč €	ks 6000,- 250,-	002911	ks 6160,- 257,-	002928	ks 6330,- 264,-	002935	ks 6330,- 264,-	058864	ks 7480,- 312,-	002942	ks 7480,- 312,-	002959	ks 7480,- 312,-	002966

	cena	EAN	
	ks		
dřevo	Kč €	590,- 25,-	002980
kov	Kč €	590,- 25,-	002997
kůže	Kč €	700,- 30,-	003000
efekt „sklo“	Kč €	700,- 30,-	003017
RAL barvy	Kč €	730,- 31,-	022520

více informací na str. 214 - 217 Dlouhá madla

Montážní materiál pro madla	cena	EAN	
	sada		
jednostranné do slepé díry - plast	Kč €	390,- 17,-	030204
jednostranné do slepé díry - hliník	Kč €	390,- 17,-	030211
jednostranné do slepé díry - dřevo	Kč €	390,- 17,-	030228

Montážní materiál pro madla	cena	EAN	
	sada		
jednostranné s prošroubováním a záslepkou	Kč €	390,- 17,-	003024
jednostranné na sklo s prošroubováním a záslepkou	Kč €	510,- 22,-	003031
oboustranné	Kč €	390,- 17,-	003048
oboustranné na sklo	Kč €	510,- 22,-	003055

	SNi		SNi - broušeno		Cr		TiN-C		TiN-B		TiN-K		K-industrial		
	cena	EAN	cena	EAN	cena	EAN	cena	EAN	cena	EAN	cena	EAN	cena	EAN	
	ks		ks		ks		ks		ks		ks		ks		
pro tl. dveří															
38 - 45 mm	Kč €	4380,- 183,-	020977	4380,- 183,-	021097	4540,- 190,-	021219	5120,- 214,-	021332	5120,- 214,-	021455	5120,- 214,-	021578	5120,- 214,-	142655
46 - 52 mm	Kč €	4540,- 190,-	020984	4540,- 190,-	021103	4690,- 196,-	021226	5270,- 220,-	021349	5270,- 220,-	021462	5270,- 220,-	021585	5270,- 220,-	142662
53 - 60 mm	Kč €	4690,- 196,-	020991	4690,- 196,-	021110	4830,- 202,-	021233	5410,- 226,-	021356	5410,- 226,-	021479	5410,- 226,-	021592	5410,- 226,-	142679
61 - 68 mm	Kč €	4980,- 208,-	021004	4980,- 208,-	021127	5120,- 214,-	021240	5710,- 238,-	021363	5710,- 238,-	021486	5710,- 238,-	021608	5710,- 238,-	142686
69 - 76 mm	Kč €	5120,- 214,-	021011	5120,- 214,-	021134	5270,- 220,-	021257	5850,- 244,-	021370	5850,- 244,-	021493	5850,- 244,-	021615	5850,- 244,-	142693
77 - 83 mm	Kč €	5270,- 220,-	021028	5270,- 220,-	021141	5410,- 226,-	021264	6000,- 250,-	021387	6000,- 250,-	021509	6000,- 250,-	021622	6000,- 250,-	142709
84 - 90 mm	Kč €	5570,- 233,-	021035	5570,- 233,-	021158	5710,- 238,-	021271	6300,- 263,-	021394	6300,- 263,-	021516	6300,- 263,-	021639	6300,- 263,-	142716
91 - 97 mm	Kč €	5850,- 244,-	021042	5850,- 244,-	021165	6000,- 250,-	021288	6580,- 275,-	021400	6580,- 275,-	021523	6580,- 275,-	021646	6580,- 275,-	142723
98 - 104 mm	Kč €	6140,- 256,-	021059	6140,- 256,-	021172	6300,- 263,-	021295	6870,- 287,-	021417	6870,- 287,-	021530	6870,- 287,-	021653	6870,- 287,-	142730
105 - 112 mm	Kč €	6430,- 268,-	021066	6430,- 268,-	021189	6580,- 275,-	021301	7170,- 299,-	021424	7170,- 299,-	021547	7170,- 299,-	021660	7170,- 299,-	142747
113 - 118 mm	Kč €	6740,- 281,-	021073	6740,- 281,-	021196	6870,- 287,-	021318	7460,- 311,-	021431	7460,- 311,-	021554	7460,- 311,-	021677	7460,- 311,-	142754
119 - 126 mm	Kč €	7030,- 293,-	021080	7030,- 293,-	021202	7170,- 299,-	021325	7760,- 324,-	021448	7760,- 324,-	021561	7760,- 324,-	021684	7760,- 324,-	142761

více informací na str. 206 - 213 Bezpečnostní rozety



## **Minimal 2.0 WC integrated**

minimalistické maximum

v působivém celku je hodinářským způsobem integrován systém komfortního zamykání a zároveň skrytého nouzového otevření

design: Roman Ulich

## Dveřní kliky DESIGN 2021 Minimal 2.0

Design: Roman Ulich

Materiál: masivní mosaz

Povrchy: SNi, SNi-broušeno, Cr, TiN-A, TiN-C, TiN-B, TiN-K, Ms, Ms-L, Ms-A, Cr-K  
více info na [www.kliky-mt.cz/manufaktura/barvy-povrchy](http://www.kliky-mt.cz/manufaktura/barvy-povrchy)

Konstrukce, mechanika: mosazné rozety 53x33 mm, mechanika M2011 Minimal

### MINIMAL 2.0

**Cr-K** černý chrom broušený



Klika/klika



Madlo/klika R



Madlo/klika L

### MINIMAL 2.0 WC integrated

**TiN-A** titan mosaz mat

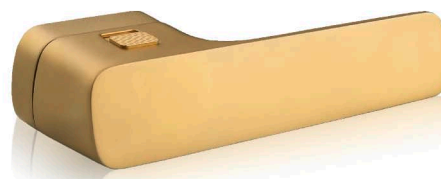

Klika/klika R WC integrated



Klika/klika L WC integrated



Rozety dozické



Rozety WC



Rozety zaslepovací 53x33 mm



Rozety cylindrické 47x47 mm



Rozety zaslepovací 47x47 mm



dozické



WC in



WC ex



zaslepovací



madlo Minimal 2.0



cylindrické



zaslepovací

rozety 53x33 mm

rozety 47x47 mm

konstrukční varianty, materiálové provedení

- designová sada standardně bez spodních rozet
- spodní rozety se objednávají samostatně
- konstrukční systém 4 tlačných pružin u kliky
- velmi tichý chod celého systému
- montáž sešroubování pouzdry proti sobě
- další pomocná fixace s 8 vruty
- samostatná fixace rozety červíky 2x M4
- rukojeti vyrobeny z masivní mosazi
- rozety vyrobeny z masivní mosazi
- zajišťovací gel proti uvolnění šroubů
- vrtání PROFÍ šablonou M&T vrtákem Ø 6,4 mm
- animace montáže na [www.kliky-mt.cz/montaze-kovani](http://www.kliky-mt.cz/montaze-kovani)
- montáž pro tloušťky dveří 38,5 – 124 mm
- možnost dodání v protipožárním provedení
- v balení standardně montážní materiál pro tl. dveří 38,5 – 44 mm
- čtvercové rozety 47x47 mm pro cylindrickou, nebo zaslepovací variantu
- čtyřhrany pro WC integrated jsou odstupňovány v délkách po 5 mm, nutno do objednávky uvádět přesnou tloušťku dveří od dveří tloušťky 44 mm
- záruka 3 roky, titany 15 let

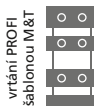

Ochranné známky – registrované značky **MINIMAL®**



Chráněné průmyslové vzory klik

**MINIMAL 2.0**  
**MINIMAL 2.0 WC**  
**INTEGRATED**



Patenty

- konstrukce blokování + nouzového otevření kliky Minimal 2.0 WC integrated

roky **3** garance

let **15** garance



MINIMAL 2.0 **TiN-K** titan černý mat

**Minimal 2.0**

4140,- Kč  
173,- EUR

KČ	materiál: masivní mosaz povrch: SNi matný nikel	EUR
4140,-		173,-
4800,-		200,-
4800,-		200,-



MINIMAL 2.0 **SNi-broušeno** matný nikel-broušený

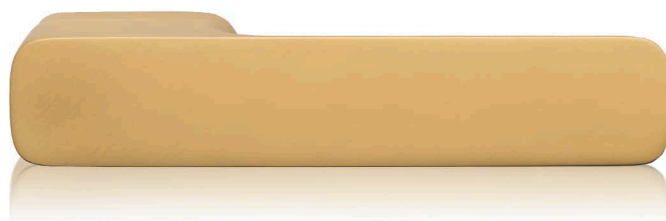

MINIMAL 2.0 **TiN-A** titan mosaz mat



Madlo MINIMAL 2.0 **TiN-A** titan mosaz mat

**Spodní rozety**

900,- Kč  
38,- EUR

KČ	materiál: masivní mosaz povrch: SNi matný nikel	EUR
900,-		38,-
1050,-		44,-
1640,-		69,-
1980,-		83,-





		SNI		SNI - broušeno		Cr		Ms		Ms-L		Ms-A	
		cena pár	EAN	cena pár	EAN	cena pár	EAN	cena pár	EAN	cena pár	EAN	cena pár	EAN
klika / klika	Kč €	4140,- 173,-	147438	4240,- 177,-	147483	4460,- 186,-	147537	4460,- 186,-	147582	4460,- 186,-	147636	4460,- 186,-	147681
madlo / klika R	Kč €	4800,- 200,-	147469	4920,- 205,-	147513	5110,- 213,-	147568	5110,- 213,-	147612	5110,- 213,-	147667	5110,- 213,-	147711
madlo / klika L	Kč €	4800,- 200,-	147476	4920,- 205,-	147520	5110,- 213,-	147575	5110,- 213,-	147629	5110,- 213,-	147674	5110,- 213,-	147728

		TiN-C		TiN-K		TiN-B		TiN-A		Cr-K	
		cena pár	EAN	cena pár	EAN	cena pár	EAN	cena pár	EAN	cena pár	EAN
klika / klika	Kč €	5400,- 225,-	147735	5400,- 225,-	147780	5400,- 225,-	147834	5400,- 225,-	147889	6110,- 255,-	147933
madlo / klika R	Kč €	6210,- 259,-	147766	6210,- 259,-	147810	6210,- 259,-	147865	6210,- 259,-	147919	6860,- 286,-	147964
madlo / klika L	Kč €	6210,- 259,-	147773	6210,- 259,-	147827	6210,- 259,-	147872	6210,- 259,-	147926	6860,- 286,-	147971



MINIMAL 2.0 Cr-K černý chrom broušený 3D



MINIMAL 2.0 SNI matný nikel

		SNI		SNI - broušeno		Cr		Ms		Ms-L		Ms-A	
		cena pár	EAN	cena pár	EAN	cena pár	EAN	cena pár	EAN	cena pár	EAN	cena pár	EAN
dozické	Kč €	900,- 38,-	147988	950,- 40,-	148039	1050,- 44,-	148084	1050,- 44,-	148138	1050,- 44,-	148183	1050,- 44,-	148237
zaslepovací	Kč €	1050,- 44,-	147995	1110,- 47,-	148046	1200,- 50,-	148091	1200,- 50,-	148145	1200,- 50,-	148190	1200,- 50,-	148244
WC	Kč €	1640,- 69,-	148015	1730,- 73,-	148060	1820,- 76,-	148114	1820,- 76,-	148169	1820,- 76,-	148213	1820,- 76,-	148268
WC double	Kč €	1980,- 83,-	147025	2070,- 87,-	148077	2160,- 90,-	148121	2160,- 90,-	148176	2160,- 90,-	148220	2160,- 90,-	148275

		TiN-C		TiN-K		TiN-B		TiN-A		Cr-K	
		cena pár	EAN	cena pár	EAN	cena pár	EAN	cena pár	EAN	cena pár	EAN
dozické	Kč €	1200,- 50,-	148282	1200,- 50,-	148336	1200,- 50,-	148381	1200,- 50,-	148435	1430,- 60,-	148480
zaslepovací	Kč €	1360,- 57,-	148299	1360,- 57,-	148343	1360,- 57,-	148398	1360,- 57,-	148442	1360,- 57,-	148497
WC	Kč €	2630,- 110,-	148312	2630,- 110,-	148367	2630,- 110,-	148411	2630,- 110,-	148466	3010,- 126,-	148510
WC double	Kč €	2960,- 124,-	148329	2960,- 124,-	148374	2960,- 124,-	148428	2960,- 124,-	148473	3340,- 140,-	148527



MINIMAL 2.0 WC integrated **SNi** matný nikel

**Minimal 2.0  
WC integrated**

6440,- Kč  
269,- EUR

**Kč** materiál: masivní mosaz povrch: **SNi matný nikel** **EUR**

6440,-  269,-

6440,-  269,-



MINIMAL 2.0 WC integrated **Cr-K** černý chrom broušený 3D



MINIMAL 2.0 WC integrated **TiN-A** titan mosaz mat

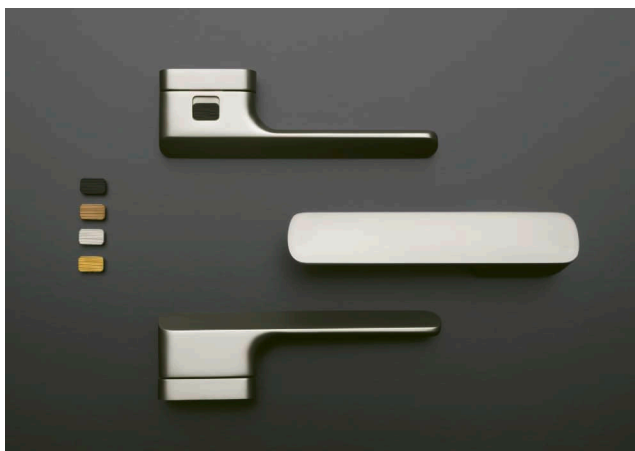

Automaticky dodáváme celé kování včetně ovládacího / blokovacího segmentu vždy v jednotném povrchu. Zakázkově lze u WC integrated zvolit odlišnou povrchovou úpravu ovládacího / blokovacího segmentu, tzn. odlišit dotykovou / ovládací plochu oproti povrchu celé kliky.

**Spodní rozety**

1090,- Kč  
46,- EUR

**Kč** materiál: masivní mosaz povrch: **SNi matný nikel** **EUR**

1090,-  46,-

1250,-  53,-



MINIMAL 2.0 WC integrated **TiN-K** titan černý mat



		SNI		SNI - broušeno		Cr		Ms		Ms-L		Ms-A	
		cena pár	EAN	cena pár	EAN	cena pár	EAN	cena pár	EAN	cena pár	EAN	cena pár	EAN
klika / klika R WC integrated	Kč €	6440,- 269,-	147445	6680,- 279,-	147490	7150,- 298,-	147544			7150,- 298,-	147643	7150,- 298,-	147698
klika / klika L WC integrated	Kč €	6440,- 269,-	147452	6680,- 279,-	147506	7150,- 298,-	147551			7150,- 298,-	147650	7150,- 298,-	147704

		TiN-C		TiN-K		TiN-B		TiN-A		Cr-K	
		cena pár	EAN	cena pár	EAN	cena pár	EAN	cena pár	EAN	cena pár	EAN
klika / klika R WC integrated	Kč €	8250,- 344,-	147742	8250,- 344,-	147797	8250,- 344,-	147841	8250,- 344,-	147896	9230,- 385,-	147940
klika / klika L WC integrated	Kč €	8250,- 344,-	147759	8250,- 344,-	147803	8250,- 344,-	147858	8250,- 344,-	147902	9230,- 385,-	147957

Konstrukce klik se systémem WC integrated vyžaduje dodání vždy přesné délky ovládacího čtyřhranu a dalších komponentů pro konkrétní tloušťku dveří viz. tabulka montážního materiálu pro tloušťky dveří po 5 mm. Montážní materiál pro standardní tloušťku dveří 38,5 - 44 mm je součástí dodávky a je v ceně dodávky.



MINIMAL 2.0 WC integrated TiN-B titan braun mat

Rozměrové varianty							
tloušťka dveří		cena sada	EAN	tloušťka dveří	cena sada	EAN	
44,1 - 49 mm	Kč €	130,- 5,5	145014	64,1 - 69 mm	Kč €	250,- 11,-	145052
49,1 - 54 mm	Kč €	160,- 6,7	145021	69,1 - 74 mm	Kč €	280,- 12,-	145069
54,1 - 59 mm	Kč €	180,- 7,5	145038	74,1 - 79 mm	Kč €	310,- 13,-	145076
59,1 - 64 mm	Kč €	210,- 8,8	145045	79,1 mm a více*	Kč €	360,- 15,-	145083

\* nutno určit přesnou tloušťku dveří

		SNI		SNI - broušeno		Cr		Ms		Ms-L		Ms-A	
		cena pár	EAN	cena pár	EAN	cena pár	EAN	cena pár	EAN	cena pár	EAN	cena pár	EAN
cylindrické 47x47 mm	Kč €	1090,- 46,-	000535	1150,- 48,-	000542	1250,- 53,-	000559	1250,- 53,-	055191	1250,- 53,-	055276	1250,- 53,-	148503
zaslepovací 47x47 mm	Kč €	1250,- 53,-	022421	1300,- 55,-	022438	1400,- 59,-	022445	1400,- 59,-	055207	1400,- 59,-	055283	1550,- 65,-	152623

		TiN-C		TiN-K		TiN-B		TiN-A		Cr-K	
		cena pár	EAN	cena pár	EAN	cena pár	EAN	cena pár	EAN	cena pár	EAN
cylindrické 47x47 mm	Kč €	1400,- 59,-	000566	1400,- 59,-	000580	1400,- 59,-	000573	1400,- 59,-	000597	1710,- 72,-	087703
zaslepovací 47x47 mm	Kč €	1550,- 65,-	022452	1550,- 65,-	022476	1550,- 65,-	022469	1550,- 65,-	022483		

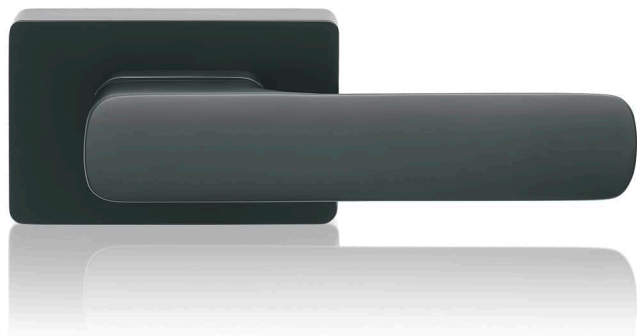

**Zámek na sklo**

**Kč** materiál: masivní mosaz povrch: SNI matný nikel **EUR**

**Minimal**

6670,-



278,-

6670,- Kč

278,- EUR

Kompletní sada na sklo se skládá ze zámku na sklo Minimal a klik s rozetou (tj. klika stejná jako u dřevěných dveří, která se i s rozetou montuje na zámek na sklo).

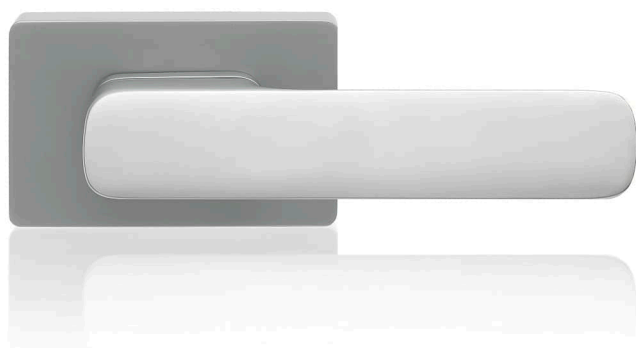

**Kliky-rukojeti k zámkům na sklo**

**Kč** materiál: masivní mosaz povrch: SNI matný nikel **EUR**

4140,-



173,-

6440,-



269,-

6440,-



269,-

zámek na sklo



klika-rukojet



levá



pravá

**Okenní klika**

**Kč** materiál: masivní mosaz povrch: SNI matný nikel **EUR**

**Minimal 2.0**

2770,-



116,-

2770,- Kč

116,- EUR

		SNI		SNI - broušeno		Cr		Ms		Ms-L		Ms-A	
		cena	EAN	cena	EAN	cena	EAN	cena	EAN	cena	EAN	cena	EAN
		pár		pár		pár		pár		pár		pár	
Minimal standard	Kč €	6670,- 278,-	000788	6830,- 285,-	000795	7000,- 292,-	000801	7000,- 292,-	061413	7000,- 292,-	061437	7710,- 322,-	155990

		TiN-C		TiN-K		TiN-B		TiN-A		Cr-K	
		cena	EAN	cena	EAN	cena	EAN	cena	EAN	cena	EAN
		pár		pár		pár		pár		pár	
Minimal standard	Kč €	7830,- 327,-	000818	7830,- 327,-	000832	7830,- 327,-	000825	7830,- 327,-	000849	7830,- 327,-	156003

Pro tl. dveří 10 mm jsou v případě potřeby připraveny zámkové se sníženou/užší střílkou o 2 mm... EAN 068498 příplatek ke katalogové ceně zámku + 680 Kč bez další slevy.

		SNI		SNI - broušeno		Cr		Ms		Ms-L		Ms-A	
		cena	EAN	cena	EAN	cena	EAN	cena	EAN	cena	EAN	cena	EAN
		pár		pár		pár		pár		pár		pár	
Minimal 2.0 klika / klika	Kč €	4140,- 173,-	147438	4240,- 177,-	147483	4460,- 186,-	147537	4460,- 186,-	147582	4460,- 186,-	147636	4460,- 186,-	147681
Minimal 2.0 WC integrated klika / klika R	Kč €	6440,- 269,-	147445	6680,- 279,-	147490	7150,- 298,-	147544			7150,- 298,-	147643	7150,- 298,-	147698
Minimal 2.0 WC integrated klika / klika L	Kč €	6440,- 269,-	147452	6680,- 279,-	147506	7150,- 298,-	147551			7150,- 298,-	147650	7150,- 298,-	147704

		TiN-C		TiN-K		TiN-B		TiN-A		Cr-K	
		cena	EAN	cena	EAN	cena	EAN	cena	EAN	cena	EAN
		pár		pár		pár		pár		pár	
Minimal 2.0 klika / klika	Kč €	5400,- 225,-	147735	5400,- 225,-	147780	5400,- 225,-	147834	5400,- 225,-	147889	6110,- 255,-	147933
Minimal 2.0 WC integrated klika / klika R	Kč €	8250,- 344,-	147742	8250,- 344,-	147797	8250,- 344,-	147841	8250,- 344,-	147896	9230,- 385,-	147940
Minimal 2.0 WC integrated klika / klika L	Kč €	8250,- 344,-	147759	8250,- 344,-	147803	8250,- 344,-	147858	8250,- 344,-	147902	9230,- 385,-	147957

		SNI		SNI - broušeno		Cr		Ms		Ms-L		Ms-A	
		cena	EAN	cena	EAN	cena	EAN	cena	EAN	cena	EAN	cena	EAN
		pár		pár		pár		pár		pár		pár	
pravá	Kč €	2770,- 116,-	155778	2840,- 119,-	155792	2940,- 123,-	155815	2940,- 123,-	155839	2940,- 123,-	155853	3240,- 135,-	155877
levá	Kč €	2770,- 116,-	155785	2840,- 119,-	155808	2940,- 123,-	155822	2940,- 123,-	155846	2940,- 123,-	155860	3240,- 135,-	155884

		TiN-C		TiN-K		TiN-B		TiN-A		Cr-K	
		cena	EAN	cena	EAN	cena	EAN	cena	EAN	cena	EAN
		pár		pár		pár		pár		pár	
pravá	Kč €	3400,- 142,-	155891	3400,- 142,-	155914	3400,- 142,-	155938	3400,- 142,-	155952	3750,- 157,-	155976
levá	Kč €	3400,- 142,-	155907	3400,- 142,-	155921	3400,- 142,-	155945	3400,- 142,-	155969	3750,- 157,-	155983

## Minimal 2.0

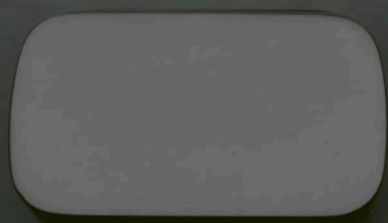
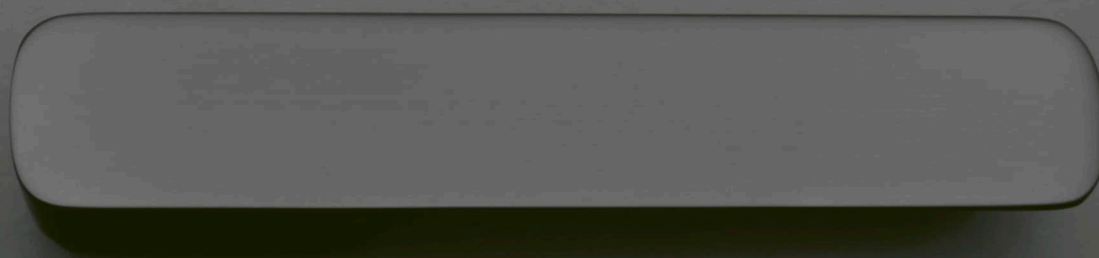

Nezaměnitelný organický tvar

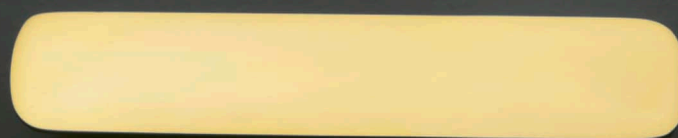
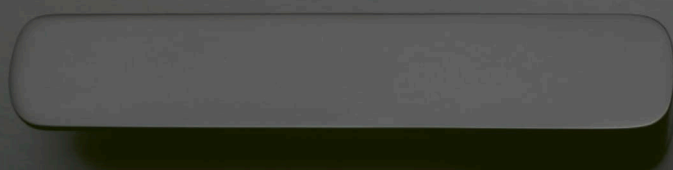
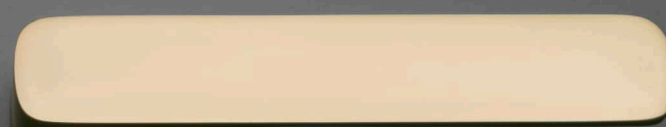
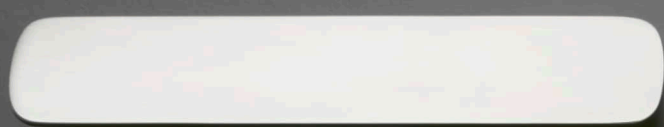

Dokonalá ergonomie

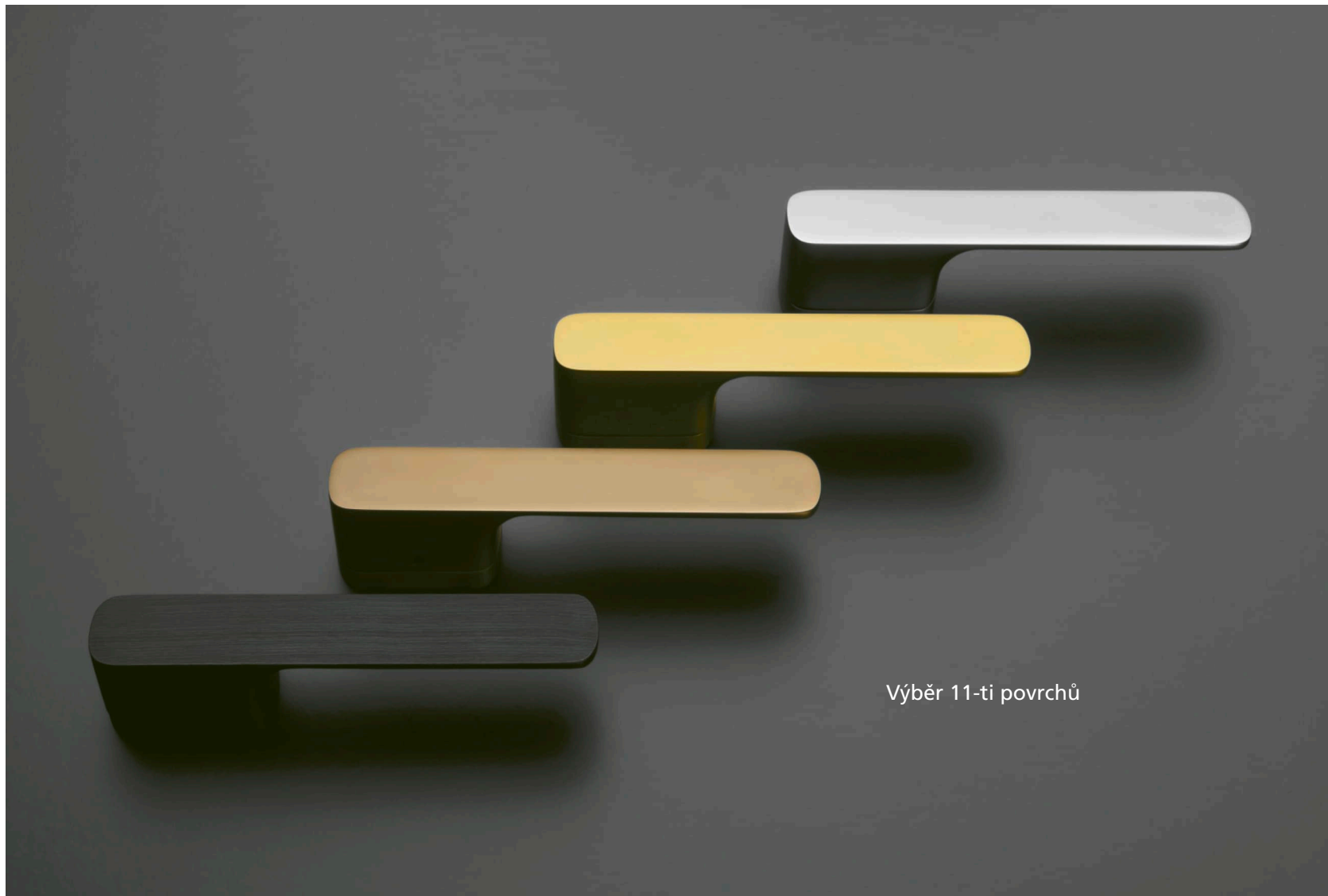

Výběr 11-ti povrchů

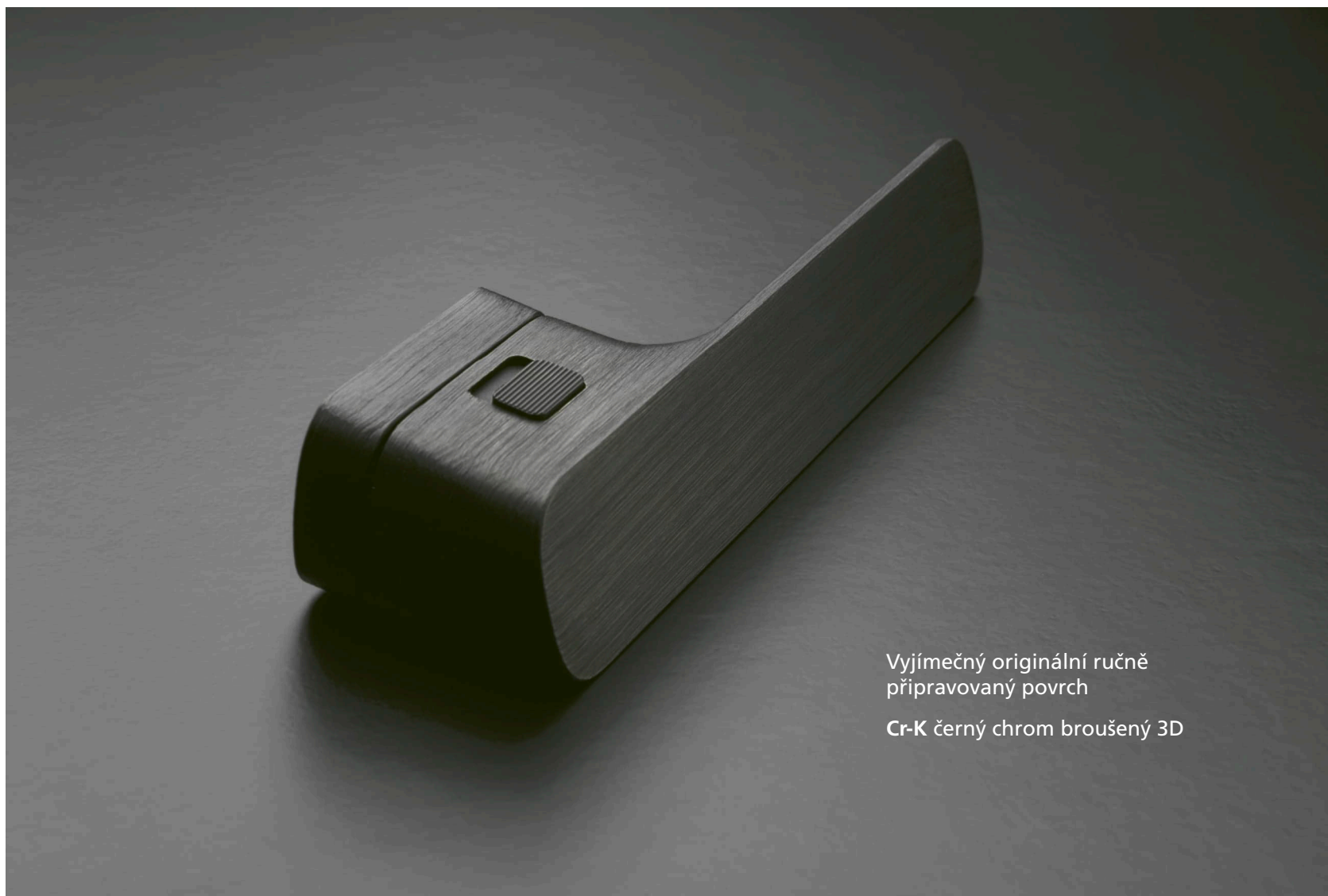

Vyjímečný originální ručně  
připravovaný povrch

Cr-K černý chrom broušený 3D

## Minimal 2.0 WC integrated



### Integrované WC zamykání

(blokuje se klika ne zámek .... systém funguje na všech dveřích s jakýmkoliv běžným zámekem, tj. se zámekem dozickým, WC, cylindrickým)

### Neviditelné nouzové S.O.S. otevření

(umístěné na vnější klice ze spodu .... stačí vsunout jakýkoliv předmět do úzké drážky a posunout blokovací mechanismus .... klika se na druhé straně dveří odjistí/odblokuje)







Možnost volby barevného povrchu  
uzamykacího segmentu

(standardně se dodává v jednotném povrchu s klikou)

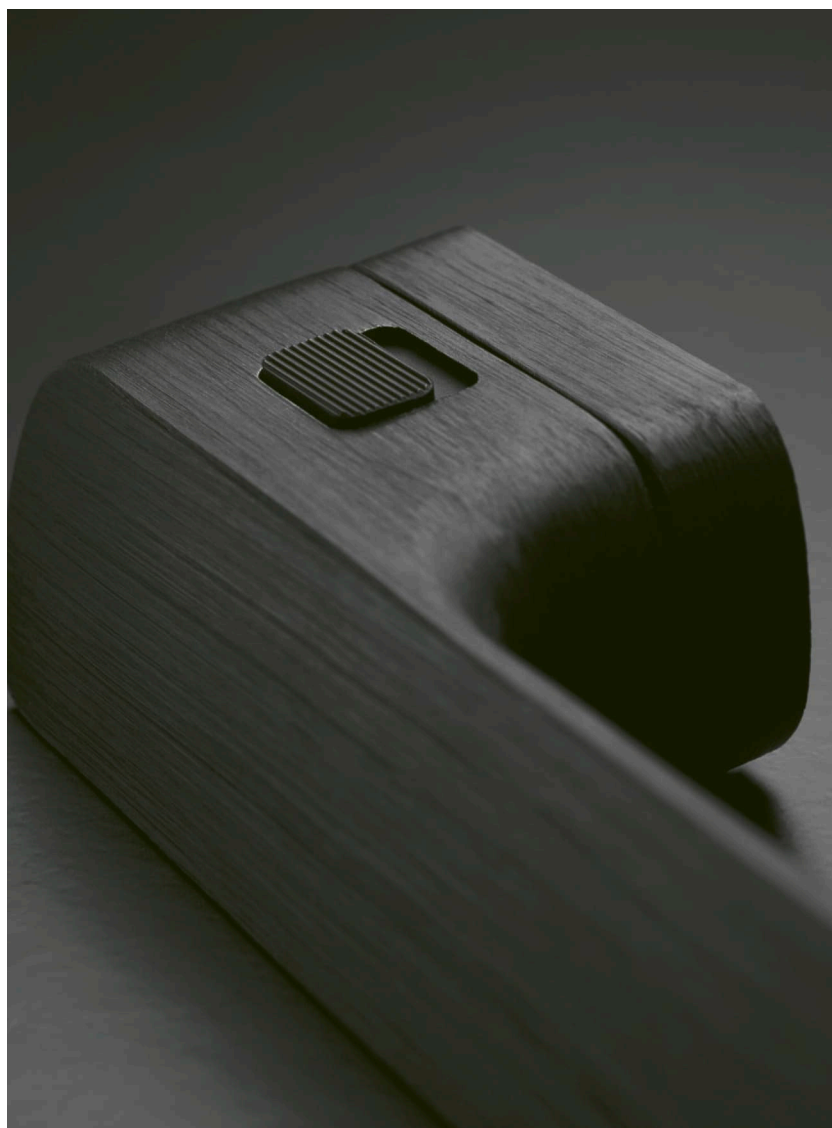

# MAG

## SYSTÉM NEODYM ULTRA MAGNET KONCEPT

rychle, pevně, pouhým nacvaknutím dlouhodobě fixuje krycí  
pohledové rozety k základně/vnitřní rozetě



ČTVERCOVÁ 54×54 mm

KULATÁ Ø 54 mm



## SYSTÉM FIX M6

fixace klik k ovládacímu čtyřhranu pomocí speciálně  
tvarovanému červíku M6, kdy se celá došedací plocha  
zatlačí do připravené drážky čtyřhranu a tím znemožní  
jakémukoliv pozdějšímu nechtěnému uvolnění kliky.

S červíkem dodáván zajišťovací gel zabráňující  
samovolnému uvolnění

# NETICKÉ ROZETY

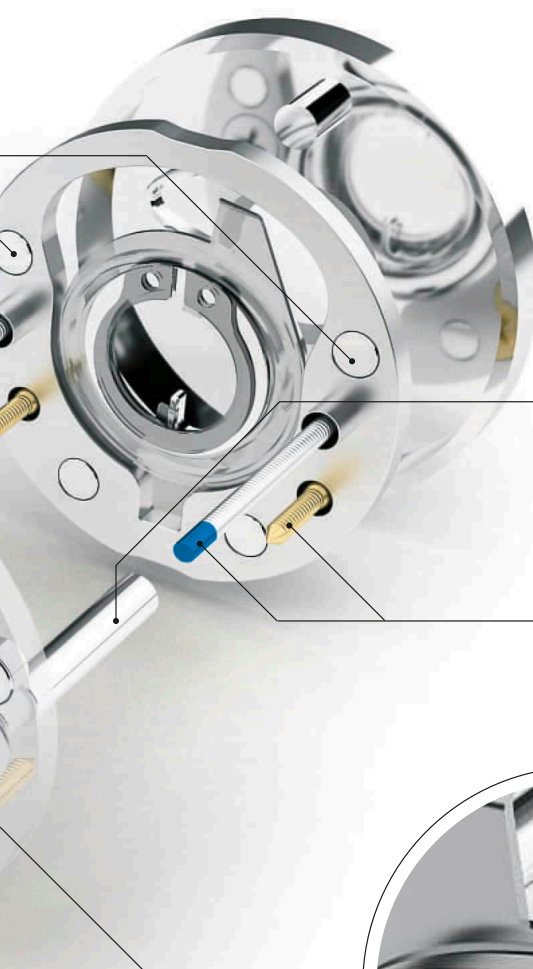

**SYSTÉM PROŠROUBOVÁNÍ  
BEZ MOŽNOSTI POTOČENÍ ROZET**  
přesné naváděcí válečky/pouzdra nasazené  
do předvrtaných otvorů ve dveřích zabrání  
jakémukoliv pohybu celé konstrukce rozet



**SYSTÉM FIXACE ŠROUBY TUFLOK®**  
s otěruvzdorným nylonovým povlakem dlouhodobě  
garantuje stabilitu celé konstrukce bez možnosti  
samovolného uvolnění + nabízí další 4 jistící body  
pomocí samořezných vrtů



**SYSTÉM 1 SPRING**  
optimální síly stlačení na kliku je dosaženo  
vratnou pružinou montážně připravenou  
pouze na jedné klice, další funkčnost  
zajišťuje dveřní zámek



**SYSTÉM  
KLUZNÝCH POUZDER**  
polymerová kluzná pouzdra precizně vedou  
kliky v rozetě a dlouhodobě zajišťují jejich tichý  
a bezvadný chod

**Mechanika 2018  
MAGNETIC system**

34 komponent

6 zásadních inovací

1 dokonalý celek



vrtání otvorů  
pro magnetické rozety

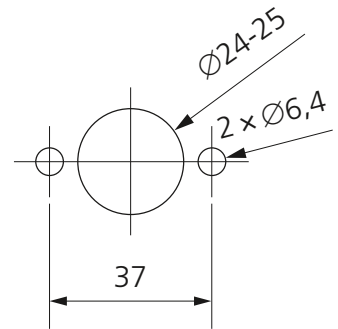

Celý projekt - jeden design

Klíky + magnetické rozety



Klíky a zámky na skleněné dveře



Madla a koule na skleněné  
a dřevěné dveře



Hranaté panty na dřevěné  
dveře



Okenní klíky  
3 a 4 polohové



Bezpečnostní madla  
Entero



Madla dlouhá



Kování pro hliníkové a ocelové dveře,  
kování na branky



Panty na skleněné dveře



Mušle na posuvné  
dveře



Bezpečnostní rozety



## Kliky + magnetické rozety DESIGN 2017

Materiál rozet: magnetická nerez ocel

Materiál klik: masivní mosaz

Povrchy: SNI, Cr, TiN-C, TiN-K, Ms, Ms-L, Ms-A, zakázkově TiN-A  
více info na [www.kliky-mt.cz/manufaktura/barvy-povrchy](http://www.kliky-mt.cz/manufaktura/barvy-povrchy)

Konstrukce, mechanika: magnetické rozety s 1 vratnou pružinou, mechanika M2018

Nejdokonalejší a nejrychlejší systém montáže. Účinný systém, který dlouhodobě pevně fixuje kličky a MG rozety k dveřnímu křídle bez možnosti jakéhokoliv pohybu rozet po dveřním křídle, bez možnosti poškrábání dveří. Tloušťka pouhých 5 mm předurčuje MG rozety ke kombinaci jak s projektovými, tak s designovými řadami dveřních klik.

### SOGUT Ms-A mosaz antik

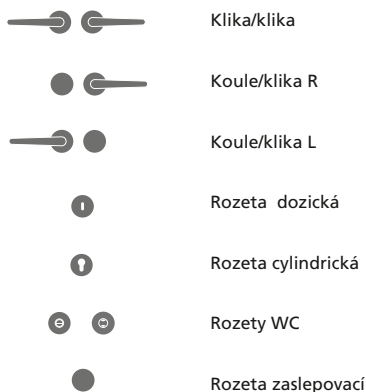

magnetické rozety Ø 54 mm, tl. 5 mm



koule Maty

### ENTERO Cr lesklý chrom

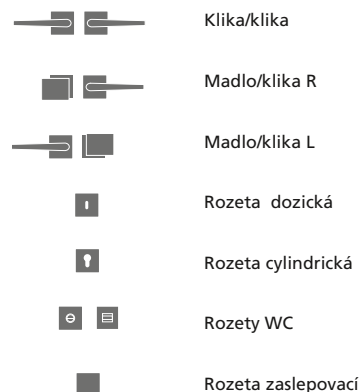

magnetické rozety 54x54 mm, tl. 5 mm



madlo Entero

#### konstrukční varianty, materiálové provedení

- set kování s 1 vratnou pružinou
- standardně bez spodních rozet
- spodní rozety se objednávají samostatně
- sešroubování pouzdry proti sobě
- použité systémy viz. předcházející dvojstrana
- příprava do dveří: vrtání otvoru průměr 24 – 25mm
- kličky s MG rozetami lze plně zapustit do dveří, pozor na zeslabenou stranu u falcových a reversních dveří. Prostor/hloubka zapuštění pro MG rozety včetně vratné pružiny a krčku kličky je 8,5 mm
- zajišťovací gel proti uvolnění červíků
- vrtání PROFÍ šablonou M&T vrtákem Ø 6,4 mm
- montáž pro tloušťky dveří 38 – 126 mm
- možnost dodání v protipožárním provedení
- v balení standardně montážní materiál pro tl. dveří 38 - 45 mm
- záruka 3 roky, titany 15 let

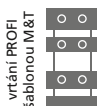

roky **3 garance** let **15 garance**

Ochranná známka – registrovaná značka

**ENTERO®**



Chráněné průmyslové vzory klik



**ENTERO**  
**BURAK**  
**MIA**  
**SOGUT**



SNI matný nikel

**Cesan**

1660,- Kč  
70,- EUR

**KČ** materiál: masivní mosaz  
povrch: SNI matný nikel **EUR**

1660,-		70,-
2490,-		104,-
2490,-		104,-



TiN-K titan černý mat

**Cesan**

2920,- Kč  
122,- EUR

**KČ** materiál: masivní mosaz  
povrch: TiN-K titan černý mat **EUR**

2920,-		122,-
3890,-		163,-
3890,-		163,-

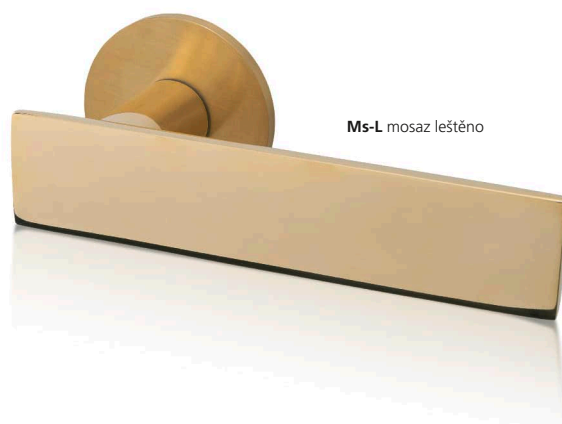

Ms-L mosaz leštěno

**Entero**

3140,- Kč  
131,- EUR

**KČ** materiál: masivní mosaz  
povrch: Ms-L mosaz leštěno **EUR**

3140,-		131,-
3970,-		166,-
3970,-		166,-



TiN-K titan černý mat

**Entero**

3810,- Kč  
159,- EUR

**KČ** materiál: masivní mosaz  
povrch: TiN-K titan černý mat **EUR**

3810,-		159,-
4780,-		200,-
4780,-		200,-



Magnetická rozeta											
		SNI		Cr		Ms		Ms-L		Ms-A	
		cena / pár	EAN	cena / pár	EAN	cena / pár	EAN	cena / pár	EAN	cena / pár	EAN
klika / klika	Kč €	1660,- 70,-	097153	1980,- 83,-	097160	2260,- 95,-	097177	2260,- 95,-	097184	2380,- 100,-	097191
koule / klika R	Kč €	2490,- 104,-	097207	2790,- 117,-	097214	3060,- 128,-	097221	3060,- 128,-	097238	3200,- 134,-	097245
koule / klika L	Kč €	2490,- 104,-	097252	2790,- 117,-	097269	3060,- 128,-	097276	3060,- 128,-	097283	3200,- 134,-	097290

U povrchů Ms, Ms-L, Ms-A je vždy rozeta pod klikou, spodní zámkové rozety, WC mechanismus v matném „zlatém provedení“ tj. povrch TiN-A.

Magnetická rozeta											
		TiN-A		TiN-C		TiN-B		TiN-K		Cr-K	
		cena / pár	EAN	cena / pár	EAN	cena / pár	EAN	cena / pár	EAN	cena / pár	EAN
klika / klika	Kč €	2920,- 122,-	097306	2920,- 122,-	097313	2920,- 122,-	097320	2920,- 122,-	097337	3210,- 134,-	097344
koule / klika R	Kč €	3890,- 163,-	097351	3890,- 163,-	097368	3890,- 163,-	097375	3890,- 163,-	097382	4280,- 179,-	097399
koule / klika L	Kč €	3890,- 163,-	097405	3890,- 163,-	097412	3890,- 163,-	097429	3890,- 163,-	097436	4280,- 179,-	097443



Magnetická rozeta											
		SNI		Cr		Ms		Ms-L		Ms-A	
		cena / pár	EAN	cena / pár	EAN	cena / pár	EAN	cena / pár	EAN	cena / pár	EAN
klika / klika	Kč €	2570,- 108,-	098952	2870,- 120,-	098969	3140,- 131,-	098976	3140,- 131,-	098983	3280,- 137,-	098990
koule / klika R	Kč €	3400,- 142,-	099003	3710,- 155,-	099010	3970,- 166,-	099027	3970,- 166,-	099034	4120,- 172,-	099041
koule / klika L	Kč €	3400,- 142,-	099058	3710,- 155,-	099065	3970,- 166,-	099072	3970,- 166,-	099089	4120,- 172,-	099096

U povrchů Ms, Ms-L, Ms-A je vždy rozeta pod klikou, spodní zámkové rozety, WC mechanismus v matném „zlatém provedení“ tj. povrch TiN-A.

Magnetická rozeta											
		TiN-A		TiN-C		TiN-B		TiN-K		Cr-K	
		cena / pár	EAN	cena / pár	EAN	cena / pár	EAN	cena / pár	EAN	cena / pár	EAN
klika / klika	Kč €	3810,- 159,-	099102	3810,- 159,-	099119	3810,- 159,-	099126	3810,- 159,-	099133	4180,- 175,-	099140
koule / klika R	Kč €	4780,- 200,-	099157	4780,- 200,-	099164	4780,- 200,-	099171	4780,- 200,-	099188	5260,- 220,-	099195
koule / klika L	Kč €	4780,- 200,-	099201	4780,- 200,-	099218	4780,- 200,-	099225	4780,- 200,-	099232	5260,- 220,-	099249



Cr lesklý chrom

**Burak**

2090,- Kč  
88,- EUR

**KČ** materiál: masivní mosaz  
povrch: Cr lesklý chrom **EUR**

2090,-		88,-
2920,-		122,-
2920,-		122,-



Cr-K černý chrom natural

**Burak**

3320,- Kč  
139,- EUR

**KČ** materiál: masivní mosaz  
povrch: Cr-K černý chrom natural **EUR**

3320,-		139,-
4380,-		183,-
4380,-		183,-



SNi matný nikel

**Andy**

1940,- Kč  
81,- EUR

**KČ** materiál: masivní mosaz  
povrch: SNi matný nikel **EUR**

1940,-		81,-
2760,-		115,-
2760,-		115,-



TiN-A titan mosaz mat

**Andy**

3190,- Kč  
133,- EUR

**KČ** materiál: masivní mosaz  
povrch: TiN-A titan mosaz mat **EUR**

3190,-		133,-
4150,-		173,-
4150,-		173,-





Magnetická rozeta											
		SNI		Cr		Ms		Ms-L		Ms-A	
		cena / pár	EAN	cena / pár	EAN	cena / pár	EAN	cena / pár	EAN	cena / pár	EAN
klika / klika	Kč €	1770,- 74,-	097757	2090,- 88,-	097764	2360,- 99,-	097771	2360,- 99,-	097788	2490,- 104,-	097795
koule / klika R	Kč €	2590,- 108,-	097801	2920,- 122,-	097818	3190,- 133,-	097825	3190,- 133,-	097832	3310,- 138,-	097849
koule / klika L	Kč €	2590,- 108,-	097856	2920,- 122,-	097863	3190,- 133,-	097870	3190,- 133,-	097887	3310,- 138,-	097894

U povrchů Ms, Ms-L, Ms-A je vždy rozeta pod klikou, spodní zámkové rozety, WC mechanismus v matném „zlatém provedení“ tj. povrch TiN-A.

Magnetická rozeta											
		TiN-A		TiN-C		TiN-B		TiN-K		Cr-K	
		cena / pár	EAN	cena / pár	EAN	cena / pár	EAN	cena / pár	EAN	cena / pár	EAN
klika / klika	Kč €	3020,- 126,-	097900	3020,- 126,-	097917	3020,- 126,-	097924	3020,- 126,-	097931	3320,- 139,-	097948
koule / klika R	Kč €	3990,- 167,-	097955	3990,- 167,-	097962	3990,- 167,-	097979	3990,- 167,-	097986	4380,- 183,-	097993
koule / klika L	Kč €	3990,- 167,-	098006	3990,- 167,-	098013	3990,- 167,-	098020	3990,- 167,-	098037	4380,- 183,-	098044



Magnetická rozeta											
		SNI		Cr		Ms		Ms-L		Ms-A	
		cena / pár	EAN	cena / pár	EAN	cena / pár	EAN	cena / pár	EAN	cena / pár	EAN
klika / klika	Kč €	1940,- 81,-	098051	2260,- 95,-	098068	2510,- 105,-	098075	2510,- 105,-	098082	2650,- 111,-	098099
koule / klika R	Kč €	2760,- 115,-	098105	3060,- 128,-	098112	3320,- 139,-	098129	3320,- 139,-	098136	3450,- 144,-	098143
koule / klika L	Kč €	2760,- 115,-	098150	3060,- 128,-	098167	3320,- 139,-	098174	3320,- 139,-	098181	3450,- 144,-	098198

U povrchů Ms, Ms-L, Ms-A je vždy rozeta pod klikou, spodní zámkové rozety, WC mechanismus v matném „zlatém provedení“ tj. povrch TiN-A.

Magnetická rozeta											
		TiN-A		TiN-C		TiN-B		TiN-K		Cr-K	
		cena / pár	EAN	cena / pár	EAN	cena / pár	EAN	cena / pár	EAN	cena / pár	EAN
klika / klika	Kč €	3190,- 133,-	098204	3190,- 133,-	098211	3190,- 133,-	098228	3190,- 133,-	098235	3500,- 146,-	098242
koule / klika R	Kč €	4150,- 173,-	098259	4150,- 173,-	098266	4150,- 173,-	098273	4150,- 173,-	098280	4570,- 191,-	098297
koule / klika L	Kč €	4150,- 173,-	098303	4150,- 173,-	098310	4150,- 173,-	098327	4150,- 173,-	098334	4570,- 191,-	098341



Ms-A mosaz antik

**Sogut**

2760,- Kč  
115,- EUR

Kč	materiál: masivní mosaz povrch: Ms-A mosaz antik	EUR
2760,-		115,-
3600,-		150,-
3600,-		150,-



Cr-K černý chrom natural

**Sogut**

3620,- Kč  
151,- EUR

Kč	materiál: masivní mosaz povrch: Cr-K černý chrom natural	EUR
3620,-		151,-
4700,-		196,-
4700,-		196,-

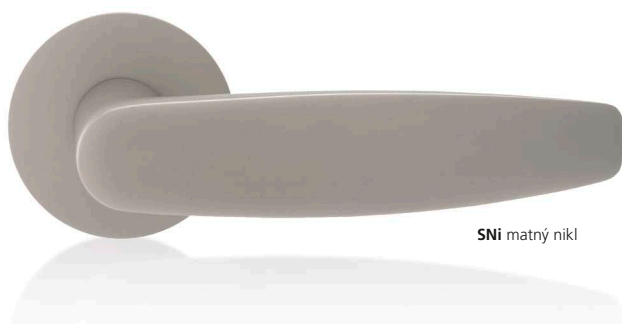

SNi matný nikel

**Cherez**

2510,- Kč  
105,- EUR

Kč	materiál: masivní mosaz povrch: SNi matný nikel	EUR
2510,-		105,-
3620,-		151,-
3620,-		151,-

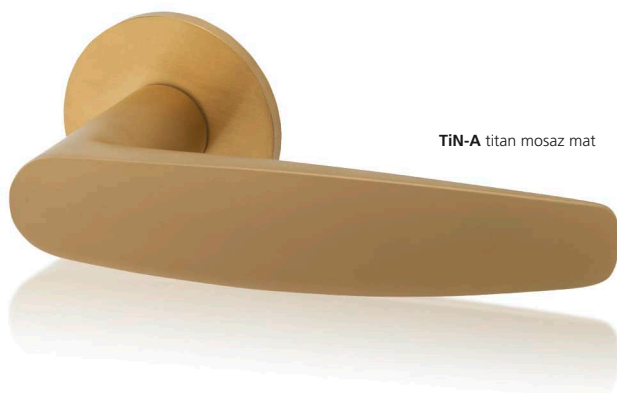

TiN-A titan mosaz mat

**Cherez**

3750,- Kč  
157,- EUR

Kč	materiál: masivní mosaz povrch: TiN-A titan mosaz mat	EUR
3750,-		157,-
5010,-		209,-
5010,-		209,-



Magnetická rozeta											
		SNI		Cr		Ms		Ms-L		Ms-A	
		cena / pár	EAN	cena / pár	EAN	cena / pár	EAN	cena / pár	EAN	cena / pár	EAN
klika / klika	Kč €	2050,- 86,-	098358	2360,- 99,-	098365	2610,- 109,-	098372	2610,- 109,-	098389	2760,- 115,-	098396
koule / klika R	Kč €	2880,- 120,-	098402	3200,- 134,-	098419	3450,- 144,-	098426	3450,- 144,-	098433	3600,- 150,-	098440
koule / klika L	Kč €	2880,- 120,-	098457	3200,- 134,-	098464	3450,- 144,-	098471	3450,- 144,-	098488	3600,- 150,-	098495

U povrchů Ms, Ms-L, Ms-A je vždy rozeta pod klikou, spodní zámkové rozety, WC mechanismus v matném „zlatém provedení“ tj. povrch TiN-A.

Magnetická rozeta											
		TiN-A		TiN-C		TiN-B		TiN-K		Cr-K	
		cena / pár	EAN	cena / pár	EAN	cena / pár	EAN	cena / pár	EAN	cena / pár	EAN
klika / klika	Kč €	3290,- 138,-	098501	3290,- 138,-	098518	3290,- 138,-	098525	3290,- 138,-	098532	3620,- 151,-	098549
koule / klika R	Kč €	4270,- 178,-	098556	4270,- 178,-	098563	4270,- 178,-	098570	4270,- 178,-	098587	4700,- 196,-	098594
koule / klika L	Kč €	4270,- 178,-	098600	4270,- 178,-	098617	4270,- 178,-	098624	4270,- 178,-	098631	4700,- 196,-	098648



Magnetická rozeta											
		SNI		Cr		Ms		Ms-L		Ms-A	
		cena / pár	EAN	cena / pár	EAN	cena / pár	EAN	cena / pár	EAN	cena / pár	EAN
klika / klika	Kč €	2510,- 105,-	098655	2820,- 118,-	098662	3080,- 129,-	098679	3080,- 129,-	098686	3220,- 135,-	098693
koule / klika R	Kč €	3620,- 151,-	098709	3920,- 164,-	098716	3450,- 144,-	098723	4180,- 175,-	098730	4330,- 181,-	098747
koule / klika L	Kč €	3620,- 151,-	098754	3920,- 164,-	098761	3450,- 144,-	098778	4180,- 175,-	098785	4330,- 181,-	098792

U povrchů Ms, Ms-L, Ms-A je vždy rozeta pod klikou, spodní zámkové rozety, WC mechanismus v matném „zlatém provedení“ tj. povrch TiN-A.

Magnetická rozeta											
		TiN-A		TiN-C		TiN-B		TiN-K		Cr-K	
		cena / pár	EAN	cena / pár	EAN	cena / pár	EAN	cena / pár	EAN	cena / pár	EAN
klika / klika	Kč €	3750,- 157,-	098808	3750,- 157,-	098815	3750,- 157,-	098822	3750,- 157,-	098839	4140,- 173,-	098846
koule / klika R	Kč €	5010,- 209,-	098853	5010,- 209,-	098860	5010,- 209,-	098877	5010,- 209,-	098884	5520,- 230,-	098891
koule / klika L	Kč €	5010,- 209,-	098907	5010,- 209,-	098914	5010,- 209,-	098921	5010,- 209,-	098938	5520,- 230,-	098945



Cr lesklý chrom

**Deny**

2090,- Kč  
88,- EUR

Kč	materiál: masivní mosaz povrch: Cr lesklý chrom	EUR
2090,-		88,-
2920,-		122,-
2920,-		122,-



TiN-K titan černý mat

**Deny**

3020,- Kč  
126,- EUR

Kč	materiál: masivní mosaz povrch: TiN-K titan černý mat	EUR
3020,-		126,-
3990,-		167,-
3990,-		167,-

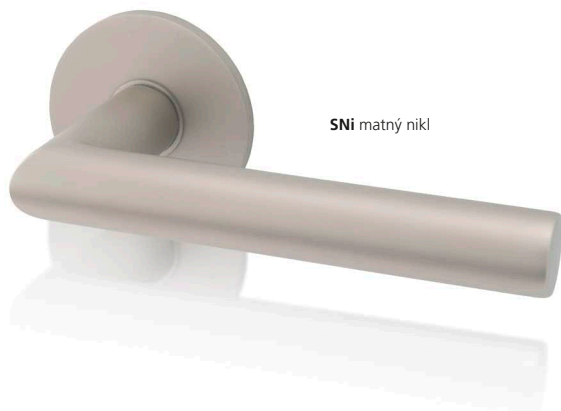

SNi matný nikl

**Lusy**

1770,- Kč  
74,- EUR

Kč	materiál: masivní mosaz povrch: SNi matný nikl	EUR
1770,-		74,-
2590,-		108,-
2590,-		108,-



TiN-A titan mosaz mat

**Lusy**

3020,- Kč  
126,- EUR

Kč	materiál: masivní mosaz povrch: TiN-A titan mosaz mat	EUR
3020,-		126,-
3990,-		167,-
3990,-		167,-



Magnetická rozeta											
		SNI		Cr		Ms		Ms-L		Ms-A	
		cena / pár	EAN	cena / pár	EAN	cena / pár	EAN	cena / pár	EAN	cena / pár	EAN
klika / klika	Kč €	1770,- 74,-	099553	2090,- 88,-	099560	2360,- 99,-	099577	2360,- 99,-	099584	2490,- 104,-	099591
koule / klika R	Kč €	2590,- 108,-	099607	2920,- 122,-	099614	3190,- 133,-	099621	3190,- 133,-	099638	3310,- 138,-	099645
koule / klika L	Kč €	2590,- 108,-	099652	2920,- 122,-	099669	3190,- 133,-	099676	3190,- 133,-	099683	3310,- 138,-	099690

U povrchů Ms, Ms-L, Ms-A je vždy rozeta pod klikou, spodní zámkové rozety, WC mechanismus v matném „zlatém provedení“ tj. povrch TiN-A.

Magnetická rozeta											
		TiN-A		TiN-C		TiN-B		TiN-K		Cr-K	
		cena / pár	EAN	cena / pár	EAN	cena / pár	EAN	cena / pár	EAN	cena / pár	EAN
klika / klika	Kč €	3020,- 126,-	099706	3020,- 126,-	099713	3020,- 126,-	099720	3020,- 126,-	099737	3320,- 139,-	099744
koule / klika R	Kč €	3990,- 167,-	099751	3990,- 167,-	099768	3990,- 167,-	099775	3990,- 167,-	099782	4380,- 183,-	099799
koule / klika L	Kč €	3990,- 167,-	099805	3990,- 167,-	099812	3990,- 167,-	099829	3990,- 167,-	099836	4380,- 183,-	099843



Magnetická rozeta											
		SNI		Cr		Ms		Ms-L		Ms-A	
		cena / pár	EAN	cena / pár	EAN	cena / pár	EAN	cena / pár	EAN	cena / pár	EAN
klika / klika	Kč €	1770,- 74,-	095289	2090,- 88,-	095296	2360,- 99,-	101058	2360,- 99,-	101065	2490,- 104,-	101072
koule / klika R	Kč €	2590,- 108,-	095340	2920,- 122,-	095357	3190,- 133,-	101089	3190,- 133,-	101096	3310,- 138,-	101102
koule / klika L	Kč €	2590,- 108,-	095401	2920,- 122,-	095418	3190,- 133,-	101119	3190,- 133,-	101126	3310,- 138,-	101133

U povrchů Ms, Ms-L, Ms-A je vždy rozeta pod klikou, spodní zámkové rozety, WC mechanismus v matném „zlatém provedení“ tj. povrch TiN-A.

Magnetická rozeta											
		TiN-A		TiN-C		TiN-B		TiN-K		Cr-K	
		cena / pár	EAN	cena / pár	EAN	cena / pár	EAN	cena / pár	EAN	cena / pár	EAN
klika / klika	Kč €	3020,- 126,-	095302	3020,- 126,-	095319	3020,- 126,-	095326	3020,- 126,-	095333	3320,- 139,-	101232
koule / klika R	Kč €	3990,- 167,-	095364	3990,- 167,-	095371	3990,- 167,-	095388	3990,- 167,-	095395	4380,- 183,-	101249
koule / klika L	Kč €	3990,- 167,-	095425	3990,- 167,-	095432	3990,- 167,-	095449	3990,- 167,-	095456	4380,- 183,-	101256



SNi matný nikel

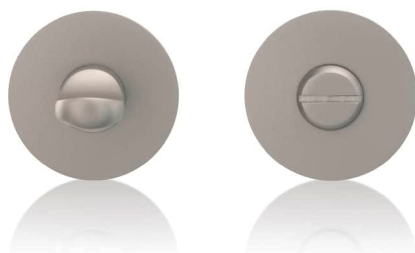

**Spodní rozety**

670,- Kč  
28,- EUR

materiál: magnetická nerez ocel  
Kč povrch: SNi matný nikel EUR

Kč		EUR
670,-	ⓘ	28,-
670,-	Ⓜ	28,-
1140,-	Ⓧ	48,-
800,-	●	34,-

**Spodní rozety**

1260,- Kč  
53,- EUR

materiál: magnetická nerez ocel  
Kč povrch: TiN-C titan chrom mat EUR

Kč		EUR
1260,-	ⓘ	53,-
1260,-	Ⓜ	53,-
1860,-	Ⓧ	78,-
1400,-	●	59,-



		Magnetická rozeta							
		SNI		K-industrial		Cr		TiN-A	
		cena / pár	EAN	cena / pár	EAN	cena / pár	EAN	cena / pár	EAN
dozické	Kč €	670,- 28,-	095647	1000,- 42,-	140255	790,- 33,-	095654	1000,- 42,-	095661
cyklindrické	Kč €	670,- 28,-	095708	1000,- 42,-	140262	790,- 33,-	095715	1000,- 42,-	095722
WC	Kč €	1140,- 48,-	095760	1460,- 61,-	140279	1340,- 56,-	095777	1460,- 61,-	095784
zaslepovací	Kč €	800,- 34,-	101140	1140,- 48,-	140286	920,- 39,-	101157	1140,- 48,-	104899

Spodní rozety v matném „zlatém provedení“ TiN-A se dodávají ke klikám v povrchu Ms-A, Ms-L, Ms.

		Magnetická rozeta							
		TiN-C		TiN-B		TiN-K		Cr-K	
		cena / pár	EAN	cena / pár	EAN	cena / pár	EAN	cena / pár	EAN
dozické	Kč €	1260,- 53,-	095678	1260,- 53,-	095685	1000,- 42,-	091601	1250,- 53,-	101263
cyklindrické	Kč €	1260,- 53,-	095739	1260,- 53,-	095746	1000,- 42,-	091618	1250,- 53,-	101270
WC	Kč €	1860,- 78,-	095791	1860,- 78,-	095807	1460,- 61,-	091625	1750,- 73,-	101287
zaslepovací	Kč €	1400,- 59,-	104905	1400,- 59,-	104882	1140,- 48,-	104875	1390,- 58,-	101164





SNi matný nikel

**Lusy**

2200,- Kč  
92,- EUR

Kč	materiál: masivní mosaz povrch: SNi matný nikel	EUR
2200,-		92,-
3300,-		138,-
3300,-		138,-

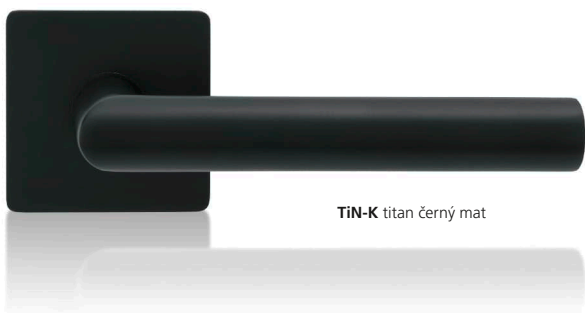

TiN-K titan černý mat

**Lusy**

3440,- Kč  
144,- EUR

Kč	materiál: masivní mosaz povrch: TiN-K titan černý mat	EUR
3440,-		144,-
4700,-		196,-
4700,-		196,-



Cr lesklý chrom

**Deny**

2510,- Kč  
105,- EUR

Kč	materiál: masivní mosaz povrch: Cr lesklý chrom	EUR
2510,-		105,-
3620,-		151,-
3620,-		151,-



TiN-K titan černý mat

**Deny**

3440,- Kč  
144,- EUR

Kč	materiál: masivní mosaz povrch: TiN-K titan černý mat	EUR
3440,-		144,-
4700,-		196,-
4700,-		196,-





Magnetická rozeta											
		SNI		Cr		Ms		Ms-L		Ms-A	
		cena / pár	EAN	cena / pár	EAN	cena / pár	EAN	cena / pár	EAN	cena / pár	EAN
klika / klika	Kč €	2200,- 92,-	095463	2510,- 105,-	095470	2780,- 116,-	101294	2780,- 116,-	101300	2920,- 122,-	101317
madlo / klika R	Kč €	3300,- 138,-	095524	3620,- 151,-	095531	3890,- 163,-	101324	3890,- 163,-	101331	4030,- 168,-	101348
madlo / klika L	Kč €	3300,- 138,-	095586	3620,- 151,-	095593	3890,- 163,-	101355	3890,- 163,-	101362	4030,- 168,-	101379

U povrchů Ms, Ms-L, Ms-A je vždy rozeta pod klikou a spodní rozety + WC mechanismus v matném „zlatém provedení“ tj. povrch TiN-A.

Magnetická rozeta											
		TiN-A		TiN-C		TiN-B		TiN-K		Cr-K	
		cena / pár	EAN	cena / pár	EAN	cena / pár	EAN	cena / pár	EAN	cena / pár	EAN
klika / klika	Kč €	3440,- 144,-	095487	3440,- 144,-	095494	3440,- 144,-	095500	3440,- 144,-	095517	3800,- 159,-	101478
madlo / klika R	Kč €	4700,- 196,-	095548	4700,- 196,-	095555	4700,- 196,-	095562	4700,- 196,-	095579	5180,- 216,-	101485
madlo / klika L	Kč €	4700,- 196,-	095609	4700,- 196,-	095616	4700,- 196,-	095623	4700,- 196,-	095630	5180,- 216,-	101492



Magnetická rozeta											
		SNI		Cr		Ms		Ms-L		Ms-A	
		cena / pár	EAN	cena / pár	EAN	cena / pár	EAN	cena / pár	EAN	cena / pár	EAN
klika / klika	Kč €	2200,- 92,-	100150	2510,- 105,-	100167	2780,- 116,-	100174	2780,- 116,-	100181	2920,- 122,-	100198
madlo / klika R	Kč €	3300,- 138,-	100204	3620,- 151,-	100211	3890,- 163,-	100228	3890,- 163,-	100235	4030,- 168,-	100242
madlo / klika L	Kč €	3300,- 138,-	100259	3620,- 151,-	100266	3890,- 163,-	100273	3890,- 163,-	100280	4030,- 168,-	100297

U povrchů Ms, Ms-L, Ms-A je vždy rozeta pod klikou a spodní rozety + WC mechanismus v matném „zlatém provedení“ tj. povrch TiN-A.

Magnetická rozeta											
		TiN-A		TiN-C		TiN-B		TiN-K		Cr-K	
		cena / pár	EAN	cena / pár	EAN	cena / pár	EAN	cena / pár	EAN	cena / pár	EAN
klika / klika	Kč €	3440,- 144,-	100303	3440,- 144,-	100310	3440,- 144,-	100327	3440,- 144,-	100334	3800,- 159,-	100341
madlo / klika R	Kč €	4700,- 196,-	100358	4700,- 196,-	100365	4700,- 196,-	100372	4700,- 196,-	100389	5180,- 216,-	100396
madlo / klika L	Kč €	4700,- 196,-	100402	4700,- 196,-	100419	4700,- 196,-	100426	4700,- 196,-	100433	5180,- 216,-	100440



SNi matný nikel

**Sogut**

2650,- Kč  
111,- EUR

Kč	materiál: masivní mosaz povrch: SNi matný nikel	EUR
2650,-		111,-
3720,-		155,-
3720,-		155,-



TiN-K titan černý mat

**Sogut**

3890,- Kč  
163,- EUR

Kč	materiál: masivní mosaz povrch: TiN-K titan černý mat	EUR
3890,-		163,-
5120,-		214,-
5120,-		214,-

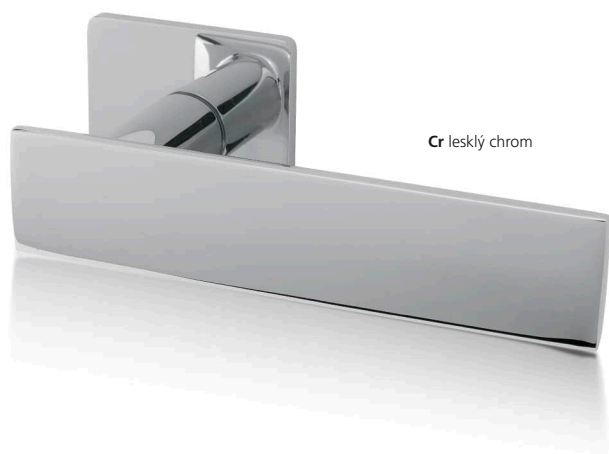

Cr lesklý chrom

**Entero**

3480,- Kč  
145,- EUR

Kč	materiál: masivní mosaz povrch: Cr lesklý chrom	EUR
3480,-		145,-
4550,-		190,-
4550,-		190,-



TiN-K titan černý mat

**Entero**

4400,- Kč  
184,- EUR

Kč	materiál: masivní mosaz povrch: TiN-K titan černý mat	EUR
4400,-		184,-
5630,-		235,-
5630,-		235,-



Magnetická rozeta											
		SNI		Cr		Ms		Ms-L		Ms-A	
		cena / pár	EAN	cena / pár	EAN	cena / pár	EAN	cena / pár	EAN	cena / pár	EAN
klika / klika	Kč €	2650,- 111,-	100457	2960,- 124,-	100464	3220,- 135,-	100471	3220,- 135,-	100488	3360,- 140,-	100495
madlo / klika R	Kč €	3720,- 155,-	100501	4040,- 169,-	100518	4310,- 180,-	100525	4310,- 180,-	100532	4430,- 185,-	100549
madlo / klika L	Kč €	3720,- 155,-	100556	4040,- 169,-	100563	4310,- 180,-	100570	4310,- 180,-	100587	4430,- 185,-	100594

U povrchů Ms, Ms-L, Ms-A je vždy rozeta pod klikou a spodní rozety + WC mechanismus v matném „zlatém provedení“ tj. povrch TiN-A.

Magnetická rozeta											
		TiN-A		TiN-C		TiN-B		TiN-K		Cr-K	
		cena / pár	EAN	cena / pár	EAN	cena / pár	EAN	cena / pár	EAN	cena / pár	EAN
klika / klika	Kč €	3890,- 163,-	100600	3890,- 163,-	100617	3890,- 163,-	100624	3890,- 163,-	100631	4280,- 179,-	100648
madlo / klika R	Kč €	5120,- 214,-	100655	5120,- 214,-	100662	5120,- 214,-	100679	5120,- 214,-	100686	5640,- 235,-	100693
madlo / klika L	Kč €	5120,- 214,-	100709	5120,- 214,-	100716	5120,- 214,-	100723	5120,- 214,-	100730	5640,- 235,-	100747



Magnetická rozeta											
		SNI		Cr		Ms		Ms-L		Ms-A	
		cena / pár	EAN	cena / pár	EAN	cena / pár	EAN	cena / pár	EAN	cena / pár	EAN
klika / klika	Kč €	3170,- 133,-	100754	3480,- 145,-	100761	3730,- 156,-	100778	3730,- 156,-	100785	3870,- 162,-	100792
madlo / klika R	Kč €	4240,- 177,-	100808	4550,- 190,-	100815	4810,- 201,-	100822	4810,- 201,-	100839	4960,- 207,-	100846
madlo / klika L	Kč €	4240,- 177,-	100853	4550,- 190,-	100860	4810,- 201,-	100877	4810,- 201,-	100884	4960,- 207,-	100891

U povrchů Ms, Ms-L, Ms-A je vždy rozeta pod klikou a spodní rozety + WC mechanismus v matném „zlatém provedení“ tj. povrch TiN-A.

Magnetická rozeta											
		TiN-A		TiN-C		TiN-B		TiN-K		Cr-K	
		cena / pár	EAN	cena / pár	EAN	cena / pár	EAN	cena / pár	EAN	cena / pár	EAN
klika / klika	Kč €	4400,- 184,-	100907	4400,- 184,-	100914	4400,- 184,-	100921	4400,- 184,-	100938	4840,- 202,-	100945
madlo / klika R	Kč €	5630,- 235,-	100952	5630,- 235,-	100969	5630,- 235,-	100976	5630,- 235,-	100983	6200,- 259,-	100990
madlo / klika L	Kč €	5630,- 235,-	101003	5630,- 235,-	101010	5630,- 235,-	101027	5630,- 235,-	101034	6200,- 259,-	101041



SNi matný nikel



**Spodní rozety**

790,- Kč  
33,- EUR

materiál: magnetická nerez ocel  
Kč povrch: SNi matný nikel EUR

790,-		33,-
790,-		33,-
1320,-		55,-
920,-		39,-

**Spodní rozety**

1390,- Kč  
58,- EUR

materiál: magnetická nerez ocel  
Kč povrch: TiN-C titan chrom mat EUR

1390,-		58,-
1390,-		58,-
2050,-		86,-
1520,-		64,-



		Magnetická rozeta							
		SNI		K-industrial		Cr		TiN-A	
		cena / pár	EAN	cena / pár	EAN	cena / pár	EAN	cena / pár	EAN
dozické	Kč €	790,- 33,-	095821	1110,- 47,-	140293	930,- 39,-	095838	1110,- 47,-	095845
cyklindrické	Kč €	790,- 33,-	095883	1110,- 47,-	140309	930,- 39,-	095890	1110,- 47,-	095906
WC	Kč €	1320,- 55,-	095944	1650,- 69,-	140316	1550,- 65,-	095951	1650,- 69,-	095968
zaslepovací	Kč €	920,- 39,-	101171	1250,- 53,-	140323	1070,- 45,-	101188	1250,- 53,-	105070

Spodní rozety v matném „zlatém provedení“ TiN-A se dodávají ke klikám v povrchu Ms-A, Ms-L, Ms.

		Magnetická rozeta							
		TiN-C		TiN-B		TiN-K		Cr-K	
		cena / pár	EAN	cena / pár	EAN	cena / pár	EAN	cena / pár	EAN
dozické	Kč €	1390,- 58,-	095852	1390,- 58,-	095869	1110,- 47,-	093582	1390,- 58,-	101508
cyklindrické	Kč €	1390,- 58,-	095913	1390,- 58,-	095920	1110,- 47,-	093599	1390,- 58,-	101515
WC	Kč €	2050,- 86,-	095975	2050,- 86,-	095982	1650,- 69,-	093605	1960,- 82,-	101522
zaslepovací	Kč €	1520,- 64,-	105087	1520,- 64,-	105063	1250,- 53,-	105056	1520,- 64,-	101195



## System plochých a zapuštěných rozet

Univerzální konstrukce umožňuje montáž klik s magnetickou rozetou buď přisazením na dveřní křídlo tj. systém plochých rozet nebo vložení/zafrezováním do dveřního křídla tj. systém zcela zapuštěných rozet.



Při montáži systémem zapuštěných rozet si před výrobou dveří ověřte vhodnost/možnost zapuštění magnetických rozet do stěny dveřního křídla s ohledem na umístění dveřního zámku u falcových a reversních dveří.



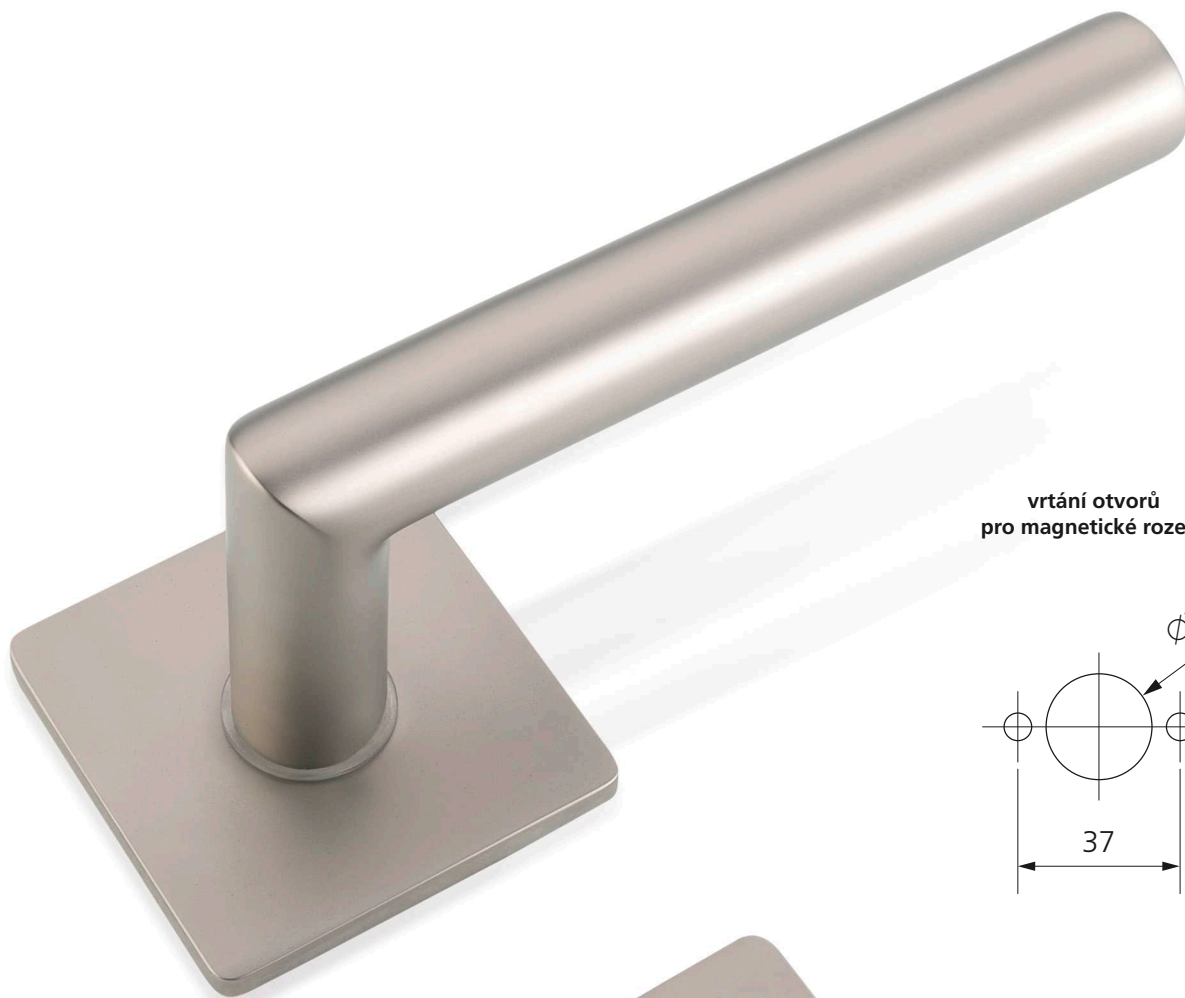

vrtní otvorů  
pro magnetické rozety

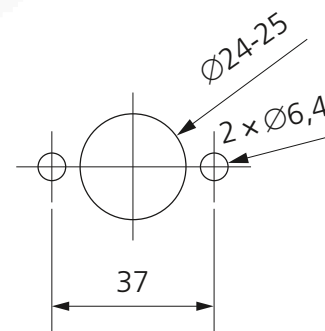



Celý projekt - jeden design

Dveřní kliky, madla



Kliky a zámky na skleněné dveře



Kliky a madla pro hliníkové a ocelové dveře



Panty na skleněné dveře



Okenní kliky 3-polohové



Bezpečnostní rozety





## Dveřní kliky DESIGN 2018 Rocksor

Design: Stanislav Fiala

Materiál: masivní mosaz

Povrchy: Ms-A, Ms-K, Ms-L, TiN-C, TiN-K, K-industrial  
více info na [www.kliky-mt.cz/manufaktura/barvy-povrchy](http://www.kliky-mt.cz/manufaktura/barvy-povrchy)

Konstrukce, mechanika: magnetické rozety, mechanika M2018

ROCKSOR **TiN-K** titan černý mat



ROCKSOR **Ms-A** mosaz antik



Klika/klika + magnetické rozety



Madlo/klika R + magnetické rozety



Madlo/klika L + magnetické rozety



Rozety dozické



Rozety cylindrické



Rozety WC



Rozety zaslepovací



dozické



cylindrické



zaslepovací



WC ex



WC in



madlo Rocksor

magnetické rozety Ø 54 mm, tl. 5 mm

### konstrukční varianty, materiálové provedení

- designová sada standardně bez spodních rozet
- spodní rozety se objednávají samostatně
- konstrukční systém s vratnou pružinou u kliky
- montáž sešroubování pouzdry proti sobě
- další fixace pomocí 2 vrtů
- rukojeti vyrobeny z masivní mosazi
- rozety vyrobeny z magnetické nerez oceli
- zajišťovací gel proti uvolnění šroubů
- vrtání PROFÍ šablonou M&T vrtákem Ø 6,4 mm
- montáž pro tloušťky dveří 38 – 126 mm
- v balení standardně montážní materiál pro tl. dveří 38 - 45 mm
- záruka 5 let, titany 15 let, rukojeti z masivní mosazi - doživotní záruka

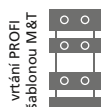

Ochranná známka – registrovaná značka **ROCKSOR®**

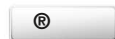

Chráněné průmyslové vzory klik **ROCKSOR**



let **5 garance**

let **15 garance**



Ms-L mosaz leštěná  
(celá rukojeť vyleštěná)

**Klika Rocksor**  
magnetická rozeta Ø54x5 mm

2040,- Kč  
85,- EUR

materiál: masivní mosaz  
povrch: Ms-K mosaz natur

**KČ** **EUR**

2040,- 85,-



3440,- 144,-



2650,- 111,-



2650,- 111,-



TiN-K titan černý mat



Ms-A mosaz antik  
(obroušené, ohlazené výstupky na rukojeti pro vzhled „používané kliky“)



Ms-A mosaz antik  
(obroušené, ohlazené výstupky na rukojeti pro vzhled „používané kliky“)

**Klika Rocksor U**  
magnetická rozeta Ø54x5 mm

2260,- Kč  
95,- EUR

materiál: masivní mosaz  
povrch: Ms-K mosaz natur

**KČ** **EUR**

2260,- 95,-



2980,- 125,-



2980,- 125,-



Ms-A mosaz antik

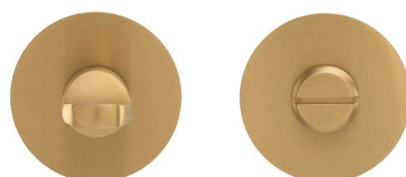

**Spodní rozety**

1000,- Kč  
42,- EUR

materiál: magnetická nerez ocel  
povrch: TiN-A titan mosaz mat

**KČ** **EUR**

1000,- 42,-



1000,- 42,-



1460,- 61,-



1140,- 48,-





		Ms-K		Ms-A		Ms-L		TiN-C		TiN-K		K-industrial	
		cena	EAN	cena	EAN	cena	EAN	cena	EAN	cena	EAN	cena	EAN
		pár		pár		pár		pár		pár		pár	
klika / klika	Kč €	2040,- 85,-	082180	2260,- 95,-	082098	2260,- 95,-	087314	3200,- 134,-	094619	3200,- 134,-	094664	3200,- 134,-	137774
madlo / madlo	Kč €	3440,- 144,-	107425	3660,- 153,-	107432	3660,- 153,-	107449	4730,- 198,-	107456	4730,- 198,-	107463	4730,- 198,-	137903
madlo / klika L	Kč €	2650,- 111,-	082210	2860,- 120,-	082043	2860,- 120,-	087345	3920,- 164,-	094640	3920,- 164,-	094695	3920,- 164,-	137781
madlo / klika R	Kč €	2650,- 111,-	082227	2860,- 120,-	082050	2860,- 120,-	087352	3920,- 164,-	094657	3920,- 164,-	094701	3920,- 164,-	137798

U povrchů Ms-A, Ms-L, Ms-K je vždy rozeta pod klikou, spodní zámkové rozety, WC mechanismus v matném „zlatém provedení“ TiN-A.



**Ms-K** mosaz natur  
(celá rukojet v naturální mosazi  
z kování, pouze zabroušené ostré hrany)



**TiN-C** titan chrom mat



		Ms-K		Ms-A		Ms-L		TiN-C		TiN-K		K-industrial	
		cena	EAN	cena	EAN	cena	EAN	cena	EAN	cena	EAN	cena	EAN
		pár		pár		pár		pár		pár		pár	
klika / klika	Kč €	2260,- 95,-	082265	2440,- 102,-	082104	2440,- 102,-	087406	3450,- 144,-	094794	3450,- 144,-	094848	3450,- 144,-	137804
madlo / klika L	Kč €	2980,- 125,-	082296	3170,- 133,-	082135	3170,- 133,-	087437	4180,- 175,-	094824	4180,- 175,-	094879	4180,- 175,-	137811
madlo / klika R	Kč €	2980,- 125,-	082302	3170,- 133,-	082142	3170,- 133,-	087444	4180,- 175,-	094831	4180,- 175,-	094886	4180,- 175,-	137828

U povrchů Ms-A, Ms-L, Ms-K je vždy rozeta pod klikou, spodní zámkové rozety, WC mechanismus v matném „zlatém provedení“ TiN-A.

		Magnetická rozeta							
		TiN-A		TiN-C		TiN-K		K-industrial	
		cena / pár	EAN	cena / pár	EAN	cena / pár	EAN	cena / pár	EAN
dozické	Kč €	1000,- 42,-	095661	1260,- 53,-	095678	1000,- 42,-	091601	1000,- 42,-	140255
cylindrické	Kč €	1000,- 42,-	095722	1260,- 53,-	095739	1000,- 42,-	091618	1000,- 42,-	140262
WC	Kč €	1460,- 61,-	095784	1860,- 78,-	095791	1460,- 61,-	091625	1460,- 61,-	140279
plná/zaslepovací	Kč €	1140,- 48,-	104899	1400,- 59,-	104905	1140,- 48,-	104875	1140,- 48,-	140286

Spodní rozety v matném „zlatém provedení“ TiN-A se dodávají ke klikám v povrchu Ms-A, Ms-L, Ms-K.



**Ms-A** mosaz antik  
(obroušené, ohlazené výstupky  
na rukojeti pro vzhled „používané kliky“)

**Klika na sklo**

1640,- Kč  
69,- EUR

**Kč** materiál: masivní mosaz  
povrch: Ms-K mosaz natur **EUR**

1640,- — — 69,-

1700,- — — 71,-



**Ms-A** mosaz antik

**Zámek na sklo Entero**

6580,- Kč  
275,- EUR

**Kč** materiál: masivní mosaz  
povrch: Ms-K mosaz natur **EUR**

6580,-  275,-

6660,-  278,-

7590,-  317,-

7730,-  323,-



**Ms-A** mosaz antik

**Pant Entero**

5760,- Kč  
240,- EUR

**Kč** materiál: masivní mosaz  
povrch: Ms-K mosaz natur **EUR**

5760,-  240,-



	<b>Ms-K</b>		<b>Ms-A</b>		<b>Ms-L</b>		<b>TiN-C</b>		<b>TiN-K</b>		<b>K-industrial</b>		
	cena	EAN	cena	EAN	cena	EAN	cena	EAN	cena	EAN	cena	EAN	
	pár		pár		pár		pár		pár		pár		
Rocksor	Kč €	1640,- 69,-	085556	1720,- 72,-	084573	1720,- 72,-	087499	2120,- 89,-	094978	2120,- 89,-	094992	2120,- 89,-	137835
Rocksor U	Kč €	1700,- 71,-	085570	1760,- 74,-	085563	1760,- 74,-	087505	2170,- 91,-	094985	2170,- 91,-	095005	2170,- 91,-	137842



	<b>Ms-K</b>		<b>Ms-A</b>		<b>Ms-L</b>		<b>TiN-C</b>		<b>TiN-K</b>		<b>K-industrial</b>		
	cena	EAN	cena	EAN	cena	EAN	cena	EAN	cena	EAN	cena	EAN	
	pár		pár		pár		pár		pár		pár		
standard	Kč €	6580,- 275,-	095111	7350,- 307,-	084528	7350,- 307,-	087512	8360,- 349,-	87835	8710,- 363,-	87798	8710,- 363,-	137859
cyklindrický	Kč €	6660,- 278,-	095128	7450,- 311,-	084535	7450,- 311,-	087529	8450,- 353,-	87842	8770,- 366,-	87804	8770,- 366,-	137866
WC	Kč €	7590,- 317,-	095135	8440,- 352,-	084542	8440,- 352,-	087536	9450,- 394,-	87859	9770,- 408,-	87811	9770,- 408,-	137873
protikus	Kč €	7730,- 323,-	095142	8610,- 359,-	084559	8610,- 359,-	087543	9720,- 405,-	87866	10040,- 419,-	87828	10040,- 419,-	137880

Uvedené ceny za zámky bez klik. Kliky/rukojeti se objednávají zvlášť a jsou uvedeny v tabulce výše.



	<b>Ms-K</b>		<b>Ms-A</b>		<b>Ms-L</b>		<b>TiN-C</b>		<b>TiN-K</b>		<b>K-industrial</b>		
	cena	EAN	cena	EAN	cena	EAN	cena	EAN	cena	EAN	cena	EAN	
	pár		pár		pár		pár		pár		pár		
	Kč €	5760,- 240,-	095241	6020,- 251,-	095234	5660,- 236,-	095258	6670,- 278,-	88207	7000,- 292,-	88191	7000,- 292,-	137897

Součástí pantů a v ceně sady pantů je střední díl pantu a vložka závěsu.



**Ms-K** mosaz natur  
(celá rukojeť v naturálnej mosazi  
z kovárny, pouze zabroušené ostré hrany)

**Klika Rocksor**  
pro Al profily

2860,- Kč  
120,- EUR

Kč	materiál: masivní mosaz povrch: Ms-K mosaz natur	EUR
2860,-		120,-
3610,-		151,-
3610,-		151,-
880,-		37,-



**Ms-A** mosaz antik  
(obroušené, ohlazené výstupky  
na rukojeti pro vzhled „používané kliky“)

**Klika Rocksor U**  
pro Al profily

3030,- Kč  
127,- EUR

Kč	materiál: masivní mosaz povrch: Ms-K mosaz natur	EUR
3030,-		127,-
3770,-		158,-
3770,-		158,-
880,-		37,-



**Ms-A** mosaz antik



**Ms-A** mosaz antik



**Ms-K** mosaz natur  
(celá rukojeť v naturálnej mosazi  
z kovárny, pouze zabroušené ostré hrany)

**Okenní klika**

1380,- Kč  
58,- EUR

Kč	materiál: masivní mosaz povrch: Ms-K mosaz natur	EUR
1380,-		58,-
1520,-		64,-



		Ms-K		Ms-A		Ms-L		TiN-C		TiN-K		K-industrial	
		cena	EAN	cena	EAN	cena	EAN	cena	EAN	cena	EAN	cena	EAN
		pár		pár		pár		pár		pár		pár	
klika / klika	Kč €	2860,- 120,-	082234	3070,- 128,-	082067	3070,- 128,-	087369	4140,- 173,-	094718	4140,- 173,-	094756	4140,- 173,-	137910
madlo / klika L	Kč €	3610,- 151,-	082241	3820,- 160,-	082074	3820,- 160,-	087376	4880,- 204,-	094725	4880,- 204,-	094763	4880,- 204,-	137927
madlo / klika R	Kč €	3610,- 151,-	082258	3820,- 160,-	082081	3820,- 160,-	087383	4880,- 204,-	094732	4880,- 204,-	094770	4880,- 204,-	137934
rozeta cylindrická 33x47 mm	Kč €	880,- 37,-	082708	930,- 39,-	082692	930,- 39,-	087390	1250,- 53,-	001983	1250,- 53,-	002676	1250,- 53,-	137941



		Ms-K		Ms-A		Ms-L		TiN-C		TiN-K		K-industrial	
		cena	EAN	cena	EAN	cena	EAN	cena	EAN	cena	EAN	cena	EAN
		pár		pár		pár		pár		pár		pár	
klika / klika	Kč €	3030,- 127,-	082319	3230,- 135,-	082159	3230,- 135,-	087451	4310,- 180,-	094893	4310,- 180,-	094930	4310,- 180,-	137958
madlo / klika L	Kč €	3770,- 158,-	082326	3970,- 166,-	082166	3970,- 166,-	087468	5040,- 210,-	094909	5040,- 210,-	094947	5040,- 210,-	137965
madlo / klika R	Kč €	3770,- 158,-	082333	3970,- 166,-	082173	3970,- 166,-	087475	5040,- 210,-	094916	5040,- 210,-	094954	5040,- 210,-	137972
rozeta cylindrická 33x47 mm	Kč €	880,- 37,-	082708	930,- 39,-	082692	930,- 39,-	087390	1250,- 53,-	001983	1250,- 53,-	002676	1250,- 53,-	137941



		Ms-K		Ms-A		Ms-L		TiN-C		TiN-K		K-industrial	
		cena	EAN	cena	EAN	cena	EAN	cena	EAN	cena	EAN	cena	EAN
		pár		pár		pár		pár		pár		pár	
Rocksor	Kč €	1380,- 58,-	095029	1480,- 62,-	095012	1480,- 62,-	095036	2010,- 84,-	095043	2010,- 84,-	095050	2010,- 84,-	137989
Rocksor U	Kč €	1520,- 64,-	095074	1630,- 68,-	095067	1630,- 68,-	095081	2160,- 90,-	095098	2160,- 90,-	095104		

Polohovací mechanismus s plochou oválnou rozetou je 3-polohový kovový a je součástí příslušenství okenní kličky. Lze zapustit do rámu okna. Oválná rozeta pod rukojetí je u povrchu Ms-A, Ms-K, Ms-L v matném „zlatém provedení“ TiN-A.

## klika ROCKSOR

design: Stanislav Fiala  
materiál: masivní mosaz  
mechanika: magnetická rozeta s vratnou pružinou



vrtání otvorů  
pro magnetické rozety

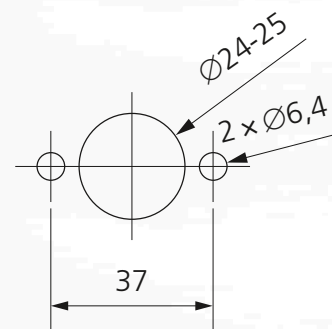







vrtání otvorů  
pro magnetické rozety

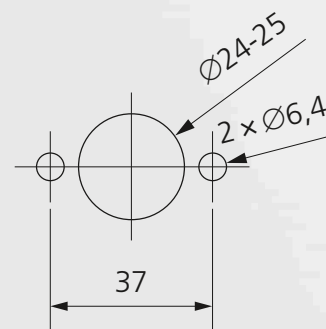

Celý projekt - jeden design

Dveřní kliky



Kliky a zámky na skleněné dveře



Kliky pro hliníkové a ocelové dveře



Panty na skleněné dveře



Bezpečnostní rozety



Okenní kliky 3-polohové



Madla dlouhá



## Dveřní kliky DESIGN 2018 Industry Squelette

Design: Roman Ulich

Materiál: nerezová ocel

Povrchy: NRz, TiN-K, TiN-B, TiN-A, TiN-C, K-industrial  
více info na [www.kliky-mt.cz/manufaktura/barvy-povrchy](http://www.kliky-mt.cz/manufaktura/barvy-povrchy)

Konstrukce, mechanika: magnetické rozety, mechanika M2018

### INDUSTRY SQUELETTE **TiN-K** titan černý mat



- Klika/klika + magnetické rozety
- Madlo/klika R + magnetické rozety
- Madlo/klika L + magnetické rozety
- Rozety dozické
- Rozety cylindrické
- Rozety WC
- Rozety zaslepovací



dozické cylindrické zaslepovací WC ex WC in

magnetické rozety Ø 54 mm, tl. 5 mm

### INDUSTRY SQUELETTE **NRz** nerez - broušeno

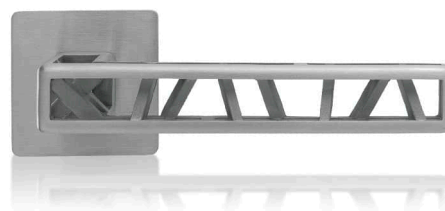

- Klika/klika + magnetické rozety
- Madlo/klika R + magnetické rozety
- Madlo/klika L + magnetické rozety
- Rozety dozické
- Rozety cylindrické
- Rozety WC
- Rozety zaslepovací



dozické cylindrické zaslepovací WC ex WC in

magnetické rozety 54x54 mm, tl. 5 mm

#### konstrukční varianty, materiálové provedení

- designová sada standardně bez spodních rozet
- spodní rozety se objednávají samostatně
- konstrukční systém s vratnou pružinou u kliky
- montáž sešroubování pouzdry proti sobě
- další fixace pomocí 2 vrutů
- rukojeti vyrobeny z nerezové oceli
- rozety vyrobeny z magnetické nerez oceli
- zajišťovací gel proti uvolnění šroubů
- vrtání PROFI šablonou M&T vrtákem Ø 6,4 mm
- montáž pro tloušťky dveří 38 – 126 mm
- v balení standardně montážní materiál pro tl. dveří 38 - 45 mm
- záruka 5 let, titany 15 let

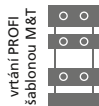

let **5 garance** let **15 garance**

Ochranná známka – registrovaná značka

**INDUSTRY®**



Chráněné průmyslové vzory klik

**INDUSTRY**





TiN-K titan černý mat

**Industry Squelette**

2600,- Kč  
109,- EUR

materiál: nerezová ocel  
Kč povrch: NRz nerez - broušeno EUR

2600,-		109,-
4070,-		170,-
3280,-		137,-
3280,-		137,-



NRz nerez - broušeno

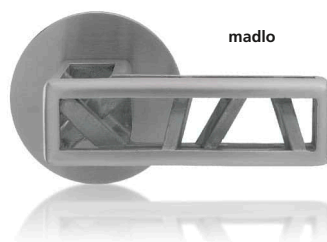

madlo

NRz nerez - broušeno

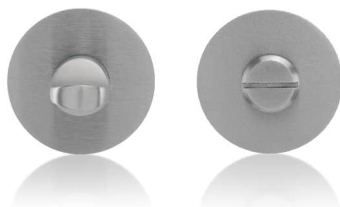

**Spodní rozety**

540,- Kč  
23,- EUR

materiál: magnetická nerez ocel  
Kč povrch: NRz nerez - broušeno EUR

540,-		23,-
540,-		23,-
1000,-		42,-
670,-		28,-



TiN-B titan braun mat

**Industry Squelette**

2910,- Kč  
122,- EUR

materiál: nerezová ocel  
Kč povrch: NRz nerez - broušeno EUR

2910,-		122,-
4360,-		182,-
3580,-		150,-
3580,-		150,-



TiN-K titan černý mat



**Spodní rozety**

650,- Kč  
28,- EUR

materiál: magnetická nerez ocel  
Kč povrch: NRz nerez - broušeno EUR

650,-		28,-
650,-		28,-
1190,-		50,-
790,-		33,-

Protipožární provedení (kovové podrozety + nerezové spojovací prvky, čtyřhran) ... příplatek 490,- Kč ... EAN 082289.  
Provedení panikové pro zámky s děleným čtyřhranem nelze dodat na magnetických rozetách. Lze dodat na rozetách pro Al profily. Dělený čtyřhran se objednává zvlášť a je třeba specifikovat přesnou délku čtyřhranu, str. 377.

		Magnetická rozeta											
		NRz		TiN-K		TiN-B		TiN-A		TiN-C		K-industrial	
		cena / pár	EAN	cena / pár	EAN	cena / pár	EAN	cena / pár	EAN	cena / pár	EAN	cena / pár	EAN
klika / klika	Kč €	2600,- 109,-	103472	3680,- 154,-	103533	4200,- 175,-	103564	4200,- 175,-	103595	4200,- 175,-	103625	3680,- 154,-	103502
madlo / madlo	Kč €	4070,- 170,-	107470	5150,- 215,-	107494	5810,- 243,-	107500	5810,- 243,-	107517	5810,- 243,-	107524	5150,- 215,-	107487
madlo / klika R	Kč €	3280,- 137,-	103489	4340,- 181,-	103540	5000,- 209,-	103571	5000,- 209,-	103601	5000,- 209,-	103632	4340,- 181,-	103519
madlo / klika L	Kč €	3280,- 137,-	103496	4340,- 181,-	103557	5000,- 209,-	103588	5000,- 209,-	103618	5000,- 209,-	103649	4340,- 181,-	103526

Spojovací čtyřhran 8 x 8 mm z nerez oceli se dodává ve stejném povrchu jako kliky a je součástí balení klik. Délka 95 mm pro dveře tl. 38 - 45 mm. Čtyřhrany pro tl. dveří od 46 mm nejsou součástí balení a objednávají se zvlášť, viz tabulka čtyřhranů na další stránce.



TiN-C titan chrom mat

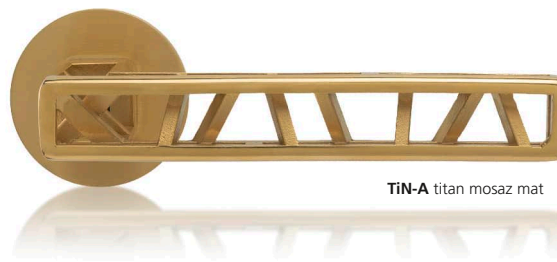

TiN-A titan mosaz mat

		Magnetická rozeta											
		NRz		TiN-K		TiN-B		TiN-A		TiN-C		K-industrial	
		cena / pár	EAN	cena / pár	EAN	cena / pár	EAN	cena / pár	EAN	cena / pár	EAN	cena / pár	EAN
dozické	Kč €	540,- 23,-	091571	1000,- 42,-	091601	1260,- 53,-	095685	1000,- 42,-	095661	1260,- 53,-	095678	1000,- 42,-	140255
cyklindrické	Kč €	540,- 23,-	091588	1000,- 42,-	091618	1260,- 53,-	095746	1000,- 42,-	095722	1260,- 53,-	095739	1000,- 42,-	140262
WC	Kč €	1000,- 42,-	091595	1460,- 61,-	091625	1860,- 78,-	095807	1460,- 61,-	095784	1860,- 78,-	095791	1460,- 61,-	140279
plná/zaslepovací	Kč €	670,- 28,-	104851	1140,- 48,-	104875	1400,- 59,-	104882	1140,- 48,-	104899	1400,- 59,-	104905	1140,- 48,-	140286

		Magnetická rozeta											
		NRz		TiN-K		TiN-B		TiN-A		TiN-C		K-industrial	
		cena / pár	EAN	cena / pár	EAN	cena / pár	EAN	cena / pár	EAN	cena / pár	EAN	cena / pár	EAN
klika / klika	Kč €	2910,- 122,-	103656	3960,- 165,-	103717	4500,- 188,-	103748	4500,- 188,-	103779	4500,- 188,-	103809	3960,- 165,-	103687
madlo / madlo	Kč €	4360,- 182,-	107531	5430,- 227,-	107555	6100,- 255,-	107562	6100,- 255,-	107579	6100,- 255,-	107586	5430,- 227,-	107548
madlo / klika R	Kč €	3580,- 150,-	103663	4630,- 193,-	103724	5290,- 221,-	103755	5290,- 221,-	103786	5290,- 221,-	103816	4630,- 193,-	103694
madlo / klika L	Kč €	3580,- 150,-	103670	4630,- 193,-	103731	5290,- 221,-	103762	5290,- 221,-	103793	5290,- 221,-	103823	4630,- 193,-	103700

Spojovací čtyřhran 8 x 8 mm z nerez oceli se dodává ve stejném povrchu jako kliky a je součástí balení klik. Délka 95 mm pro dveře tl. 38 - 45 mm. Čtyřhrany pro tl. dveří od 46 mm nejsou součástí balení a objednávají se zvlášť, viz tabulka čtyřhranů na další stránce.

		Magnetická rozeta											
		NRz		TiN-K		TiN-B		TiN-A		TiN-C		K-industrial	
		cena / pár	EAN	cena / pár	EAN	cena / pár	EAN	cena / pár	EAN	cena / pár	EAN	cena / pár	EAN
dozické	Kč €	650,- 28,-	093551	1110,- 47,-	093582	1390,- 58,-	095869	1110,- 47,-	095845	1390,- 58,-	095852	1110,- 47,-	140293
cyklindrické	Kč €	650,- 28,-	093568	1110,- 47,-	093599	1390,- 58,-	095920	1110,- 47,-	095906	1390,- 58,-	095913	1110,- 47,-	140309
WC	Kč €	1190,- 50,-	093575	1650,- 69,-	093605	2050,- 86,-	095982	1650,- 69,-	095968	2050,- 86,-	095975	1650,- 69,-	140316
plná/zaslepovací	Kč €	790,- 33,-	105032	1250,- 53,-	105056	1520,- 64,-	105063	1250,- 53,-	105070	1520,- 64,-	105087	1250,- 53,-	140323



TiN-A titan mosaz mat



TiN-K titan černý mat

### Čtyřhran

94,- Kč  
4,- EUR

materiál: nerezová ocel  
povrch: NRz nerez - broušeno

Kč		EUR
95,-		4,-
130,-		5,5
150,-		6,3
160,-		6,7
180,-		7,5



TiN-K titan černý mat

### Klika na sklo

2800,- Kč  
117,- EUR

materiál: nerezová ocel  
povrch: TiN-K titan černý mat

Kč		EUR
2800,-		117,-



TiN-K titan černý mat

### Zámek na sklo Entero

8710,- Kč  
363,- EUR

materiál: masivní mosaz  
povrch: TiN-K titan černý mat

Kč		EUR
8710,-		363,-
8770,-		366,-
9770,-		408,-
10040,-		419,-



TiN-K titan černý mat

### Pant Entero

7000,- Kč  
292,- EUR

materiál: masivní mosaz  
povrch: TiN-K titan černý mat

Kč		EUR
7000,-		292,-

		NRz		TiN-K		TiN-B		TiN-A		TiN-C	
		cena	EAN	cena	EAN	cena	EAN	cena	EAN	cena	EAN
délka čtyřhranu 105 mm pro tl. dveří 46 - 55 mm	Kč €	95,- 4,-	095876	310,- 13,-	093711	310,- 13,-	103908	310,- 13,-	104011	310,- 13,-	104608
délka čtyřhranu 115 mm pro tl. dveří 56 - 65 mm	Kč €	130,- 5,5	093629	340,- 15,-	093728	340,- 15,-	103939	340,- 15,-	104028	340,- 15,-	104141
délka čtyřhranu 125 mm pro tl. dveří 66 - 75 mm	Kč €	150,- 6,3	093636	350,- 15,-	103854	350,- 15,-	103946	350,- 15,-	104059	350,- 15,-	104189
délka čtyřhranu 135 mm pro tl. dveří 76 - 85 mm	Kč €	160,- 6,7	093643	370,- 16,-	103861	370,- 16,-	103977	370,- 16,-	104066	370,- 16,-	104073
spec. délka čtyřhranu pro tl. dveří 86 mm a více	Kč €	180,- 7,5	093650	400,- 17,-	103892	400,- 17,-	103984	400,- 17,-	104523	400,- 17,-	104080

Standardní čtyřhran délky 95 mm v barvě kliky pro tl. dveří 38 - 45 mm je součástí balení. Pro větší tloušťky dveří se čtyřhrany objednávají samostatně podle tabulky, tzn. že pro dveře od tl. 46 mm není čtyřhran součástí balení a je zapotřebí ho objednat zvlášť podle tabulky výše.

		TiN-K		TiN-B		TiN-A		TiN-C		NRz *)		K-industrial	
		cena	EAN	cena	EAN	cena	EAN	cena	EAN	cena	EAN	cena	EAN
Industry Squelette	Kč €	2800,- 117,-	104097	3070,- 128,-	104103	3070,- 128,-	104110	3070,- 128,-	104127	2010,- 84,-	101430	2800,- 117,-	142648

\*) Klika na sklo v povrchu NRz - nerez broušeno se kombinuje se zámkem na sklo Mini NRz a pantem Entero NRz, viz sekce v katalogu Nerezové zámky a panty na sklo.

		TiN-K		TiN-B		TiN-A		TiN-C		K-industrial	
		cena	EAN	cena	EAN	cena	EAN	cena	EAN	cena	EAN
standard	Kč €	8710,- 363,-	87798	9030,- 377,-	90774	9030,- 377,-	104295	8360,- 349,-	87835	8710,- 363,-	137859
cylindrický	Kč €	8770,- 366,-	87804	9100,- 380,-	90781	9100,- 380,-	104301	8450,- 353,-	87842	8770,- 366,-	137866
WC	Kč €	9770,- 408,-	87811	10110,- 422,-	90798	10110,- 422,-	104318	9450,- 394,-	87859	9770,- 408,-	137873
protikus	Kč €	10040,- 419,-	87828	10380,- 433,-	90804	10380,- 433,-	104325	9720,- 405,-	87866	10040,- 419,-	137880

Uvedené ceny za zámky bez klik. Kliky/rukojeti se objednávají zvlášť a jsou uvedeny v tabulce výše.

		TiN-K		TiN-B		TiN-C		TiN-A		K-industrial	
		cena	EAN	cena	EAN	cena	EAN	cena	EAN	cena	EAN
	Kč €	7000,- 292,-	88191	7330,- 306,-	88214	6670,- 278,-	88207	7330,- 306,-	104332	7000,- 292,-	137897

Součástí pantů a v ceně sady pantů je střední díl pantu a vložka závěsu.



**Okenní klika  
Industry Squelette**

1740,- Kč  
73,- EUR

TiN-K titan černý mat

materiál: nerezová ocel  
Kč povrch: NRz nerez - broušeno EUR

1740,-		73,-
1880,-		79,-



**Klika Industry Squelette  
pro Al profily**

3430,- Kč  
143,- EUR

TiN-K titan černý mat

materiál: nerezová ocel  
Kč povrch: NRz nerez - broušeno EUR

3430,-		143,-
4100,-		171,-
4100,-		171,-
880,-		37,-



**Madlo dlouhé Industry Squelette**

10390,- Kč  
433,- EUR

TiN-K titan černý mat

Madlo je celé ručně vyráběné, konstrukčně komplikované, ale velmi pevné. Nikdy nebude tvarově dokonalé, každý kus je originál.

materiál: nerezová ocel  
Kč povrch: NRz nerez - broušeno EUR

10390,-		433,-
5200,-		217,-



		NRz		TiN-K		TiN-B		TiN-A		TiN-C		K-industrial	
		cena	EAN	cena	EAN	cena	EAN	cena	EAN	cena	EAN	cena	EAN
		ks		ks		ks		ks		ks		ks	
oválná rozeta	Kč €	1740,- 73,-	104370	2280,- 95,-	104417	2550,- 107,-	104431	2550,- 107,-	104455	2550,- 107,-	104479	2280,- 95,-	104394
obdélníková rozeta	Kč €	1880,- 79,-	104387	2400,- 100,-	104424	2670,- 112,-	104448	2670,- 112,-	104462	2670,- 112,-	104486	2400,- 100,-	104400

Polohovací mechanismus s plochým štítkem je 3-polohový kovový a je součástí příslušenství okenní kliky. lze ho zapustit včetně štítku do rámu okna. Viditelný čtyřhran ovládací mechaniky nelze pokovit do barvy kliky. Ovládací mechanika se čtyřhranem je standardně dodávána ve stříbrném pozinku.

		NRz		TiN-K		TiN-B		TiN-A		TiN-C		K-industrial	
		cena	EAN	cena	EAN	cena	EAN	cena	EAN	cena	EAN	cena	EAN
		pár		pár		pár		pár		pár		pár	
klika / klika	Kč €	3430,- 143,-	104493	4630,- 193,-	104578	5020,- 210,-	104615	5020,- 210,-	104653	5020,- 210,-	104691	4630,- 193,-	104530
madlo / klika L	Kč €	4100,- 171,-	104509	5170,- 216,-	104585	5830,- 243,-	104622	5830,- 243,-	104660	5830,- 243,-	104707	5170,- 216,-	104547
madlo / klika R	Kč €	4100,- 171,-	104516	5170,- 216,-	104592	5830,- 243,-	104639	5830,- 243,-	104677	5830,- 243,-	104714	5170,- 216,-	104554
rozeta cylindrická 33x49 mm	Kč €	880,- 37,-	024098	1180,- 50,-	024111	1440,- 60,-	104646	1440,- 60,-	104684	1440,- 60,-	104721	1180,- 50,-	034059

Dodáváme s rozetou 33x49 mm - tl. = 12 mm.

		NRz		TiN-K		TiN-B		TiN-A		TiN-C		K-industrial	
		cena	EAN	cena	EAN	cena	EAN	cena	EAN	cena	EAN	cena	EAN
rozteč 250 mm oboustranné	Kč €	pár 10390,- 433,-	103830	pár 13040,- 544,-	103915	pár 14370,- 599,-	103953	pár 14370,- 599,-	103991	pár 14370,- 599,-	104035	pár 13040,- 544,-	103878
rozteč 250 mm jednostranné	Kč €	ks 5200,- 217,-	103847	ks 6530,- 273,-	103922	ks 7200,- 300,-	103960	ks 7200,- 300,-	104004	ks 7200,- 300,-	104042	ks 6530,- 273,-	103885

Montážní materiál pro madla	cena	EAN
jednostranné do slepé díry - plast	Kč € sada	390,- 17,- 030204
jednostranné do slepé díry - hliník	Kč € sada	390,- 17,- 030211
jednostranné do slepé díry - dřevo	Kč € sada	390,- 17,- 030228

Montážní materiál pro madla	cena	EAN
jednostranné s prošroubováním a záslepkou	Kč € sada	390,- 17,- 003024
jednostranné na sklo s prošroubováním a záslepkou	Kč € sada	510,- 22,- 003031
oboustranné	Kč € sada	390,- 17,- 003048
oboustranné na sklo	Kč € sada	510,- 22,- 003055

Ceny model jsou uvedeny bez montážního materiálu. Montážní materiál je nutno specifikovat podle materiálu dveří.



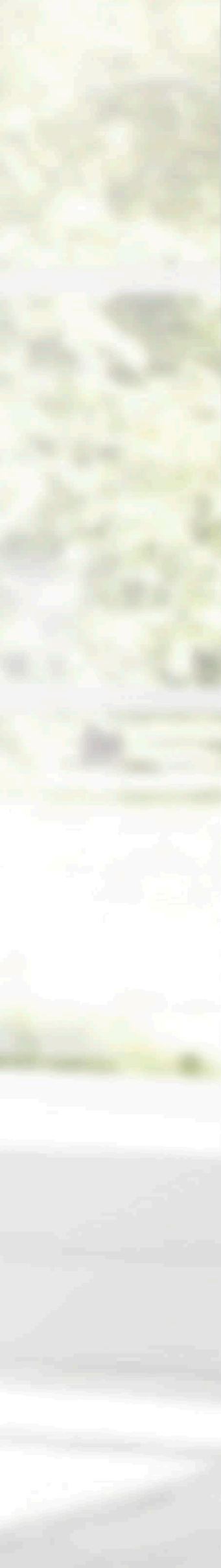





## klika INDUSTRY SQUELETTE

design: Roman Ulich  
materiál: nerezová ocel  
mechanika: magnetická rozeta s vratnou pružinou



## UP & DOWN

1 klika - 2 tvary

výjimečný designérský počín, kdy lze pouhou změnou pozice na dveřích úplně zaměnit osobitý výraz kliky, její vnímání i ovládání



design: Herrmann & Coufal

## Dveřní kliky DESIGN 2021 Up & Down

Design: Herrmann & Coufal

Materiál: masivní mosaz

Povrchy: Sni-broušeno, Cr, TiN-A, TiN-C, TiN-B, TiN-K  
více info na [www.kliky-mt.cz/manufaktura/barvy-povrchy](http://www.kliky-mt.cz/manufaktura/barvy-povrchy)

Konstrukce, mechanika: magnetické rozety, mechanika M2018

### UP TiN-K titan černý mat



- Klika/klika + magnetické rozety
- Koule/klika R + magnetické rozety
- Koule/klika L + magnetické rozety

### DOWN TiN-A titan mosaz mat



- Klika/klika + magnetické rozety
- Koule/klika R + magnetické rozety
- Koule/klika L + magnetické rozety

- Rozety dozické
- Rozety cylindrické
- Rozety WC
- Rozety zaslepovací



dozické



cylindrické



zaslepovací



WC ex



WC in



koule Maty

magnetické rozety Ø 54 mm, tl. 5 mm

konstrukční varianty, materiálové provedení

- set kování s 1 vratnou pružinou
- standardně bez spodních rozet
- spodní rozety se objednávají samostatně
- sešroubování pouzdry proti sobě
- příprava do dveří: vrtání otvoru průměr 24 – 25mm
- zajišťovací gel proti uvolnění červíků
- vrtání PROFI šablonou M&T vrtákem Ø 6,4 mm
- montáž pro tloušťky dveří 38 – 70 mm
- v balení standardně montážní materiál pro tl. dveří 38 - 42 mm
- záruka 3 roky, titany 15 let

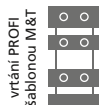

Chráněné průmyslové vzory klik

design

UP  
DOWN

roky **3 garance** let **15 garance**



SNi-broušeno matný nikl broušeno

4200,- Kč  
175,- EUR

**Up**

materiál: masivní mosaz  
Kč povrch: SNi matný nikl broušeno EUR

4200,- 175,-

4880,- 204,-

4880,- 204,-



TiN-A titan mosaz mat



TiN-K titan černý mat

**Down**

materiál: masivní mosaz  
Kč povrch: SNi matný nikl broušeno EUR

4200,- 175,-

4880,- 204,-

4880,- 204,-



Cr lesklý chrom

4200,- Kč  
175,- EUR



**Spodní rozety**

materiál: magnetická nerez ocel  
Kč povrch: SNi matný nikl broušeno EUR

670,- 28,-

670,- 28,-

1580,- 66,-

800,- 34,-



670,- Kč  
28,- EUR



V prodeji od 01. 03. 2022

		Sni - broušeno		TiN-C		TiN-K		TiN-B		TiN-A	
		cena	EAN	cena	EAN	cena	EAN	cena	EAN	cena	EAN
		pár		pár		pár		pár		pár	
klika / klika	Kč €	4200,- 175,-	147070	5430,- 227,-	147131	5430,- 227,-	147162	5430,- 227,-	147193	5430,- 227,-	147223
koule / klika R	Kč €	4880,- 204,-	147087	6120,- 255,-	147148	6120,- 255,-	147179	6120,- 255,-	147209	6120,- 255,-	147230
koule / klika L	Kč €	4880,- 204,-	147094	6120,- 255,-	147155	6120,- 255,-	147186	6120,- 255,-	147216	6120,- 255,-	147247

Konstrukce klik vyžaduje dodání vždy přesné délky ovládacího montážního materiálu pro konkrétní tloušťku dveří viz. tabulka montážního materiálu v délkách po 4 mm. Montážní materiál pro standardní tloušťku dveří 38-42 mm je součástí dodávky a je v ceně dodávky.



TiN-B titan braun mat

Montážní materiál							
tloušťka dveří	cena	EAN	tloušťka dveří	cena	EAN		
	sada			sada			
42,1 - 44 mm	Kč €	84,- 3,5	145274	52,1 - 54 mm	Kč €	120,- 5,-	145328
44,1 - 46 mm	Kč €	84,- 3,5	145281	54,1 - 56 mm	Kč €	120,- 5,-	145335
46,1 - 48 mm	Kč €	84,- 3,5	145298	56,1 - 58 mm	Kč €	120,- 5,-	145342
48,1 - 50 mm	Kč €	84,- 3,5	145304	58,1 - 60 mm	Kč €	120,- 5,-	145359
50,1 - 52 mm	Kč €	120,- 5,-	145311	60,1 mm a více*	Kč €	140,- 5,9	145366

\* nutno určit přesnou tloušťku dveří

		Sni - broušeno		Cr		TiN-C		TiN-K		TiN-B		TiN-A	
		cena	EAN	cena	EAN	cena	EAN	cena	EAN	cena	EAN	cena	EAN
		pár		pár		pár		pár		pár		pár	
klika / klika	Kč €	4200,- 175,-	147254	4460,- 186,-	147285	5430,- 227,-	147315	5430,- 227,-	147346	5430,- 227,-	147377	5430,- 227,-	147407
koule / klika R	Kč €	4880,- 204,-	147261	5130,- 214,-	147292	6120,- 255,-	147322	6120,- 255,-	147353	6120,- 255,-	147384	6120,- 255,-	147414
koule / klika L	Kč €	4880,- 204,-	147278	5130,- 214,-	147308	6120,- 255,-	147339	6120,- 255,-	147360	6120,- 255,-	147391	6120,- 255,-	147421

Konstrukce klik vyžaduje dodání vždy přesné délky ovládacího montážního materiálu pro konkrétní tloušťku dveří viz. tabulka montážního materiálu v délkách po 4 mm. Montážní materiál pro standardní tloušťku dveří 38-42 mm je součástí dodávky a je v ceně dodávky.

		Magnetická rozeta											
		Sni - broušeno		Cr		TiN-C		TiN-K		TiN-B		TiN-A	
		cena / pár	EAN	cena / pár	EAN	cena / pár	EAN	cena / pár	EAN				
dozické	Kč €	670,- 28,-	144901	790,- 33,-	095654	1260,- 53,-	095678	1000,- 42,-	091601	1260,- 53,-	095685	1000,- 42,-	095661
cylindrické	Kč €	670,- 28,-	144918	790,- 33,-	095715	1260,- 53,-	095739	1000,- 42,-	091618	1260,- 53,-	095746	1000,- 42,-	095722
WC	Kč €	1580,- 66,-	144840	1790,- 75,-	144857	2090,- 88,-	144864	2090,- 88,-	144871	2090,- 88,-	144888	2090,- 88,-	144895
zaslepovací	Kč €	800,- 34,-	144925	920,- 39,-	101157	1400,- 59,-	104905	1140,- 48,-	104875	1400,- 59,-	104882	1140,- 48,-	104899

## Oblíbené povrchy



vrtání otvorů  
pro magnetické rozety

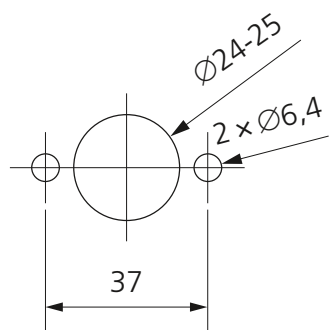

**TiN-K** titan černý mat  
**TiN-A** titan mosaz mat  
**TiN-B** titan braun mat

**UP**

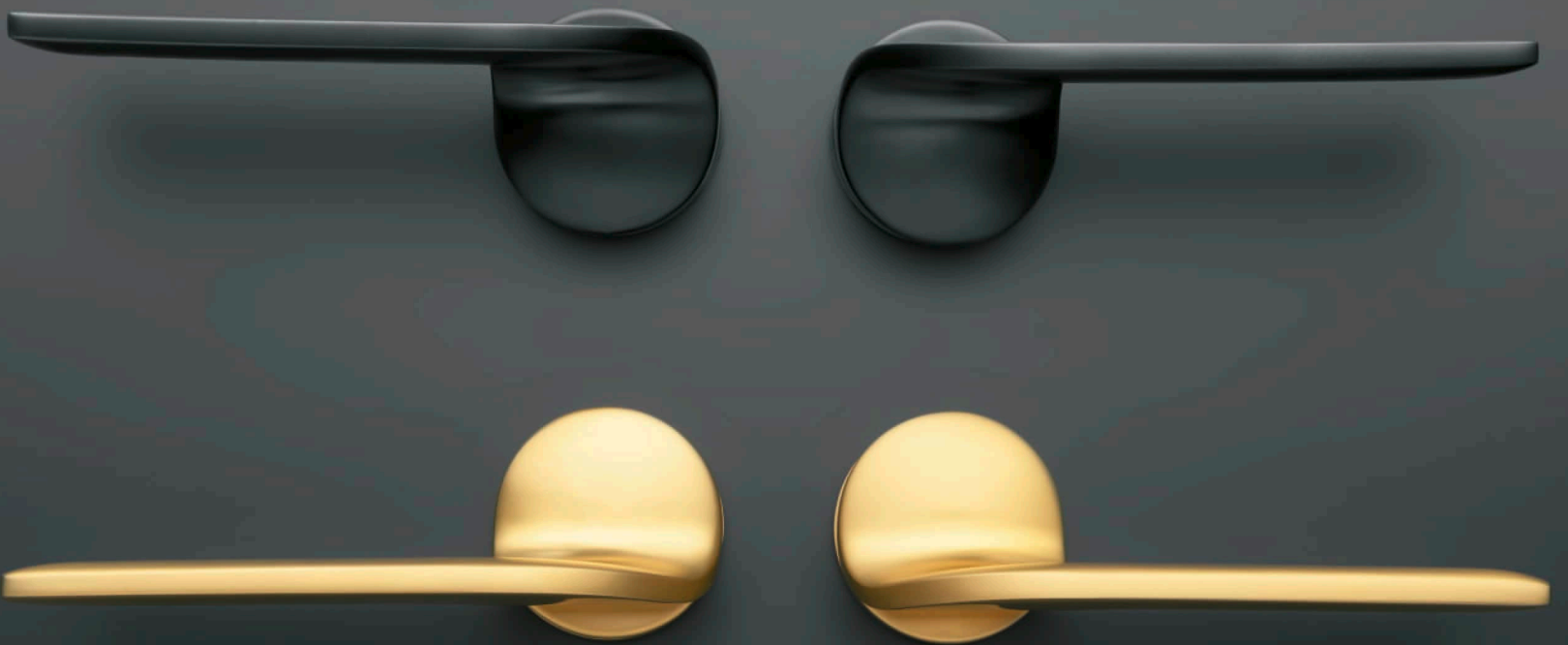

**DOWN**



Ochranná známka – registrovaná značka **ENTERO®**

Chráněné průmyslové vzory klik **MORGAN  
ENTERO**

Příbuzný sortiment

Kování pro hliníkové a ocelové dveře,  
kování na branky



Rozetové kování



Bezpečnostní štítové kování



Madla dlouhá



Bezpečnostní rozety



## Štitové kování NEREZ

Materiál: **nerezová ocel ANSI 304**

Povrchy: **NRz** nerez - broušeno, **TiN-K** titan černý mat, **K-industrial** černý mat strukturovaný

Nerezové štitové kování M&T je připraveno pro projekty a realizace s požadavkem na standardní design, ale s důrazem na dlouhodobou životnost a perfektní funkčnost. Velkou předností štitového kování M&T je možnost dodávek ve všech požadovaných rozměrech/roztečích i ve variantě plného štitu. Nadstandardem je možnost dodání kování v povrchu TiN-K titan černý mat.

**LUSY NRz** nerez ocel broušeno

**MORGAN TiN-K** titan černý mat

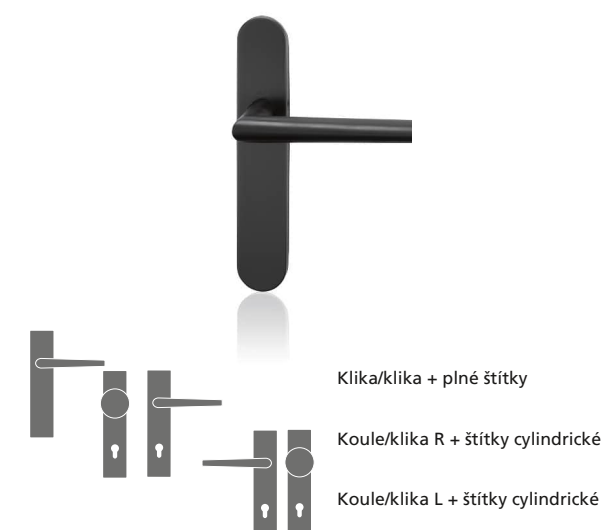
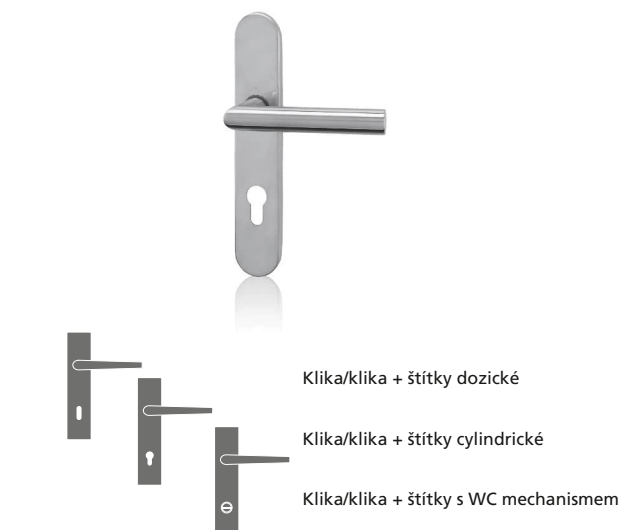

konstrukční varianty, materiálové provedení

### Objekt

- kování s vratnou pružinou
- kovový vnitřní štít
- nacvakávací krycí nerezový štít
- zajišťovací gel
- montáž na dveře do tl. 126 mm
- záruka 5 let, titan 15 let

let **5 garance**      let **15 garance**

Zatřídění kování podle normy EN 1906:2012, ČSN EN 1906 16 5776  
Prohlášení o shodě na [www.kliky-mt.cz/certifikaty](http://www.kliky-mt.cz/certifikaty)

**Objekt**      **36-0031B**

- 3** Kategorie použití .. vysoká frekvence používání veřejností nebo jinými uživateli s malou motivací o pečlivé používání a kde je vysoká pravděpodobnost nesprávného použití, např. dveře u veřejných kancelářích
- 6** Životnost .. střední frekvence používání: 100 000 cyklů
- Hmotnost dveří .. (bez klasifikace)
- 0** Požární odolnost .. (není požadována odolnost)
- 0** Ochrana .. normální použití
- 3** Odolnost proti korozi .. vysoká odolnost
- 1** Bezpečnost .. mírná odolnost proti vloupání
- B** Typ ovládání .. kování s vratnou pružinou

### Projekt tř. 4, protipožární odolnost

- kování s vratnou pružinou
- kovový vnitřní štít
- nacvakávací krycí nerezový štít
- celonerezové provedení vč. krčku
- nerezový čtyřhran
- nerezový červík
- zajišťovací gel
- montáž na dveře do tl. 126 mm
- záruka 7 let, titan 15 let

let **7 garance**      let **15 garance**

**Projekt tř. 4**      **47-D1141B**

- 4** Kategorie použití .. vysoká frekvence používání na dveřích, které jsou předmětem častého hrubého používání, např. fotbalové stadiony, kasárna, veřejné toalety, atd.
- 7** Životnost .. vysoká frekvence používání: 200 000 cyklů
- Hmotnost dveří .. (bez klasifikace)
- D1** Požární odolnost .. pro použití na kouřotěsných a požárně odolných dveřích s požadavky na speciální střed v klíče/knoflíku, zkoušených s 200000 cykly na zkušebních dveřích.
- 1** Ochrana .. použití v situacích vyžadujících ochranu
- 4** Odolnost proti korozi .. velmi vysoká odolnost
- 1** Bezpečnost .. mírná odolnost proti vloupání
- B** Typ ovládání .. kování s vratnou pružinou



NRz nerez - broušeno

**Lusy**

1320,- Kč  
 55,- EUR



**Deny**

1320,- Kč  
 55,- EUR



**Entero**

2640,- Kč  
 110,- EUR

materiál: nerezová ocel  
 povrch: NRz nerez - broušeno

**Kč** **EUR**

1320,-		55,-
1320,-		55,-
1750,-		73,-
2050,-		86,-
2050,-		86,-

1320,-		55,-
1320,-		55,-
1750,-		73,-
2050,-		86,-
2050,-		86,-
1620,-		68,-

1320,-		55,-
1320,-		55,-
1750,-		73,-
2050,-		86,-
2050,-		86,-

1320,-		55,-
1320,-		55,-
1750,-		73,-
2050,-		86,-
2050,-		86,-
1620,-		68,-

2640,-		110,-
2640,-		110,-
3170,-		133,-
3510,-		147,-
3510,-		147,-

2640,-		110,-
2640,-		110,-
3170,-		133,-
3510,-		147,-
3510,-		147,-
2930,-		123,-

	Objekt nerez			Objekt titan		Objekt		Projekt tř. 4, (i protipožární)		Projekt tř. 4, (i protipožární)	
	NRz			TiN-K		K-industrial		NRz		TiN-K	
	cena / pár	EAN		cena / pár	EAN	cena / pár	EAN	cena / pár	EAN	cena / pár	EAN
<b>72 mm</b>											
dozický	Kč €	1320,- 55,-	017892	2780,- 116,-	017946	2780,- 116,-	032444	1620,- 68,-	017991	3070,- 128,-	018042
cylinrický	Kč €	1320,- 55,-	017908	2780,- 116,-	017953	2780,- 116,-	032451	1620,- 68,-	018004	3070,- 128,-	018059
WC	Kč €	1750,- 73,-	017915	3220,- 135,-	017960	3220,- 135,-	032468	2050,- 86,-	018011	3510,- 147,-	018066
koule / klika R	Kč €	2050,- 86,-	017922	3510,- 147,-	017977	3810,- 159,-	032475	2350,- 98,-	018028	3810,- 159,-	018073
koule / klika L	Kč €	2050,- 86,-	017939	3510,- 147,-	017984	3510,- 147,-	032482	2350,- 98,-	018035	3810,- 159,-	018080
<b>90 mm</b>											
dozický	Kč €	1320,- 55,-	018899	2780,- 116,-	018943	2780,- 116,-	032499	1620,- 68,-	018998	3070,- 128,-	019049
cylinrický	Kč €	1320,- 55,-	018905	2780,- 116,-	018950	2780,- 116,-	032505	1620,- 68,-	019001	3070,- 128,-	019056
WC	Kč €	1750,- 73,-	018912	3220,- 135,-	018967	3220,- 135,-	032512	2050,- 86,-	019018	3510,- 147,-	019063
koule / klika R	Kč €	2050,- 86,-	018929	3510,- 147,-	018974	3510,- 147,-	032529	2350,- 98,-	019025	3810,- 159,-	019070
koule / klika L	Kč €	2050,- 86,-	018936	3510,- 147,-	018981	3510,- 147,-	032536	2350,- 98,-	019032	3810,- 159,-	019087
plný štítek	Kč €	1620,- 68,-	023152	3070,- 128,-	023169	3070,- 128,-	032543	1910,- 80,-	023176	3380,- 141,-	023183
<b>72 mm</b>											
dozický	Kč €	1320,- 55,-	018097	2780,- 116,-	018141	2780,- 116,-	032550	1620,- 68,-	018196	3070,- 128,-	018240
cylinrický	Kč €	1320,- 55,-	018103	2780,- 116,-	018158	2780,- 116,-	032567	1620,- 68,-	018202	3070,- 128,-	018257
WC	Kč €	1750,- 73,-	018110	3220,- 135,-	018165	3220,- 135,-	032574	2050,- 86,-	018219	3510,- 147,-	018264
koule / klika R	Kč €	2050,- 86,-	018127	3510,- 147,-	018172	3510,- 147,-	032581	2350,- 98,-	018226	3810,- 159,-	018271
koule / klika L	Kč €	2050,- 86,-	018134	3510,- 147,-	018189	3510,- 147,-	032598	2350,- 98,-	018233	3810,- 159,-	018288
<b>90 mm</b>											
dozický	Kč €	1320,- 55,-	019094	2780,- 116,-	019148	2780,- 116,-	032604	1620,- 68,-	019193	3070,- 128,-	019247
cylinrický	Kč €	1320,- 55,-	019100	2780,- 116,-	019155	2780,- 116,-	032611	1620,- 68,-	019209	3070,- 128,-	019254
WC	Kč €	1750,- 73,-	019117	3220,- 135,-	019162	3220,- 135,-	032628	2050,- 86,-	019216	3510,- 147,-	019261
koule / klika R	Kč €	2050,- 86,-	019124	3510,- 147,-	019179	3510,- 147,-	032635	2350,- 98,-	019223	3810,- 159,-	019278
koule / klika L	Kč €	2050,- 86,-	019131	3510,- 147,-	019186	3510,- 147,-	032642	2350,- 98,-	019230	3810,- 159,-	019285
plný štítek	Kč €	1620,- 68,-	023190	3070,- 128,-	023206	3070,- 128,-	032659	1910,- 80,-	023213	3380,- 141,-	023220
<b>72 mm</b>											
dozický	Kč €	2640,- 110,-	018691	4100,- 171,-	018745	4100,- 171,-	032666	2930,- 123,-	018790	4380,- 183,-	018844
cylinrický	Kč €	2640,- 110,-	018707	4100,- 171,-	018752	4100,- 171,-	032673	2930,- 123,-	018806	4380,- 183,-	018851
WC	Kč €	3170,- 133,-	018714	4630,- 193,-	018769	4630,- 193,-	032680	3450,- 144,-	018813	4930,- 206,-	018868
koule / klika R	Kč €	3510,- 147,-	018721	4980,- 208,-	018776	4980,- 208,-	032697	3810,- 159,-	018820	5270,- 220,-	018875
koule / klika L	Kč €	3510,- 147,-	018738	4980,- 208,-	018783	4980,- 208,-	032703	3810,- 159,-	018837	5270,- 220,-	018882
<b>90 mm</b>											
dozický	Kč €	2640,- 110,-	019698	4100,- 171,-	019742	4100,- 171,-	032710	2930,- 123,-	019797	4380,- 183,-	019841
cylinrický	Kč €	2640,- 110,-	019704	4100,- 171,-	019759	4100,- 171,-	032727	2930,- 123,-	019803	4380,- 183,-	019858
WC	Kč €	3170,- 133,-	019711	4630,- 193,-	019766	4630,- 193,-	032734	3450,- 144,-	019810	4930,- 206,-	019865
koule / klika R	Kč €	3510,- 147,-	019728	4980,- 208,-	019773	4980,- 208,-	032741	3810,- 159,-	019827	5270,- 220,-	019872
koule / klika L	Kč €	3510,- 147,-	019735	4980,- 208,-	019780	4980,- 208,-	032758	3810,- 159,-	019834	5270,- 220,-	019889
plný štítek	Kč €	2930,- 123,-	023237	4380,- 183,-	023244	4380,- 183,-	032765	3220,- 135,-	023251	4690,- 196,-	023268

Individuálně podle charakteru a rozsahu zakázky možno dodat kování i v jiné rozteči. Cena se kalkuluje jako za plný štít.

Standardně dodáváno s pevnou koulí Maty. Zakázkově možnost sešroubování pomocí sešroubovacích pouzder skrze dveřní křídlo viz. Příslušenství a komponenty str. 377.



NRz nerez - broušeno

**Meclis**

1460,- Kč  
61,- EUR



TiN-K titan černý mat  
plný štítek

**Morgan**

1460,- Kč  
61,- EUR



**Cesan**

1620,- Kč  
68,- EUR

materiál: nerezová ocel  
povrch: NRz nerez - broušeno

**Kč** **EUR**

1460,-		61,-
1460,-		61,-
1910,-		80,-
2190,-		92,-
2190,-		92,-

1460,-		61,-
1460,-		61,-
1910,-		80,-
2190,-		92,-
2190,-		92,-
1750,-		73,-

1460,-		61,-
1460,-		61,-
1910,-		80,-
2190,-		92,-
2190,-		92,-

1460,-		61,-
1460,-		61,-
1910,-		80,-
2190,-		92,-
2190,-		92,-
1750,-		73,-

1620,-		68,-
1620,-		68,-
2050,-		86,-
2350,-		98,-
2350,-		98,-

1620,-		68,-
1620,-		68,-
2050,-		86,-
2350,-		98,-
2350,-		98,-
1910,-		80,-



	Objekt nerez			Objekt titan		Objekt		Projekt tř. 4, (i protipožární)		Projekt tř. 4, (i protipožární)	
	NRz			TiN-K		K-industrial		NRz		TiN-K	
	cena / pár	EAN		cena / pár	EAN	cena / pár	EAN	cena / pár	EAN	cena / pár	EAN
<b>72 mm</b>											
dozický	Kč €	1460,- 61,-	018295	2930,- 123,-	018349	2930,- 123,-	032772	1750,- 73,-	018394	3220,- 135,-	018448
cyldrický	Kč €	1460,- 61,-	018301	2930,- 123,-	018356	2930,- 123,-	032789	1750,- 73,-	018400	3220,- 135,-	018455
WC	Kč €	1910,- 80,-	018318	3380,- 141,-	018363	3380,- 141,-	032796	2190,- 92,-	018417	3660,- 153,-	018462
koule / klika R	Kč €	2190,- 92,-	018325	3660,- 153,-	018370	3660,- 153,-	032802	2490,- 104,-	018424	3950,- 165,-	018479
koule / klika L	Kč €	2190,- 92,-	018332	3660,- 153,-	018387	3660,- 153,-	032819	2490,- 104,-	018431	3950,- 165,-	018486
<b>90 mm</b>											
dozický	Kč €	1460,- 61,-	019292	2930,- 123,-	019346	2930,- 123,-	032826	1750,- 73,-	019391	3220,- 135,-	019445
cyldrický	Kč €	1460,- 61,-	019308	2930,- 123,-	019353	2930,- 123,-	032833	1750,- 73,-	019407	3220,- 135,-	019452
WC	Kč €	1910,- 80,-	019315	3380,- 141,-	019360	3380,- 141,-	032840	2190,- 92,-	019414	3660,- 153,-	019469
koule / klika R	Kč €	2190,- 92,-	019322	3660,- 153,-	019377	3660,- 153,-	032857	2490,- 104,-	019421	3950,- 165,-	019476
koule / klika L	Kč €	2190,- 92,-	019339	3660,- 153,-	019384	3660,- 153,-	032864	2490,- 104,-	019438	3950,- 165,-	019483
plný štítek	Kč €	1750,- 73,-	023275	3220,- 135,-	023282	3220,- 135,-	032871	2050,- 86,-	023299	3510,- 147,-	023305
<b>72 mm</b>											
dozický	Kč €	1460,- 61,-	018493	2930,- 123,-	018547	2930,- 123,-	032888	1750,- 73,-	018592	3220,- 135,-	018646
cyldrický	Kč €	1460,- 61,-	018509	2930,- 123,-	018554	2930,- 123,-	032895	1750,- 73,-	018608	3220,- 135,-	018653
WC	Kč €	1910,- 80,-	018516	3380,- 141,-	018561	3380,- 141,-	032901	2190,- 92,-	018615	3660,- 153,-	018660
koule / klika R	Kč €	2190,- 92,-	018523	3660,- 153,-	018578	3660,- 153,-	032918	2490,- 104,-	018622	3950,- 165,-	018677
koule / klika L	Kč €	2190,- 92,-	018530	3660,- 153,-	018585	3660,- 153,-	032925	2490,- 104,-	018639	3950,- 165,-	018684
<b>90 mm</b>											
dozický	Kč €	1460,- 61,-	019490	2930,- 123,-	019544	2930,- 123,-	032932	1750,- 73,-	019599	3220,- 135,-	019643
cyldrický	Kč €	1460,- 61,-	019506	2930,- 123,-	019551	2930,- 123,-	032949	1750,- 73,-	019605	3220,- 135,-	019650
WC	Kč €	1910,- 80,-	019513	3380,- 141,-	019568	3380,- 141,-	032956	2190,- 92,-	019612	3660,- 153,-	019667
koule / klika R	Kč €	2190,- 92,-	019520	3660,- 153,-	019575	3660,- 153,-	032963	2490,- 104,-	019629	3950,- 165,-	019674
koule / klika L	Kč €	2190,- 92,-	019537	3660,- 153,-	019582	3660,- 153,-	032970	2490,- 104,-	019636	3950,- 165,-	019681
plný štítek	Kč €	1750,- 73,-	023312	3220,- 135,-	023329	3220,- 135,-	032987	2050,- 86,-	023336	3510,- 147,-	023343
<b>72 mm</b>											
dozický	Kč €	1620,- 68,-	022759	3070,- 128,-	022803	3070,- 128,-	032994	1910,- 80,-	022858	3380,- 141,-	022902
cyldrický	Kč €	1620,- 68,-	022766	3070,- 128,-	022810	3070,- 128,-	033007	1910,- 80,-	022865	3380,- 141,-	022919
WC	Kč €	2050,- 86,-	022773	3510,- 147,-	022827	3510,- 147,-	033014	2350,- 98,-	022872	3810,- 159,-	022926
koule / klika R	Kč €	2350,- 98,-	022780	3810,- 159,-	022834	3810,- 159,-	033021	2640,- 110,-	022889	4100,- 171,-	022933
koule / klika L	Kč €	2350,- 98,-	022797	3810,- 159,-	022841	3810,- 159,-	033038	2640,- 110,-	022896	4100,- 171,-	022940
<b>90 mm</b>											
dozický	Kč €	1620,- 68,-	022957	3070,- 128,-	023008	3070,- 128,-	033045	1910,- 80,-	023053	3380,- 141,-	023107
cyldrický	Kč €	1620,- 68,-	022964	3070,- 128,-	023015	3070,- 128,-	033052	1910,- 80,-	023060	3380,- 141,-	023114
WC	Kč €	2050,- 86,-	022971	3510,- 147,-	023022	3510,- 147,-	033069	2350,- 98,-	023077	3810,- 159,-	023121
koule / klika R	Kč €	2350,- 98,-	022988	3810,- 159,-	023039	3810,- 159,-	033076	2640,- 110,-	023084	4100,- 171,-	023138
koule / klika L	Kč €	2350,- 98,-	022995	3810,- 159,-	023046	3810,- 159,-	033083	2640,- 110,-	023091	4100,- 171,-	023145
plný štítek	Kč €	1910,- 80,-	023350	3380,- 141,-	023367	3380,- 141,-	033090	2190,- 92,-	023374	3660,- 153,-	023381

Individuálně podle charakteru a rozsahu zakázky možno dodat kování i v jiné rozteči. Cena se kalkuluje jako za plný štít.  
Standardně dodáváno s pevnou koulí Maty. Zakázkově možnost sešroubování pomocí sešroubovacích pouzder skrze dveřní křídlo viz. Příslušenství a komponenty str. 377.



Celý projekt - jeden design

Štitové kování DESIGN 2000, 2004



Dveřní kliky DESIGN 2000, 2004



Kování pro hliníkové a ocelové dveře,  
kování na branky



Kliky a zámky  
na skleněné dveře



Madla a koule na skleněné  
a dřevěné dveře



Panty na skleněné dveře



Bezpečnostní rozety



Hranaté panty na dřevěné  
dveře



Mušle na posuvné  
dveře



Okenní kliky  
3 a 4 polohové



## Štitové kování DESIGN 2000, 2004

Materiál: masivní mosaz

Povrchy: SNi, Cr, TiN-C, TiN-K, Ms, Ms-L, zakázkově TiN-S, TiN-A  
více info na [www.kliky-mt.cz/manufaktura/barvy-povrchy](http://www.kliky-mt.cz/manufaktura/barvy-povrchy)

Štitové kování M&T je vyráběno v několika designech štítků se širokým využitím. Předností štitového kování M&T je možnost dodávek v požadovaných rozměrech/roztečích 72 a 90 mm i ve variantě plného štítu. Nadstandardně jsou připraveny kombinace s titanovým povrchem v několika barevných odstínech.

**BURAK SNi** matný nikl

**GARANTI SNi** matný nikl

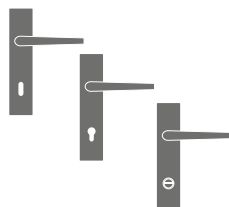

Klika/klika + štítky dozické

Klika/klika + štítky cylindrické

Klika/klika + štítky s WC mechanismem

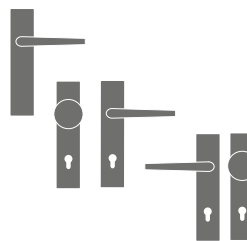

Klika/klika + plné štítky

Koule/klika R + štítky cylindrické

Koule/klika L + štítky cylindrické



dozické

cylindrické

WC in

WC ex

plný štít

s koulí Kemer

konstrukční varianty, materiálové provedení

- kování s vratnou pružinou
- kovový vnitřní štít
- nacvakávací krycí mosazný štít
- montáž na dveře do tl. 126 mm
- záruka 3 roky, titany 15 let

roky **3 garance** let **15 garance**

- kování s vratnou pružinou
- masivní mosazný štít
- montáž na dveře do tl. 126 mm
- záruka 3 roky, titany 15 let

roky **3 garance** let **15 garance**

Ochranná známka – registrovaná značka **ENTERO®**



Chráněné průmyslové vzory klik



**ENTERO**  
**BURAK**  
**MIA**  
**SOGUT**



SNi matný nikel

**Garanti**

1940,- Kč  
81,- EUR



Ms mosaz natural

**Sogut**

2220,- Kč  
93,- EUR



**Deny**

2020,- Kč  
85,- EUR



**KČ** materiál: masivní mosaz povrch: SNi matný nikel **EUR**

1940,-		81,-
1940,-		81,-
2510,-		105,-
2630,-		110,-
2630,-		110,-

1940,-		81,-
1940,-		81,-
2510,-		105,-
2630,-		110,-
2630,-		110,-
2260,-		95,-

2220,-		93,-
2220,-		93,-
2890,-		121,-
2940,-		123,-
2940,-		123,-

2220,-		93,-
2220,-		93,-
2890,-		121,-
2940,-		123,-
2940,-		123,-
2520,-		105,-

2020,-		85,-
2020,-		85,-
2720,-		114,-
2730,-		114,-
2730,-		114,-

2020,-		85,-
2020,-		85,-
2720,-		114,-
2730,-		114,-
2730,-		114,-
2350,-		98,-



		SNI		Cr		Ms		Ms-L		TiN-C		TiN-K	
		cena / pár	EAN	cena / pár	EAN	cena / pár	EAN	cena / pár	EAN	cena / pár	EAN	cena / pár	EAN
<b>72 mm</b>													
dozický	Kč €	1940,- 81,-	27305	2460,- 103,-	27398	2460,- 103,-	055450	2460,- 103,-	055504	2720,- 114,-	39919	3630,- 152,-	39964
cyldrický	Kč €	1940,- 81,-	27312	2460,- 103,-	27404	2460,- 103,-	055467	2460,- 103,-	055511	2720,- 114,-	39926	3630,- 152,-	39971
WC	Kč €	2510,- 105,-	27329	3020,- 126,-	27411	3020,- 126,-	055474	3020,- 126,-	055528	3350,- 140,-	39933	4530,- 189,-	39988
koule / klika R	Kč €	2630,- 110,-	27336	3130,- 131,-	27428	3130,- 131,-	055481	3130,- 131,-	055535	3720,- 155,-	39940	4650,- 194,-	39995
koule / klika L	Kč €	2630,- 110,-	27343	3130,- 131,-	27435	3130,- 131,-	055498	3130,- 131,-	055542	3720,- 155,-	39957	4650,- 194,-	40106
<b>90 mm</b>													
dozický	Kč €	1940,- 81,-	27350	2460,- 103,-	27442	2460,- 103,-	055559	2460,- 103,-	055610	2720,- 114,-	40205	3630,- 152,-	40243
cyldrický	Kč €	1940,- 81,-	27367	2460,- 103,-	27459	2460,- 103,-	055566	2460,- 103,-	055627	2720,- 114,-	40212	3630,- 152,-	40250
WC	Kč €	2510,- 105,-	40328	3020,- 126,-	40342	3020,- 126,-	055573	3020,- 126,-	055634	3350,- 140,-	40380	4530,- 189,-	40403
koule / klika R	Kč €	2630,- 110,-	27374	3130,- 131,-	27466	3130,- 131,-	055580	3130,- 131,-	055641	3720,- 155,-	40229	4650,- 194,-	40267
koule / klika L	Kč €	2630,- 110,-	27381	3130,- 131,-	27473	3130,- 131,-	055597	3130,- 131,-	055658	3720,- 155,-	40236	4650,- 194,-	40274
plný štítek	Kč €	2260,- 95,-	40335	2760,- 115,-	40359	2760,- 115,-	055603	2760,- 115,-	055665	2980,- 125,-	40397	3950,- 165,-	40410
<b>72 mm</b>													
dozický	Kč €	2220,- 93,-	24670	2730,- 114,-	33863	2730,- 114,-	055672	2730,- 114,-	055726	3010,- 126,-	33917	3910,- 163,-	24854
cyldrický	Kč €	2220,- 93,-	24687	2730,- 114,-	33870	2730,- 114,-	055689	2730,- 114,-	055733	3010,- 126,-	33924	3910,- 163,-	24861
WC	Kč €	2890,- 121,-	24694	3410,- 143,-	33887	3410,- 143,-	055696	3410,- 143,-	055740	3790,- 158,-	33931	4930,- 206,-	24878
koule / klika R	Kč €	2940,- 123,-	24700	3440,- 144,-	33894	3440,- 144,-	055702	3440,- 144,-	055757	4060,- 170,-	33948	4960,- 207,-	24885
koule / klika L	Kč €	2940,- 123,-	24717	3440,- 144,-	33900	3440,- 144,-	055719	3440,- 144,-	055764	4060,- 170,-	33955	4960,- 207,-	24892
<b>90 mm</b>													
dozický	Kč €	2220,- 93,-	24632	2730,- 114,-	33962	2730,- 114,-	055771	2730,- 114,-	055832	3010,- 126,-	34006	3910,- 163,-	24816
cyldrický	Kč €	2220,- 93,-	24649	2730,- 114,-	33979	2730,- 114,-	055788	2730,- 114,-	055849	3010,- 126,-	34013	3910,- 163,-	24823
WC	Kč €	2890,- 121,-	37526	3410,- 143,-	37540	3410,- 143,-	055795	3410,- 143,-	055856	3790,- 158,-	37588	4930,- 206,-	37601
koule / klika R	Kč €	2940,- 123,-	24656	3440,- 144,-	33986	3440,- 144,-	055801	3440,- 144,-	055863	4060,- 170,-	34020	4960,- 207,-	24830
koule / klika L	Kč €	2940,- 123,-	24663	3440,- 144,-	33993	3440,- 144,-	055818	3440,- 144,-	055870	4060,- 170,-	34037	4960,- 207,-	24847
plný štítek	Kč €	2520,- 105,-	37533	3030,- 127,-	37557	3030,- 127,-	055825	3030,- 127,-	055887	3310,- 138,-	37595	4220,- 176,-	37618
<b>72 mm</b>													
dozický	Kč €	2020,- 85,-	24946	2520,- 105,-	25196	2520,- 105,-	055894	2520,- 105,-	055948	2820,- 118,-	33498	3710,- 155,-	33542
cyldrický	Kč €	2020,- 85,-	24953	2520,- 105,-	25202	2520,- 105,-	055900	2520,- 105,-	055955	2820,- 118,-	33504	3710,- 155,-	33559
WC	Kč €	2720,- 114,-	24960	3220,- 135,-	25219	3220,- 135,-	055917	3220,- 135,-	055962	3590,- 150,-	33511	4740,- 198,-	33566
koule / klika R	Kč €	2730,- 114,-	24977	3230,- 135,-	25226	3230,- 135,-	055924	3230,- 135,-	055979	3890,- 163,-	33528	4750,- 198,-	33573
koule / klika L	Kč €	2730,- 114,-	24984	3230,- 135,-	25233	3230,- 135,-	055931	3230,- 135,-	055986	3890,- 163,-	33535	4750,- 198,-	33580
<b>90 mm</b>													
dozický	Kč €	2020,- 85,-	24908	2520,- 105,-	25158	2520,- 105,-	055993	2520,- 105,-	056051	2820,- 118,-	34082	3710,- 155,-	34129
cyldrický	Kč €	2020,- 85,-	24915	2520,- 105,-	25165	2520,- 105,-	056006	2520,- 105,-	056068	2820,- 118,-	34099	3710,- 155,-	34136
WC	Kč €	2720,- 114,-	39742	3220,- 135,-	39766	3220,- 135,-	056013	3220,- 135,-	056075	3590,- 150,-	39803	4740,- 198,-	39827
koule / klika R	Kč €	2730,- 114,-	24922	3230,- 135,-	25172	3230,- 135,-	056020	3230,- 135,-	056082	3890,- 163,-	34105	4750,- 198,-	34143
koule / klika L	Kč €	2730,- 114,-	24939	3230,- 135,-	25189	3230,- 135,-	056037	3230,- 135,-	056099	3890,- 163,-	34112	4750,- 198,-	34150
plný štítek	Kč €	2350,- 98,-	39759	2850,- 119,-	39773	2850,- 119,-	056044	2850,- 119,-	056105	3110,- 130,-	39810	4030,- 168,-	39834

Zakázkově možnost sešroubování pomocí sešroubovacích pouzder skrze dveřní křídlo u modelů Burak, Cesan, Meclis, viz. Příslušenství a komponenty str. 377.  
Standardně dodáváno s pevnou koulí Kemer, na základě požadavků s pevnou koulí Maty. Lze dodat s otočnou koulí Fábi (mimo štítových modelů Burak, Cesan, Meclis).



**Lusy**

2020,- Kč  
85,- EUR

SNi matný nikel



**Andy**

2220,- Kč  
93,- EUR

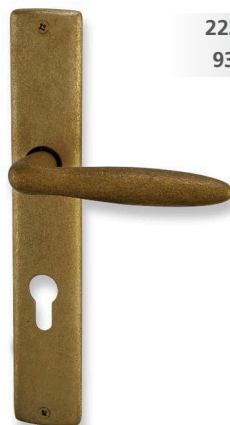

Ms mosaz natural



**Entero**

3670,- Kč  
153,- EUR

**Kč** materiál: masivní mosaz povrch: SNi matný nikel **EUR**

2020,-				85,-
2020,-				85,-
2720,-				114,-
2730,-				114,-
2730,-				114,-

2020,-				85,-
2020,-				85,-
2720,-				114,-
2730,-				114,-
2730,-				114,-
2350,-				98,-

2220,-				93,-
2220,-				93,-
2880,-				120,-
2940,-				123,-
2940,-				123,-

2220,-				93,-
2220,-				93,-
2880,-				120,-
2940,-				123,-
2940,-				123,-
2520,-				105,-

3670,-				153,-
3670,-				153,-
4270,-				178,-
4280,-				179,-
4280,-				179,-

3670,-				153,-
3670,-				153,-
4270,-				178,-
4280,-				179,-
4280,-				179,-
3910,-				163,-



		Sni		Cr		Ms		Ms-L		TiN-C		TiN-K	
		cena / pár	EAN	cena / pár	EAN	cena / pár	EAN	cena / pár	EAN	cena / pár	EAN	cena / pár	EAN
<b>72 mm</b>													
dozický	Kč €	2020,- 85,-	24496	2520,- 105,-	24588	2520,- 105,-	056112	2520,- 105,-	056167	2820,- 118,-	33641	3710,- 155,-	33696
cyldrický	Kč €	2020,- 85,-	24502	2520,- 105,-	24595	2520,- 105,-	056129	2520,- 105,-	056174	2820,- 118,-	33658	3710,- 155,-	33702
WC	Kč €	2720,- 114,-	24519	3220,- 135,-	24601	3220,- 135,-	056136	3220,- 135,-	056181	3590,- 150,-	33665	4740,- 198,-	33719
koule / klika R	Kč €	2730,- 114,-	24526	3230,- 135,-	24618	3230,- 135,-	056143	3230,- 135,-	056198	3890,- 163,-	33672	4750,- 198,-	33726
koule / klika L	Kč €	2730,- 114,-	24533	3230,- 135,-	24625	3230,- 135,-	056150	3230,- 135,-	056204	3890,- 163,-	33689	4750,- 198,-	33733
<b>90 mm</b>													
dozický	Kč €	2020,- 85,-	24458	2520,- 105,-	24540	2520,- 105,-	056211	2520,- 105,-	056273	2820,- 118,-	33788	3710,- 155,-	33825
cyldrický	Kč €	2020,- 85,-	24465	2520,- 105,-	24557	2520,- 105,-	056228	2520,- 105,-	056280	2820,- 118,-	33795	3710,- 155,-	33832
WC	Kč €	2720,- 114,-	39384	3220,- 135,-	39407	3220,- 135,-	056235	3220,- 135,-	056297	3590,- 150,-	39445	4740,- 198,-	39469
koule / klika R	Kč €	2730,- 114,-	24472	3230,- 135,-	24564	3230,- 135,-	056242	3230,- 135,-	056303	3890,- 163,-	33801	4750,- 198,-	33849
koule / klika L	Kč €	2730,- 114,-	24489	3230,- 135,-	24571	3230,- 135,-	056259	3230,- 135,-	056310	3890,- 163,-	33818	4750,- 198,-	33856
plný štítek	Kč €	2350,- 98,-	39391	2850,- 119,-	39414	2850,- 119,-	056266	2850,- 119,-	056327	3110,- 130,-	39452	4030,- 168,-	39476
<b>72 mm</b>													
dozický	Kč €	2220,- 93,-	40441	2730,- 114,-	40496	2730,- 114,-	056334	2730,- 114,-	056389	3010,- 126,-	40595	3910,- 163,-	40649
cyldrický	Kč €	2220,- 93,-	40458	2730,- 114,-	40502	2730,- 114,-	056341	2730,- 114,-	056396	3010,- 126,-	40601	3910,- 163,-	40656
WC	Kč €	2880,- 120,-	40465	3390,- 142,-	40519	3390,- 142,-	056358	3390,- 142,-	056402	3840,- 160,-	40618	4910,- 205,-	40663
koule / klika R	Kč €	2940,- 123,-	40472	3440,- 144,-	40526	3440,- 144,-	056365	3440,- 144,-	056419	4060,- 170,-	40625	4960,- 207,-	40670
koule / klika L	Kč €	2940,- 123,-	40489	3440,- 144,-	40533	3440,- 144,-	056372	3440,- 144,-	056426	4060,- 170,-	40632	4960,- 207,-	40687
<b>90 mm</b>													
dozický	Kč €	2220,- 93,-	40748	2730,- 114,-	40786	2730,- 114,-	056433	2730,- 114,-	056495	3010,- 126,-	40861	3910,- 163,-	40908
cyldrický	Kč €	2220,- 93,-	40755	2730,- 114,-	40793	2730,- 114,-	056440	2730,- 114,-	056501	3010,- 126,-	40878	3910,- 163,-	40915
WC	Kč €	2880,- 120,-	40984	3390,- 142,-	41004	3390,- 142,-	056457	3390,- 142,-	056518	3840,- 160,-	41042	4910,- 205,-	41066
koule / klika R	Kč €	2940,- 123,-	40762	3440,- 144,-	40809	3440,- 144,-	056464	3440,- 144,-	056525	4060,- 170,-	40885	4960,- 207,-	40922
koule / klika L	Kč €	2940,- 123,-	40779	3440,- 144,-	40816	3440,- 144,-	056471	3440,- 144,-	056532	4060,- 170,-	40892	4960,- 207,-	40939
plný štítek	Kč €	2520,- 105,-	40991	3030,- 127,-	41011	3030,- 127,-	056488	3030,- 127,-	056549	3310,- 138,-	41059	4220,- 176,-	41073
<b>72 mm</b>													
dozický	Kč €	3670,- 153,-	75412	4180,- 175,-	75467	4180,- 175,-	056556	4180,- 175,-	056600	4430,- 185,-	75566	5360,- 224,-	75610
cyldrický	Kč €	3670,- 153,-	75429	4180,- 175,-	75474	4180,- 175,-	056563	4180,- 175,-	056617	4430,- 185,-	75573	5360,- 224,-	75627
WC	Kč €	4270,- 178,-	75436	4780,- 200,-	75481	4780,- 200,-	056570	4780,- 200,-	056624	5130,- 214,-	75580	6310,- 263,-	75634
koule / klika R	Kč €	4280,- 179,-	75443	4790,- 200,-	75498	4790,- 200,-	056587	4790,- 200,-	056631	5390,- 225,-	75597	6320,- 264,-	75641
koule / klika L	Kč €	4280,- 179,-	75450	4790,- 200,-	75504	4790,- 200,-	056594	4790,- 200,-	056648	5390,- 225,-	75603	6320,- 264,-	75658
<b>90 mm</b>													
dozický	Kč €	3670,- 153,-	75665	4180,- 175,-	75726	4180,- 175,-	056655	4180,- 175,-	056716	4430,- 185,-	75849	5360,- 224,-	75900
cyldrický	Kč €	3670,- 153,-	75672	4180,- 175,-	75733	4180,- 175,-	056662	4180,- 175,-	056723	4430,- 185,-	75856	5360,- 224,-	75917
WC	Kč €	4270,- 178,-	75689	4780,- 200,-	75740	4780,- 200,-	056679	4780,- 200,-	056730	5130,- 214,-	75863	6310,- 263,-	75924
koule / klika R	Kč €	4280,- 179,-	75696	4790,- 200,-	75757	4790,- 200,-	056686	4790,- 200,-	056747	5390,- 225,-	75870	6320,- 264,-	75931
koule / klika L	Kč €	4280,- 179,-	75702	4790,- 200,-	75764	4790,- 200,-	056693	4790,- 200,-	056754	5390,- 225,-	75887	6320,- 264,-	75948
plný štítek	Kč €	3910,- 163,-	75719	4430,- 185,-	75771	4430,- 185,-	056709	4430,- 185,-	056761	4680,- 195,-	75894	5590,- 233,-	75955

Zakázkově možnost sešroubování pomocí sešroubovacích pouzder skrze dveřní křídlo u modelů Burak, Cesan, Meclis, viz. Příslušenství a komponenty str. 377.  
Standardně dodáváno s pevnou koulí Kemer, na základě požadavků s pevnou koulí Maty. Lze dodat s otočnou koulí Fábi (mimo štítových modelů Burak, Cesan, Meclis).



SNi matný nikel



**Mondeo**

2640,- Kč  
110,- EUR

**Cherez**

2890,- Kč  
121,- EUR

**Burak**

1830,- Kč  
77,- EUR

**KČ** materiál: masivní mosaz povrch: SNi matný nikel **EUR**

2640,-				110,-
2640,-				110,-
3280,-				137,-
3310,-				138,-
3310,-				138,-

2640,-				110,-
2640,-				110,-
3280,-				137,-
3310,-				138,-
3310,-				138,-
2940,-				123,-

2890,-				121,-
2890,-				121,-
3520,-				147,-
3530,-				148,-
3530,-				148,-

2890,-				121,-
2890,-				121,-
3520,-				147,-
3530,-				148,-
3530,-				148,-
3190,-				133,-

1830,-				77,-
1830,-				77,-
2410,-				101,-
2520,-				105,-
2520,-				105,-

1830,-				77,-
1830,-				77,-
2410,-				101,-
2520,-				105,-
2520,-				105,-
2140,-				90,-





		SNI		Cr		Ms		Ms-L		TiN-C		TiN-K	
		cena / pár	EAN	cena / pár	EAN	cena / pár	EAN	cena / pár	EAN	cena / pár	EAN	cena / pár	EAN
<b>72 mm</b>													
dozický	Kč €	2640,- 110,-	41769	3140,- 131,-	41813	3140,- 131,-	056778	3140,- 131,-	056822	3440,- 144,-	41912	4320,- 180,-	41967
cyldrický	Kč €	2640,- 110,-	41776	3140,- 131,-	41820	3140,- 131,-	056785	3140,- 131,-	056839	3440,- 144,-	41929	4320,- 180,-	41974
WC	Kč €	3280,- 137,-	41783	3780,- 158,-	41837	3780,- 158,-	056792	3780,- 158,-	056846	4230,- 177,-	41936	5300,- 221,-	41981
koule / klika R	Kč €	3310,- 138,-	41790	3810,- 159,-	41844	3810,- 159,-	056808	3810,- 159,-	056853	4460,- 186,-	41943	5340,- 223,-	41998
koule / klika L	Kč €	3310,- 138,-	41806	3810,- 159,-	41851	3810,- 159,-	056815	3810,- 159,-	056860	4460,- 186,-	41950	5340,- 223,-	42001
<b>90 mm</b>													
dozický	Kč €	2640,- 110,-	42063	3140,- 131,-	42100	3140,- 131,-	056877	3140,- 131,-	056938	3440,- 144,-	42186	4320,- 180,-	42223
cyldrický	Kč €	2640,- 110,-	42070	3140,- 131,-	42117	3140,- 131,-	056884	3140,- 131,-	056945	3440,- 144,-	42193	4320,- 180,-	42230
WC	Kč €	3280,- 137,-	42308	3780,- 158,-	42322	3780,- 158,-	056891	3780,- 158,-	056952	4230,- 177,-	42360	5300,- 221,-	42384
koule / klika R	Kč €	3310,- 138,-	42087	3810,- 159,-	42124	3810,- 159,-	056907	3810,- 159,-	056969	4460,- 186,-	42209	5340,- 223,-	42247
koule / klika L	Kč €	3310,- 138,-	42094	3810,- 159,-	42131	3810,- 159,-	056914	3810,- 159,-	056976	4460,- 186,-	42216	5340,- 223,-	42254
plný štítek	Kč €	2940,- 123,-	42315	3440,- 144,-	42339	3440,- 144,-	056921	3440,- 144,-	056983	3700,- 155,-	42377	4620,- 193,-	42391
<b>72 mm</b>													
dozický	Kč €	2890,- 121,-	74750	3410,- 143,-	74804	3410,- 143,-	056990	3410,- 143,-	057041	3670,- 153,-	74903	4570,- 191,-	74958
cyldrický	Kč €	2890,- 121,-	74767	3410,- 143,-	74811	3410,- 143,-	057003	3410,- 143,-	057058	3670,- 153,-	74910	4570,- 191,-	74965
WC	Kč €	3520,- 147,-	74774	4030,- 168,-	74828	4030,- 168,-	057010	4030,- 168,-	057065	4400,- 184,-	74927	5550,- 232,-	74972
koule / klika R	Kč €	3530,- 148,-	74781	4040,- 169,-	74835	4040,- 169,-	057027	4040,- 169,-	057072	4680,- 195,-	74934	5560,- 232,-	74989
koule / klika L	Kč €	3530,- 148,-	74798	4040,- 169,-	74842	4040,- 169,-	057034	4040,- 169,-	057089	4680,- 195,-	74941	5560,- 232,-	74996
<b>90 mm</b>													
dozický	Kč €	2890,- 121,-	75054	3410,- 143,-	75115	3410,- 143,-	057096	3410,- 143,-	057157	3670,- 153,-	75238	4570,- 191,-	75290
cyldrický	Kč €	2890,- 121,-	75061	3410,- 143,-	75122	3410,- 143,-	057102	3410,- 143,-	057164	3670,- 153,-	75245	4570,- 191,-	75306
WC	Kč €	3520,- 147,-	75078	4030,- 168,-	75139	4030,- 168,-	057119	4030,- 168,-	057171	4400,- 184,-	75252	5550,- 232,-	75313
koule / klika R	Kč €	3530,- 148,-	75085	4040,- 169,-	75146	4040,- 169,-	057126	4040,- 169,-	057188	4680,- 195,-	75269	5560,- 232,-	75320
koule / klika L	Kč €	3530,- 148,-	75092	4040,- 169,-	75153	4040,- 169,-	057133	4040,- 169,-	057195	4680,- 195,-	75276	5560,- 232,-	75337
plný štítek	Kč €	3190,- 133,-	75108	3690,- 154,-	75160	3690,- 154,-	057140	3690,- 154,-	057201	3910,- 163,-	75283	4870,- 203,-	75344
<b>72 mm</b>													
dozický	Kč €	1830,- 77,-	70820	2320,- 97,-	70875	2320,- 97,-	057218	2320,- 97,-	057263	2640,- 110,-	70974	3510,- 147,-	71025
cyldrický	Kč €	1830,- 77,-	70837	2320,- 97,-	70882	2320,- 97,-	057225	2320,- 97,-	057270	2640,- 110,-	70981	3510,- 147,-	71032
WC	Kč €	2410,- 101,-	70844	2940,- 123,-	70899	2940,- 123,-	057232	2940,- 123,-	057287	3310,- 138,-	70998	4450,- 186,-	71049
koule / klika R	Kč €	2520,- 105,-	70851	3030,- 127,-	70905	3030,- 127,-	057249	3030,- 127,-	057294	3700,- 155,-	71001	4550,- 190,-	71056
koule / klika L	Kč €	2520,- 105,-	70868	3030,- 127,-	70912	3030,- 127,-	057256	3030,- 127,-	057300	3700,- 155,-	71018	4550,- 190,-	71063
<b>90 mm</b>													
dozický	Kč €	1830,- 77,-	71124	2320,- 97,-	71186	2320,- 97,-	057317	2320,- 97,-	057379	2640,- 110,-	71308	3510,- 147,-	71360
cyldrický	Kč €	1830,- 77,-	71131	2320,- 97,-	71193	2320,- 97,-	057324	2320,- 97,-	057386	2640,- 110,-	71315	3510,- 147,-	71377
WC	Kč €	2410,- 101,-	71148	2940,- 123,-	71209	2940,- 123,-	057331	2940,- 123,-	057393	3310,- 138,-	71322	4450,- 186,-	71384
koule / klika R	Kč €	2520,- 105,-	71155	3030,- 127,-	71216	3030,- 127,-	057348	3030,- 127,-	057409	3700,- 155,-	71339	4550,- 190,-	71391
koule / klika L	Kč €	2520,- 105,-	71162	3030,- 127,-	71223	3030,- 127,-	057355	3030,- 127,-	057416	3700,- 155,-	71346	4550,- 190,-	71407
plný štítek	Kč €	2140,- 90,-	71179	2650,- 111,-	71230	2650,- 111,-	057362	2650,- 111,-	057423	2940,- 123,-	71353	3820,- 160,-	71414

Zakázkově možnost sešroubování pomocí sešroubovacích pouzder skrze dveřní křídlo u modelů Burak, Cesan, Meclis, viz. Příslušenství a komponenty str. 377.  
Standardně dodáváno s pevnou koulí Kemer, na základě požadavků s pevnou koulí Maty. Lze dodat s otočnou koulí Fábi (mimo štítových modelů Burak, Cesan, Meclis).



SNi matný nikl



Ms mosaz natural

**Mia**

2020,- Kč  
85,- EUR



**Meclis**

1830,- Kč  
77,- EUR



**Cesan**

1580,- Kč  
66,- EUR

**KČ** materiál: masivní mosaz povrch: SNi matný nikl **EUR**

2020,-		85,-
2020,-		85,-
2720,-		114,-
2730,-		114,-
2730,-		114,-

2020,-		85,-
2020,-		85,-
2720,-		114,-
2730,-		114,-
2730,-		114,-
2350,-		98,-

1830,-		77,-
1830,-		77,-
2410,-		101,-
2520,-		105,-
2520,-		105,-

1830,-		77,-
1830,-		77,-
2410,-		101,-
2520,-		105,-
2520,-		105,-
2140,-		90,-

1580,-		66,-
1580,-		66,-
2140,-		90,-
2260,-		95,-
2260,-		95,-

1580,-		66,-
1580,-		66,-
2140,-		90,-
2260,-		95,-
2260,-		95,-
1860,-		78,-



		Sni		Cr		Ms		Ms-L		TiN-C		TiN-K	
		cena / pár	EAN	cena / pár	EAN	cena / pár	EAN	cena / pár	EAN	cena / pár	EAN	cena / pár	EAN
<b>72 mm</b>													
dozický	Kč €	2020,- 85,-	38127	2520,- 105,-	38172	2520,- 105,-	057430	2520,- 105,-	057485	2820,- 118,-	38271	3710,- 155,-	38325
cyldrický	Kč €	2020,- 85,-	38134	2520,- 105,-	38189	2520,- 105,-	057447	2520,- 105,-	057492	2820,- 118,-	38288	3710,- 155,-	38332
WC	Kč €	2720,- 114,-	38141	3220,- 135,-	38196	3220,- 135,-	057454	3220,- 135,-	057508	3590,- 150,-	38295	4740,- 198,-	38349
koule / klika R	Kč €	2730,- 114,-	38158	3230,- 135,-	38202	3230,- 135,-	057461	3230,- 135,-	057515	3890,- 163,-	38301	4750,- 198,-	38356
koule / klika L	Kč €	2730,- 114,-	38165	3230,- 135,-	38219	3230,- 135,-	057478	3230,- 135,-	057522	3890,- 163,-	38318	4750,- 198,-	38363
<b>90 mm</b>													
dozický	Kč €	2020,- 85,-	38424	2520,- 105,-	38462	2520,- 105,-	057539	2520,- 105,-	057591	2820,- 118,-	38547	3710,- 155,-	38585
cyldrický	Kč €	2020,- 85,-	38431	2520,- 105,-	38479	2520,- 105,-	057546	2520,- 105,-	057607	2820,- 118,-	38554	3710,- 155,-	38592
WC	Kč €	2720,- 114,-	39506	3220,- 135,-	39520	3220,- 135,-	057553	3220,- 135,-	057614	3590,- 150,-	39568	4740,- 198,-	39582
koule / klika R	Kč €	2730,- 114,-	38448	3230,- 135,-	38486	3230,- 135,-	057560	3230,- 135,-	057621	3890,- 163,-	38561	4750,- 198,-	38608
koule / klika L	Kč €	2730,- 114,-	38455	3230,- 135,-	38493	3230,- 135,-	057577	3230,- 135,-	057638	3890,- 163,-	38578	4750,- 198,-	38615
plný štítek	Kč €	2350,- 98,-	39513	2850,- 119,-	39537	2850,- 119,-	057584	2850,- 119,-	057645	3110,- 130,-	39575	4030,- 168,-	39599
<b>72 mm</b>													
dozický	Kč €	1830,- 77,-	24311	2320,- 97,-	24403	2320,- 97,-	057652	2320,- 97,-	057706	2640,- 110,-	33221	3510,- 147,-	33276
cyldrický	Kč €	1830,- 77,-	24328	2320,- 97,-	24410	2320,- 97,-	057669	2320,- 97,-	057713	2640,- 110,-	33238	3510,- 147,-	33283
WC	Kč €	2410,- 101,-	24335	2940,- 123,-	24427	2940,- 123,-	057676	2940,- 123,-	057720	3310,- 138,-	33245	4450,- 186,-	33290
koule / klika R	Kč €	2520,- 105,-	24342	3030,- 127,-	24434	3030,- 127,-	057683	3030,- 127,-	057737	3700,- 155,-	33252	4550,- 190,-	33306
koule / klika L	Kč €	2520,- 105,-	24359	3030,- 127,-	24441	3030,- 127,-	057690	3030,- 127,-	057744	3700,- 155,-	33269	4550,- 190,-	33313
<b>90 mm</b>													
dozický	Kč €	1830,- 77,-	24274	2320,- 97,-	24366	2320,- 97,-	057751	2320,- 97,-	057812	2640,- 110,-	33368	3510,- 147,-	33405
cyldrický	Kč €	1830,- 77,-	24281	2320,- 97,-	24373	2320,- 97,-	057768	2320,- 97,-	057829	2640,- 110,-	33375	3510,- 147,-	33412
WC	Kč €	2410,- 101,-	42513	2940,- 123,-	42537	2940,- 123,-	057775	2940,- 123,-	057836	3310,- 138,-	42575	4450,- 186,-	42599
koule / klika R	Kč €	2520,- 105,-	24298	3030,- 127,-	24380	3030,- 127,-	057782	3030,- 127,-	057843	3700,- 155,-	33382	4550,- 190,-	33429
koule / klika L	Kč €	2520,- 105,-	24304	3030,- 127,-	24397	3030,- 127,-	057799	3030,- 127,-	057850	3700,- 155,-	33399	4550,- 190,-	33436
plný štítek	Kč €	2140,- 90,-	42520	2650,- 111,-	42544	2650,- 111,-	057805	2650,- 111,-	057867	2940,- 123,-	42582	3820,- 160,-	42605
<b>72 mm</b>													
dozický	Kč €	1580,- 66,-	71483	2090,- 88,-	71537	2090,- 88,-	057874	2090,- 88,-	057928	2320,- 97,-	71636	3260,- 136,-	71681
cyldrický	Kč €	1580,- 66,-	71490	2090,- 88,-	71544	2090,- 88,-	057881	2090,- 88,-	057935	2320,- 97,-	71643	3260,- 136,-	71698
WC	Kč €	2140,- 90,-	71506	2650,- 111,-	71551	2650,- 111,-	057898	2650,- 111,-	057942	2980,- 125,-	71650	4180,- 175,-	71704
koule / klika R	Kč €	2260,- 95,-	71513	2760,- 115,-	71568	2760,- 115,-	057904	2760,- 115,-	057959	3350,- 140,-	71667	4270,- 178,-	71711
koule / klika L	Kč €	2260,- 95,-	71520	2760,- 115,-	71575	2760,- 115,-	057911	2760,- 115,-	057966	3350,- 140,-	71674	4270,- 178,-	71728
<b>90 mm</b>													
dozický	Kč €	1580,- 66,-	71780	2090,- 88,-	71841	2090,- 88,-	057973	2090,- 88,-	058031	2320,- 97,-	71964	3260,- 136,-	72022
cyldrický	Kč €	1580,- 66,-	71797	2090,- 88,-	71858	2090,- 88,-	057980	2090,- 88,-	058048	2320,- 97,-	71971	3260,- 136,-	72039
WC	Kč €	2140,- 90,-	71803	2650,- 111,-	71865	2650,- 111,-	057997	2650,- 111,-	058055	2980,- 125,-	71988	4180,- 175,-	72046
koule / klika R	Kč €	2260,- 95,-	71810	2760,- 115,-	71872	2760,- 115,-	058000	2760,- 115,-	058062	3350,- 140,-	71995	4270,- 178,-	72053
koule / klika L	Kč €	2260,- 95,-	71827	2760,- 115,-	71889	2760,- 115,-	058017	2760,- 115,-	058079	3350,- 140,-	72008	4270,- 178,-	72060
plný štítek	Kč €	1860,- 78,-	71834	2380,- 100,-	71896	2380,- 100,-	058024	2380,- 100,-	058086	2630,- 110,-	72015	3540,- 148,-	72077

Zakázkově možnost sešroubování pomocí sešroubovacích pouzder skrze dveřní křídlo u modelů Burak, Cesan, Meclis, viz. Příslušenství a komponenty str. 377.  
Standardně dodáváno s pevnou koulí Kemer, na základě požadavků s pevnou koulí Maty. Lze dodat s otočnou koulí Fábi (mimo štítových modelů Burak, Cesan, Meclis).



Příbuzný sortiment

Bezpečnostní vložky EVVA

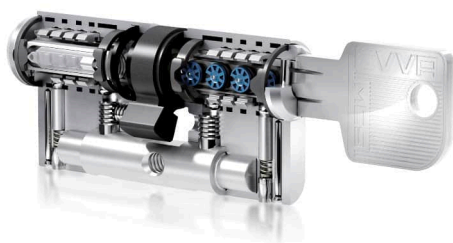

## Bezpečnostní štítové kování

Materiál: masivní mosaz

Povrchy: **SNi, Cr, TiN-C, TiN-K, Ms, zakázkově TiN-S, TiN-A**  
více info na [www.kliky-mt.cz/manufaktura/barvy-povrchy](http://www.kliky-mt.cz/manufaktura/barvy-povrchy)

Materiál: **nerezová ocel**

Povrchy: **NRz** nerez - broušeno, **TiN-K**

Bezpečnostní štíty M&T jsou připraveny pro všechny standardní projekty se širokou škálou použití. Předností je rozměrová variabilita pro běžné typy zámků s roztečí 72, 90 a 92 mm a barevnostní nabídka ve všech typech povrchů M&T. Kování Sicura lze kombinovat s jakoukoliv nerezovou klikou M&T a zároveň s jakoukoliv mosaznou klikou z produkce M&T.

SICURA **TiN-K** titan černý mat

SICURA **NRz** nerez broušeno

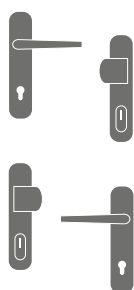

Madlo/klika R

Madlo/klika L

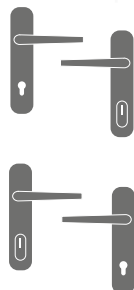

Klika/klika R

Klika/klika L

konstrukční varianty, materiálové provedení

- s krytkou cylindrické vložky
- z materiálů odolných proti rozlomení a vytržení
- maximální výstup cylindrické vložky z vnější strany max. 18 mm
- z vnitřní strany doporučený výstup 9 mm u štítů Sicura
- orientace kliky **R** pravá nebo **L** levá se určuje podle vnitřní kliky
- s montáží pro dveře 38 – 85 mm
- záruka 3 roky, nerez 5 let, titany 15 let

roky **3 garance** let **5 garance** let **15 garance**

Certifikace: bezpečnostní certifikáty státem akreditované zkušebny Trezor Test.

Certifikáty lze stáhnout na [www.kliky-mt.cz/certifikaty](http://www.kliky-mt.cz/certifikaty)



SNi matný nikel

**Bezpečnostní kování  
Burak Sicura**

5440,- Kč  
227,- EUR

**klika / klika**

**madlo / klika**

Kč	materiál: masivní mosaz povrch: SNi matný nikel	EUR
5440,-		227,-
5440,-		227,-
5440,-		227,-
5440,-		227,-
5440,-		227,-
5440,-		227,-
5440,-		227,-
5440,-		227,-
5440,-		227,-
5440,-		227,-



**klika volitelná**

**Bezpečnostní kování  
Sicura**

6050,- Kč  
253,- EUR

**klika / klika  
volitelná**

**madlo / klika  
volitelná**

6050,-		253,-
6050,-		253,-
6050,-		253,-
6050,-		253,-
6050,-		253,-
6050,-		253,-
6050,-		253,-
6050,-		253,-
6050,-		253,-
6050,-		253,-



		Sni		Cr		Ms		TiN-C		TiN-K	
		cena / pár	EAN	cena / pár	EAN	cena / pár	EAN	cena / pár	EAN	cena / pár	EAN
bezp. klika / klika R 72 mm	Kč €	5440,- 227,-	80614	5440,- 227,-	80676	5440,- 227,-	058093	6210,- 259,-	80799	6520,- 272,-	80850
bezp. klika / klika L 72 mm	Kč €	5440,- 227,-	80621	5440,- 227,-	80683	5440,- 227,-	058109	6210,- 259,-	80805	6520,- 272,-	80867
bezp. klika / klika R 90 mm	Kč €	5440,- 227,-	80638	5440,- 227,-	80690	5440,- 227,-	058116	6210,- 259,-	80812	6520,- 272,-	80874
bezp. klika / klika L 90 mm	Kč €	5440,- 227,-	80645	5440,- 227,-	80706	5440,- 227,-	058123	6210,- 259,-	80829	6520,- 272,-	80881
bezp. klika / klika R 92 mm	Kč €	5440,- 227,-	80652	5440,- 227,-	80713	5440,- 227,-	058130	6210,- 259,-	80836	6520,- 272,-	80898
bezp. klika / klika L 92 mm	Kč €	5440,- 227,-	80669	5440,- 227,-	80720	5440,- 227,-	058147	6210,- 259,-	80843	6520,- 272,-	80904
bezp. madlo / klika R 72 mm	Kč €	5440,- 227,-	80973	5440,- 227,-	81031	5440,- 227,-	058215	6210,- 259,-	81154	6520,- 272,-	81215
bezp. madlo / klika L 72 mm	Kč €	5440,- 227,-	80980	5440,- 227,-	81048	5440,- 227,-	058222	6210,- 259,-	81161	6520,- 272,-	81222
bezp. madlo / klika R 90 mm	Kč €	5440,- 227,-	80997	5440,- 227,-	81055	5440,- 227,-	058239	6210,- 259,-	81178	6520,- 272,-	81239
bezp. madlo / klika L 90 mm	Kč €	5440,- 227,-	81000	5440,- 227,-	81062	5440,- 227,-	058246	6210,- 259,-	81185	6520,- 272,-	81246
bezp. madlo / klika R 92 mm	Kč €	5440,- 227,-	81017	5440,- 227,-	81079	5440,- 227,-	058253	6210,- 259,-	81192	6520,- 272,-	81253
bezp. madlo / klika L 92 mm	Kč €	5440,- 227,-	81024	5440,- 227,-	81086	5440,- 227,-	058260	6210,- 259,-	81208	6520,- 272,-	81260



		Sni		Cr		Ms		TiN-C		TiN-K		NRz	
		cena / pár	EAN	cena / pár	EAN	cena / pár	EAN	cena / pár	EAN	cena / pár	EAN	cena / pár	EAN
bezp. klika / klika R 72 mm	Kč €	6050,- 253,-	82052	6050,- 253,-	82113	6050,- 253,-	058338	6830,- 285,-	82236	7150,- 298,-	82298	3990,- 167,-	080568
bezp. klika / klika L 72 mm	Kč €	6050,- 253,-	82069	6050,- 253,-	82120	6050,- 253,-	058345	6830,- 285,-	82243	7150,- 298,-	82304	3990,- 167,-	080575
bezp. klika / klika R 90 mm	Kč €	6050,- 253,-	82076	6050,- 253,-	82137	6050,- 253,-	058352	6830,- 285,-	82250	7150,- 298,-	82311	3990,- 167,-	080582
bezp. klika / klika L 90 mm	Kč €	6050,- 253,-	82083	6050,- 253,-	82144	6050,- 253,-	058369	6830,- 285,-	82267	7150,- 298,-	82328	3990,- 167,-	080599
bezp. klika / klika R 92 mm	Kč €	6050,- 253,-	82090	6050,- 253,-	82151	6050,- 253,-	058376	6830,- 285,-	82274	7150,- 298,-	82335	3990,- 167,-	080605
bezp. klika / klika L 92 mm	Kč €	6050,- 253,-	82106	6050,- 253,-	82168	6050,- 253,-	058383	6830,- 285,-	82281	7150,- 298,-	82342	3990,- 167,-	080612
bezp. madlo / klika R 72 mm	Kč €	6050,- 253,-	82410	6050,- 253,-	82472	6050,- 253,-	058451	6830,- 285,-	82595	7150,- 298,-	82656	3990,- 167,-	080629
bezp. madlo / klika L 72 mm	Kč €	6050,- 253,-	82427	6050,- 253,-	82489	6050,- 253,-	058468	6830,- 285,-	82601	7150,- 298,-	82663	3990,- 167,-	080636
bezp. madlo / klika R 90 mm	Kč €	6050,- 253,-	82434	6050,- 253,-	82496	6050,- 253,-	058475	6830,- 285,-	82618	7150,- 298,-	82670	3990,- 167,-	080643
bezp. madlo / klika L 90 mm	Kč €	6050,- 253,-	82441	6050,- 253,-	82502	6050,- 253,-	058482	6830,- 285,-	82625	7150,- 298,-	82687	3990,- 167,-	080650
bezp. madlo / klika R 92 mm	Kč €	6050,- 253,-	82458	6050,- 253,-	82519	6050,- 253,-	058499	6830,- 285,-	82632	7150,- 298,-	82694	3990,- 167,-	080667
bezp. madlo / klika L 92 mm	Kč €	6050,- 253,-	82465	6050,- 253,-	82526	6050,- 253,-	058505	6830,- 285,-	82649	7150,- 298,-	82700	3990,- 167,-	080674

Bezpečnostní kování Sicura je možné kombinovat s jakoukoliv rukojetí / klikou z produkce M&T včetně nerezových klik. Klika není s vratnou pružinou.



## Příbuzný sortiment

### Bezpečnostní vložky EVVA



### Jednostranné kliky

DESIGN 2006  
DESIGN 2009  
DESIGN 2011  
DESIGN 2013  
Kování pro Al dveře

Příslušenství a komponenty  
Rozpěrný čtyřhran



## Bezpečnostní madla Entero s integrovanou rozetou

Materiál: nerezová ocel

Povrchy: NRz nerez - broušeno, K-industrial černý mat strukturovaný, TiN-C

Dveřní madla M&T s patentovaným inovativním řešením, kdy jsou veškeré potřebné funkce soustředěny do jednoho minimalistického funkčního celku. Bezpečnostní madlo Entero plní funkci jak ovládací – pomocí úchopné části madla, tak uzamykací – pomocí integrované rozety s požadovanou bezpečností. To vše na velmi malém prostoru, ale s maximální bezpečností a komfortem ovládní s důrazem na minimalistický design produktu. Pro různé typy dveří a pro různé požadavky na ovládní lze madla dodávat v individuálních délkách s možností povrchové titanové úpravy v žádaných barevných odstínech. Bezpečnostní madlo se dodává v kombinaci s rozetovým kováním z vnitřní strany dveří podle výběru z produkce M&T. Zcela komplexní řešení pro dokonale vzhled vstupních dveří.

Bezpečnostní madlo Entero **NRz** nerez ocel - broušeno

Bezpeč. madlo Entero 350 mm **K-industrial** černý mat strukturovaný

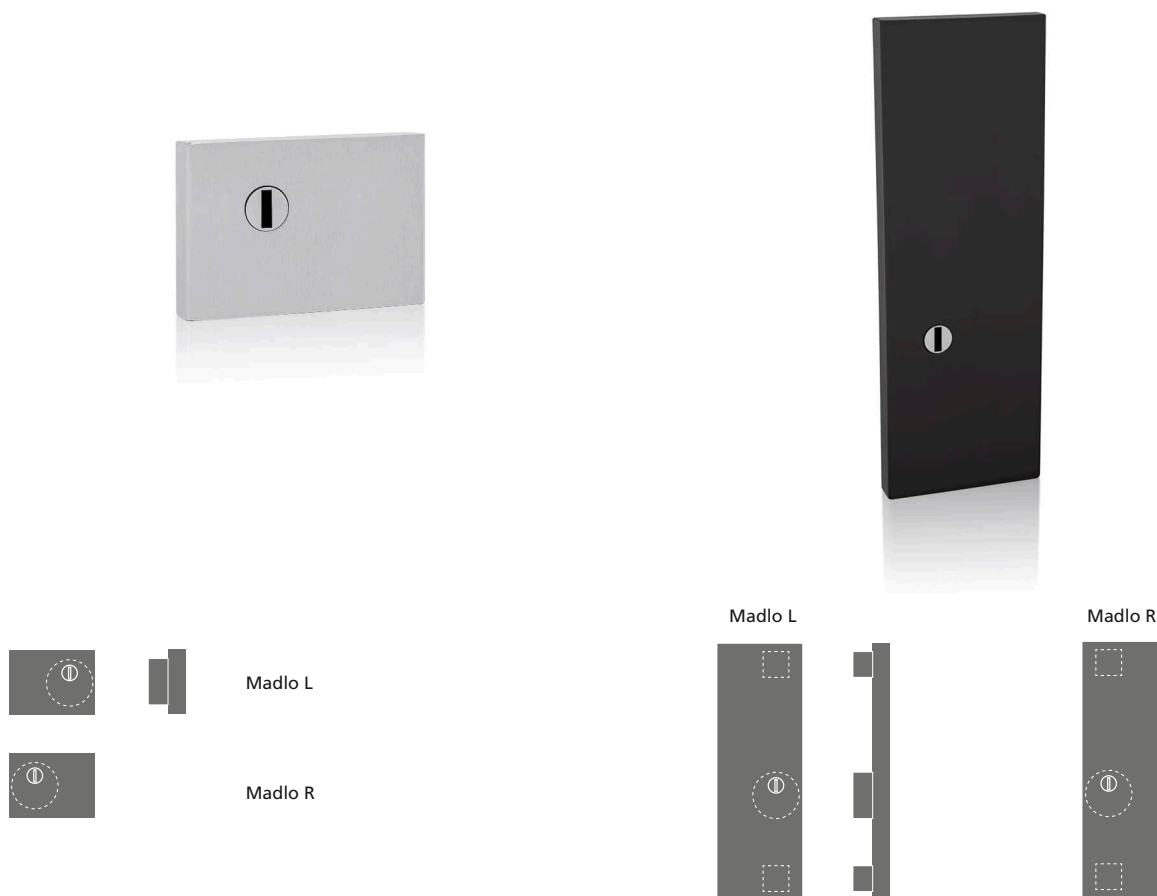

### konstrukční varianty, materiálové provedení

- s bezpečnostní krytkou cylindrické vložky
- maximální výstup cylindrické vložky z vnější strany dveří max. 37,5 mm
- doporučený výstup cylindrické vložky z vnitřní strany dveří 11 mm
- Bezpečnostní madlo se kombinuje s jednostrannou rozetovou klikou z produkce M&T
- montážně pro všechny typy zámků bez nutnosti určení rozměru/rozteče zámku
- zakázkově lze dodat madla až do délky 3000 mm v povrchu NRz, 2500 mm v povrchu K-industrial a 1000 mm v povrchu TiN-C
- madla od délky 350 mm se dodávají také oboustranné (do páru)
- madla jsou ve variantě R pravá, nebo L levá
- patentovaný konstrukční systém
- vrtání s PROFI šablonou M&T
- velmi rychlá a snadná montáž
- technické výkresy, výkresy vrtání na [www.kliky-mt.cz/montaze-kovani](http://www.kliky-mt.cz/montaze-kovani)
- montáž pro tloušťky dveří 38 – 126 mm
- záruka NRz, K-industrial 5 let, TiN-C 15 let

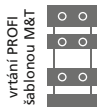

Ochranná známka – registrovaná značka

ENTERO®



Chráněné průmyslové vzory



madlo ENTERO  
madlo ENTERO 350  
madlo ENTERO 1000

Patent

konstrukce systému



let **5 garance**

let **15 garance**

Pro maximální bezpečnost doporučujeme kombinovat bezpečnostní madla Entero s cylindrickými vložkami EVVA.

Certifikace: bezpečnostní certifikáty státem akreditované zkušebny Trezor Test a NBÚ (Národní bezpečnostní úřad).

Certifikáty lze stáhnout na [www.kliky-mt.cz/katalog/bezpecnostni-madla-entero/](http://www.kliky-mt.cz/katalog/bezpecnostni-madla-entero/) u jednotlivých produktů.



NRz nerez - broušeno

**Bezpečnostní madlo Entero**

5720,- Kč  
239,- EUR

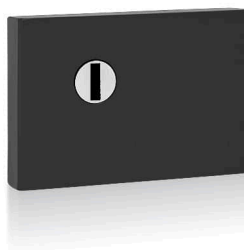

K-industrial černý mat strukturovaný

materiál: nerezová ocel  
KČ povrch: NRz nerez - broušeno EUR

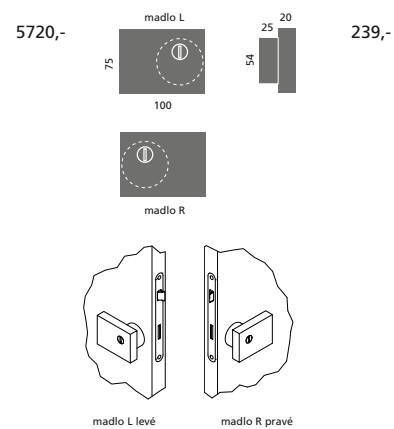

**Bezpečnostní madlo Entero 350 mm**

8640,- Kč  
360,- EUR

materiál: nerezová ocel  
KČ povrch: NRz nerez - broušeno EUR

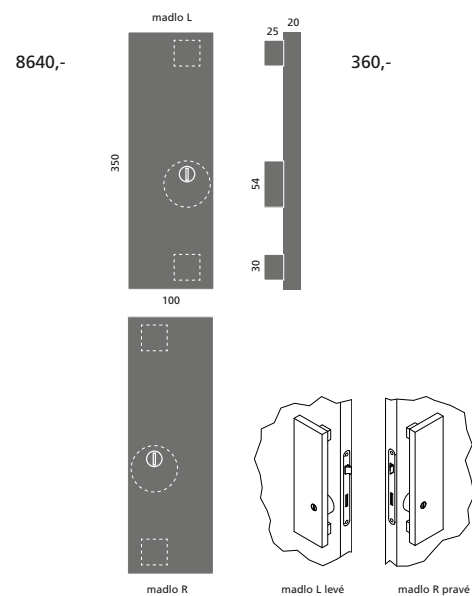

**Ochranné madlo Entero 350 mm pro Al dveře**

8640,- Kč  
360,- EUR

materiál: nerezová ocel  
KČ povrch: NRz nerez - broušeno EUR

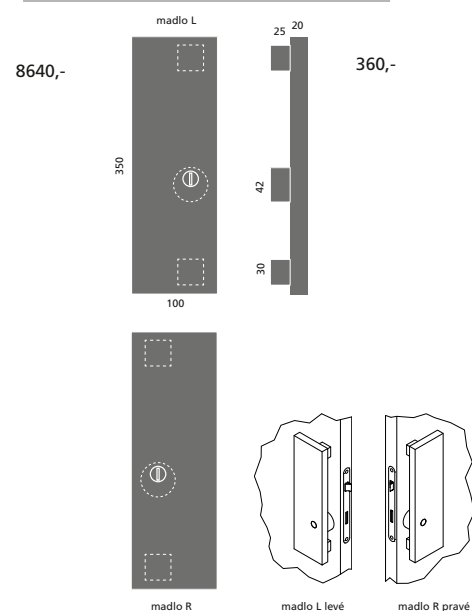

			NRz		TiN-C		K-industrial	
			cena	EAN	cena	EAN	cena	EAN
pro tl. dveří 38 - 45 mm	madlo L	Kč €	5720,- 239,-	035278	6860,- 286,-	035339	8190,- 342,-	035315
	madlo R	Kč €	5720,- 239,-	035285	6860,- 286,-	035346	8190,- 342,-	035322
pro tl. dveří 46 - 52 mm	madlo L	Kč €	5870,- 245,-	035353	7000,- 292,-	035414	8340,- 348,-	035391
	madlo R	Kč €	5870,- 245,-	035360	7000,- 292,-	035421	8340,- 348,-	035407
pro tl. dveří 52 - 60 mm	madlo L	Kč €	6020,- 251,-	035438	7160,- 299,-	035490	8490,- 354,-	035476
	madlo R	Kč €	6020,- 251,-	035445	7160,- 299,-	035506	8490,- 354,-	035483
pro tl. dveří 61 - 68 mm	madlo L	Kč €	6150,- 257,-	035513	7300,- 305,-	035575	8630,- 360,-	035551
	madlo R	Kč €	6150,- 257,-	035520	7300,- 305,-	035582	8630,- 360,-	035568
pro tl. dveří 69 - 126 mm	madlo L	Kč €	6750,- 282,-	035599	7890,- 329,-	035650	9220,- 385,-	035636
	madlo R	Kč €	6750,- 282,-	035605	7890,- 329,-	035667	9220,- 385,-	035643

U madel pro tl. dveří 69 mm a více je třeba specifikovat přesnou tloušťku dveří. Integrovaná bezpečnostní rozeta má průměr 54 mm. Černá nerezová madla se dodávají v novém hrubém povrchu s označením K-industrial.

			NRz		TiN-C		K-industrial	
			cena	EAN	cena	EAN	cena	EAN
pro tl. dveří 38 - 45 mm	madlo L	Kč €	8640,- 360,-	035674	10110,- 422,-	035711	11440,- 477,-	035698
	madlo R	Kč €	8640,- 360,-	035681	10110,- 422,-	035728	11440,- 477,-	035704
pro tl. dveří 46 - 52 mm	madlo L	Kč €	8790,- 367,-	035735	10260,- 428,-	035773	11590,- 483,-	035759
	madlo R	Kč €	8790,- 367,-	035742	10260,- 428,-	035780	11590,- 483,-	035766
pro tl. dveří 52 - 60 mm	madlo L	Kč €	8940,- 373,-	035797	10400,- 434,-	035834	11730,- 489,-	035810
	madlo R	Kč €	8940,- 373,-	035803	10400,- 434,-	035841	11730,- 489,-	035827
pro tl. dveří 61 - 68 mm	madlo L	Kč €	9080,- 379,-	035858	10540,- 440,-	035896	11880,- 495,-	035872
	madlo R	Kč €	9080,- 379,-	035865	10540,- 440,-	035902	11880,- 495,-	035889
pro tl. dveří 69 - 126 mm	madlo L	Kč €	9230,- 385,-	035919	10700,- 446,-	035957	12020,- 501,-	035933
	madlo R	Kč €	9230,- 385,-	035926	10700,- 446,-	035964	12020,- 501,-	035940
madlo oboustranné	madlo L	Kč €	17280,- 720,-	035971	20210,- 843,-	036015	21530,- 898,-	035995
	madlo R	Kč €	17280,- 720,-	035988	20210,- 843,-	036022	21530,- 898,-	036008

Lze použít pro různé typy dveří s osazeným zámkem s otvory pro prošroubování rozety.



U oboustranného madla je třeba určit orientaci madla R nebo L podle vnějšího Bezpečnostního madla.

U madel pro tl. dveří 69 mm a více je třeba specifikovat přesnou tloušťku dveří. Integrovaná bezpečnostní rozeta má průměr 54 mm. Montážní materiál je nutno specifikovat podle materiálu dveří - viz. tabulka montážního materiálu str. 205. Černá nerezová madla se dodávají v novém hrubém povrchu s označením K-industrial.

			NRz		TiN-C		K-industrial	
			cena	EAN	cena	EAN	cena	EAN
pro tl. dveří 38 - 45 mm	madlo L	Kč €	8640,- 360,-	036039	10110,- 422,-	036077	12770,- 533,-	036053
	madlo R	Kč €	8640,- 360,-	036046	10110,- 422,-	036084	12770,- 533,-	036060
pro tl. dveří 46 - 52 mm	madlo L	Kč €	8790,- 367,-	036091	10260,- 428,-	036138	12920,- 539,-	036114
	madlo R	Kč €	8790,- 367,-	036107	10260,- 428,-	036145	12920,- 539,-	036121
pro tl. dveří 52 - 60 mm	madlo L	Kč €	8940,- 373,-	036152	10400,- 434,-	036190	13050,- 544,-	036176
	madlo R	Kč €	8940,- 373,-	036169	10400,- 434,-	036206	13050,- 544,-	036183
pro tl. dveří 61 - 68 mm	madlo L	Kč €	9080,- 379,-	036213	10540,- 440,-	036251	13210,- 551,-	036237
	madlo R	Kč €	9080,- 379,-	036220	10540,- 440,-	036268	13210,- 551,-	036244
pro tl. dveří 69 - 126 mm	madlo L	Kč €	9230,- 385,-	036275	10700,- 446,-	036312	13360,- 557,-	036299
	madlo R	Kč €	9230,- 385,-	036282	10700,- 446,-	036329	13360,- 557,-	036305
madlo oboustranné	madlo L	Kč €	17280,- 720,-	036336	20210,- 843,-	036374	22860,- 953,-	036350
	madlo R	Kč €	17280,- 720,-	036343	20210,- 843,-	036381	22860,- 953,-	036367

U oboustranného madla je třeba určit orientaci madla R nebo L podle vnějšího Bezpečnostního madla.

U madel pro tl. dveří 69 mm a více je třeba specifikovat přesnou tloušťku dveří. Integrovaná ochranná rozeta nemá šrouby pro prošroubování rozety skrz zámeč a plní základní bezpečnost. Použití ochranného madla pro hliníkové dveře. Ochranné madlo nemá certifikát NBU. Montážní materiál je nutno specifikovat podle materiálu dveří - viz. tabulka montážního materiálu str. 205.

Ochranné madlo Entero je možné montovat jako oboustranné (pár madel). Černá nerezová madla se dodávají v novém hrubém povrchu s označením K-industrial.



K černý mat

**Bezpečnostní madlo Entero 1000 mm**

11570,- Kč  
483,- EUR



NRz nerez - broušeno

materiál: nerezová ocel  
Kč povrch: NRz nerez - broušeno EUR

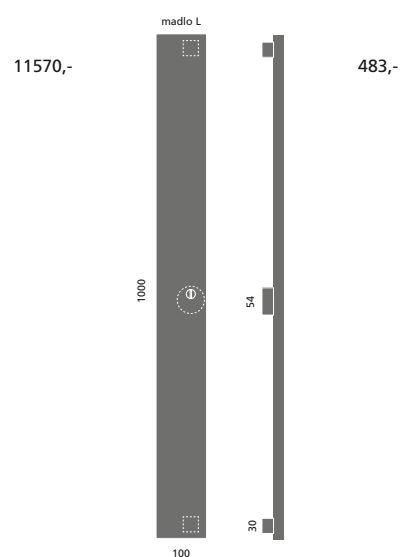

**Bezpečnostní madlo Entero 1000 mm s přidavnou rozetou**

13030,- Kč  
543,- EUR

materiál: nerezová ocel  
Kč povrch: NRz nerez - broušeno EUR

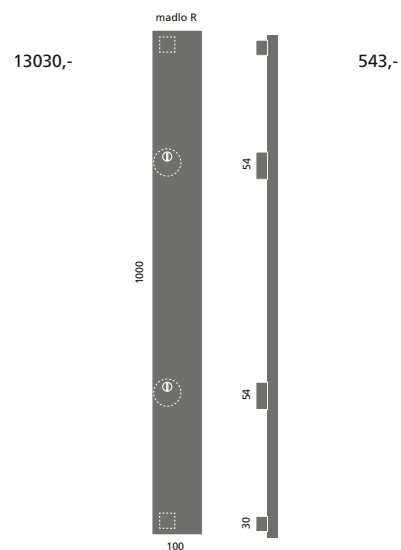

**Jednostranné kliky**



DESIGN 2006 [88 – 91]



DESIGN 2009 [92 – 99]



DESIGN 2011 [100 – 103]



DESIGN 2013 [106 – 111]



Kování pro hliníkové dveře [274 – 285]



Kování pro hliníkové dveře s orientací rozety naležato

			NRz		TiN-C		K-industrial	
			cena	EAN	cena	EAN	cena	EAN
pro tl. dveří 38 - 45 mm	madlo L	Kč €	11570,- 483,-	036398	13030,- 543,-	036435	14360,- 599,-	036411
	madlo R	Kč €	11570,- 483,-	036404	13030,- 543,-	036442	14360,- 599,-	036428
pro tl. dveří 46 - 52 mm	madlo L	Kč €	11710,- 488,-	036459	13180,- 550,-	036497	14510,- 605,-	036473
	madlo R	Kč €	11710,- 488,-	036466	13180,- 550,-	036503	14510,- 605,-	036480
pro tl. dveří 52 - 60 mm	madlo L	Kč €	11870,- 495,-	036510	13330,- 556,-	036558	14670,- 612,-	036534
	madlo R	Kč €	11870,- 495,-	036527	13330,- 556,-	036565	14670,- 612,-	036541
pro tl. dveří 61 - 68 mm	madlo L	Kč €	12010,- 501,-	036572	13470,- 562,-	036619	14800,- 617,-	036596
	madlo R	Kč €	12010,- 501,-	036589	13470,- 562,-	036626	14800,- 617,-	036602
pro tl. dveří 69 - 126 mm	madlo L	Kč €	12590,- 525,-	036633	14060,- 586,-	036671	15390,- 642,-	036657
	madlo R	Kč €	12590,- 525,-	036640	14060,- 586,-	036688	15390,- 642,-	036664
madlo oboustranné	madlo L	Kč €	23130,- 964,-	036695	26060,- 1086,-	036732	27380,- 1141,-	036718
	madlo R	Kč €	23130,- 964,-	036701	26060,- 1086,-	036749	27380,- 1141,-	036725

Lze použít pro různé typy dveří s osazeným zámkem s otvory pro prošroubování rozety.



U madel pro tl. dveří 69 mm a více je třeba specifikovat přesnou tloušťku dveří. Integrovaná bezpečnostní rozeta má průměr 54 mm. Individuálně lze dodávat i jiné rozměry madel do délky 3000 mm. Montážní materiál je nutno specifikovat podle materiálu dveří - viz. tabulka montážního materiálu. Černá nerezová madla se dodávají v novém hrubém povrchu s označením K-industrial.

			NRz		TiN-C		K-industrial	
			cena	EAN	cena	EAN	cena	EAN
pro tl. dveří 38 - 45 mm	madlo L	Kč €	13030,- 543,-	036756	14500,- 605,-	036794	15830,- 660,-	036770
	madlo R	Kč €	13030,- 543,-	036763	14500,- 605,-	036800	15830,- 660,-	036787
pro tl. dveří 46 - 52 mm	madlo L	Kč €	13180,- 550,-	036817	14630,- 610,-	036855	15960,- 665,-	036831
	madlo R	Kč €	13180,- 550,-	036824	14630,- 610,-	036862	15960,- 665,-	036848
pro tl. dveří 52 - 60 mm	madlo L	Kč €	13330,- 556,-	036879	14790,- 617,-	036916	16120,- 672,-	036893
	madlo R	Kč €	13330,- 556,-	036886	14790,- 617,-	036923	16120,- 672,-	036909
pro tl. dveří 61 - 68 mm	madlo L	Kč €	13470,- 562,-	036930	14930,- 623,-	036978	16270,- 678,-	036954
	madlo R	Kč €	13470,- 562,-	036947	14930,- 623,-	036985	16270,- 678,-	036961
pro tl. dveří 69 - 126 mm	madlo L	Kč €	14060,- 586,-	036992	15520,- 647,-	037036	16850,- 703,-	037012
	madlo R	Kč €	14060,- 586,-	037005	15520,- 647,-	037043	16850,- 703,-	037029
madlo oboustranné	madlo L	Kč €	26060,- 1000,-	037050	28980,- 1208,-	037098	30300,- 1263,-	037074
	madlo R	Kč €	26060,- 1000,-	037067	28980,- 1208,-	037104	30300,- 1263,-	037081

Lze použít pro různé typy dveří s osazeným zámkem s otvory pro prošroubování rozety.



Montážní materiál pro madla	cena sada	EAN
jednostranné do slepé díry - plast	Kč € 390,- 17,-	030204
jednostranné do slepé díry - hliník	Kč € 390,- 17,-	030211
jednostranné do slepé díry - dřevo	Kč € 390,- 17,-	030228
jednostranné s prošroubováním a záslepkou	Kč € 390,- 17,-	003024
oboustranné (pro Ochranná i Bezpeč. madla)	Kč € 390,- 17,-	003048

Bezpečnostní madlo s dvojicí bezpečnostních rozet pro max. zabezpečení. Umístění / rozteč rozet je možné specifikovat. Individuálně lze dodávat i jiné rozměry madel do délky 3000 mm. U madel pro tl. dveří 69 mm a více je třeba specifikovat přesnou tloušťku dveří. Integrovaná bezpečnostní rozeta má průměr 54 mm. Černá nerezová madla se dodávají v novém hrubém povrchu s označením K-industrial.

Montážní materiál je nutno specifikovat podle materiálu dveří - viz. tabulka montážního materiálu.

K bezpečnostnímu madlu Entero se z vnitřní strany dveří dodává rozetové kování M&T - jednostranná klika. Montážně lze využít dveřní kliky DESIGN 2006, 2009, 2011, 2013 a kování pro hliníkové dveře. Objednává se 1/2 páru a je třeba specifikovat orientaci kliky L nebo R. Nezbytný montážní komponent je rozpěrný čtyřhran viz. Příslušenství a komponenty str. 376. Rozpěrný čtyřhran a jednostranná klika nejsou součástí bezpečnostního madla Entero a objednávat se zvlášť. Cena jednostranné kliky je 1/2 páru.

Součástí dodávky bezpečnostního madla Entero je vnitřní cylindrická rozeta. Vnitřní cylindrická rozeta je volitelná ve více tvarových variantách podle designu kliky.

Variety rozety vnitřní kliky

rozeta DESIGN 2006, 2009



čtvercová 54x54 mm

rozeta DESIGN 2011



čtvercová Minimal 54x54 mm

rozeta DESIGN 2013



čtvercová Minimal 54x54 mm

obdélníková naležato (Al profily)



čtvercová Minimal 54x54 mm

obdélníková 33 mm (Al profily)



obdélníková šíře 33 mm

Variety vnitřní cylindrické rozety



Příbuzný sortiment

Madla a koule na skleněné  
a dřevěné dveře

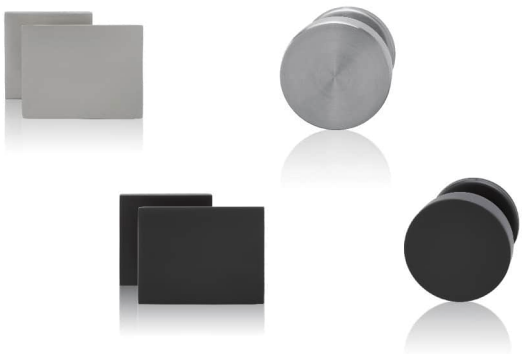

Madla dlouhá



## Bezpečnostní rozety

Bezpečnostní rozety M&T jsou konstrukčně navrženy a patentovány pro maximální bezpečnost, díky které plnohodnotně nahrazují štítové bezpečnostní kování. Předností je designová a barevnostní jednotnost s jakýmkoliv rozetovým kováním z produkce M&T. Jedinečností je konstrukční variabilita s možností montáže na dveře až do tloušťky 126 mm. Těmito parametry se nemůže pochlubit žádné bezpečnostní kování na trhu.

Materiál: **masivní mosaz**

Povrchy: **SNi, Cr, SNi-broušeno, TiN-C, TiN-B, TiN-K, Ms, Ms-L, zakázkově TiN-S, TiN-A**  
více info na [www.kliky-mt.cz/manufaktura/barvy-povrchy](http://www.kliky-mt.cz/manufaktura/barvy-povrchy)

Materiál: **nerezová ocel**

Povrchy: **NRz, TiN-K, K-industrial**

Ø 54 mm **TiN-K**



**ENTERO TiN-B**



**MINIMAL SNi**



Ø 54 mm **NRz**



**ENTERO NRz**



k řadě kování DESIGN 2000

k řadě kování DESIGN 2004,  
DESIGN 2006, 2009, 2011

k řadě kování Minimal/Maximal

k řadě kování Nerezové kování,  
DESIGN 2012 ploché rozety,  
Zapuštěné rozety

možnosti kombinací



MATY



madlo ENTRY



ENTERO



madlo MINIMAL



koule MATY



madlo ENTERO



FABI



TORO



MIMOLIMIT



MAYA

konstrukční varianty, materiálové provedení

- rozeta z vnitřní strany dveří vždy designově shodná s rozetou kliky
- koule a madla vždy v designu podle kliky z vnitřní strany dveří
- možno i kombinovat s jakýmkoliv typem dlouhého madla
- patentovaný konstrukční systém
- vrtání s PROFI šablonou M&T pomocí univerzálního vrtáku 6,4/12 mm
- velmi rychlá a snadná montáž
- montáž pro tloušťky dveří 38 – 126 mm
- záruka 3 roky, NRz 5 let, K-industrial 5 let, titany 15 let

roky **3 garance** let **5 garance** let **15 garance**

vrtání PROFI  
šablonou M&T



Ochranné známky – registrované značky



**ENTERO®**  
**MINIMAL®**

Patent



konstrukce Bezpečnostní rozety

Pro maximální bezpečnost doporučujeme kombinovat bezpečnostní rozety M&T s cylindrickými vložkami EVVA.

Certifikace: bezpečnostní certifikáty státem akreditované zkušebny Trezor Test a NBÚ (Národní bezpečnostní úřad).

Certifikáty lze stáhnout na [www.kliky-mt.cz/katalog/bezpecnostni-rozety/](http://www.kliky-mt.cz/katalog/bezpecnostni-rozety/) u jednotlivých produktů.



SNI matný nikel

### Bezpečnostní rozeta Ø 54 mm

2190,- Kč  
92,- EUR



Ms-L mosaz leštěno



Cr lesklý chrom

KČ	materiál: zušlechťená ocel povrch: SNI matný nikel	EUR
	pro tl. dveří	
2190,-	38 - 45 mm	92,-
2350,-	46 - 52 mm	98,-
2490,-	53 - 60 mm	104,-
2640,-	61 - 68 mm	110,-
2780,-	69 - 76 mm	116,-
2930,-	77 - 83 mm	123,-
3220,-	84 - 90 mm	135,-
3510,-	91 - 97 mm	147,-
3810,-	98 - 104 mm	159,-
4100,-	105 - 112 mm	171,-
4380,-	113 - 118 mm	183,-
4690,-	119 - 126 mm	196,-



TiN-C titan chrom mat

### Bezpečnostní rozeta Ø 54 mm NRz

2050,- Kč  
86,- EUR



TiN-K titan černý mat



NRz nerez - broušeno

KČ	materiál: nerezová ocel kalitelná povrch: NRz nerez - broušeno	EUR
	pro tl. dveří	
2050,-	38 - 45 mm	86,-
2190,-	46 - 52 mm	92,-
2350,-	53 - 60 mm	98,-
2490,-	61 - 68 mm	104,-
2640,-	69 - 76 mm	110,-
2780,-	77 - 83 mm	116,-
3070,-	84 - 90 mm	128,-
3380,-	91 - 97 mm	141,-
3660,-	98 - 104 mm	153,-
3950,-	105 - 112 mm	165,-
4250,-	113 - 118 mm	178,-
4540,-	119 - 126 mm	190,-



	SNI		NRz		Cr		Ms		Ms-L		TiN-C		TiN-K		K-industrial		
	cena ks	EAN	cena ks	EAN	cena ks	EAN	cena ks	EAN	cena ks	EAN	cena ks	EAN	cena ks	EAN	cena ks	EAN	
pro tl. dveří																	
38 - 45 mm	Kč €	2190,- 92,-	69084	2050,- 86,-	019957	2350,- 98,-	69145	2350,- 98,-	058574	2350,- 98,-	058697	2930,- 123,-	69268	2930,- 123,-	69329	2930,- 123,-	033458
46 - 52 mm	Kč €	2350,- 98,-	69091	2190,- 92,-	019964	2490,- 104,-	69152	2490,- 104,-	058581	2490,- 104,-	058703	3070,- 128,-	69275	3070,- 128,-	69336	3070,- 128,-	033465
53 - 60 mm	Kč €	2490,- 104,-	69107	2350,- 98,-	019971	2640,- 110,-	69169	2640,- 110,-	058598	2640,- 110,-	058710	3220,- 135,-	69282	3220,- 135,-	69343	3220,- 135,-	033472
61 - 68 mm	Kč €	2640,- 110,-	69114	2490,- 104,-	019988	2780,- 116,-	69176	2780,- 116,-	058604	2780,- 116,-	058727	3380,- 141,-	69299	3380,- 141,-	69350	3380,- 141,-	033489
69 - 76 mm	Kč €	2780,- 116,-	69121	2640,- 110,-	019995	2930,- 123,-	69183	2930,- 123,-	058611	2930,- 123,-	058734	3510,- 147,-	69305	3510,- 147,-	69367	3510,- 147,-	033496
77 - 83 mm	Kč €	2930,- 123,-	69138	2780,- 116,-	020007	3070,- 128,-	69190	3070,- 128,-	058628	3070,- 128,-	058741	3660,- 153,-	69312	3660,- 153,-	69374	3660,- 153,-	033502
84 - 90 mm	Kč €	3220,- 135,-	019896	3070,- 128,-	020014	3380,- 141,-	020076	3380,- 141,-	058635	3380,- 141,-	058758	3950,- 165,-	020199	3950,- 165,-	020250	3950,- 165,-	033519
91 - 97 mm	Kč €	3510,- 147,-	019902	3380,- 141,-	020021	3660,- 153,-	020083	3660,- 153,-	058642	3660,- 153,-	058765	4250,- 178,-	020205	4250,- 178,-	020267	4250,- 178,-	033526
98 - 104 mm	Kč €	3810,- 159,-	019919	3660,- 153,-	020038	3950,- 165,-	020090	3950,- 165,-	058659	3950,- 165,-	058772	4540,- 190,-	020212	4540,- 190,-	020274	4540,- 190,-	033533
105 - 112 mm	Kč €	4100,- 171,-	019926	3950,- 165,-	020045	4250,- 178,-	020106	4250,- 178,-	058666	4250,- 178,-	058789	4830,- 202,-	020229	4830,- 202,-	020281	4830,- 202,-	033540
113 - 118 mm	Kč €	4380,- 183,-	019933	4250,- 178,-	020052	4540,- 190,-	020113	4540,- 190,-	058673	4540,- 190,-	058796	5120,- 214,-	020236	5120,- 214,-	020298	5120,- 214,-	033557
119 - 126 mm	Kč €	4690,- 196,-	019940	4540,- 190,-	020069	4830,- 202,-	020120	4830,- 202,-	058680	4830,- 202,-	058802	5410,- 226,-	020243	5410,- 226,-	020304	5410,- 226,-	033564

U kombinace kliky / kliky a koule / kliky k Bezpečnostní rozetě Ø 54 mm jsou standardně použity kovové podrozety odolné proti rozlomení. Objednávkové EAN kliky / kliky a koule / kliky viz. Design 2000 str. 78 - 83, EAN pro Nerezové kliky str. 32 - 35.

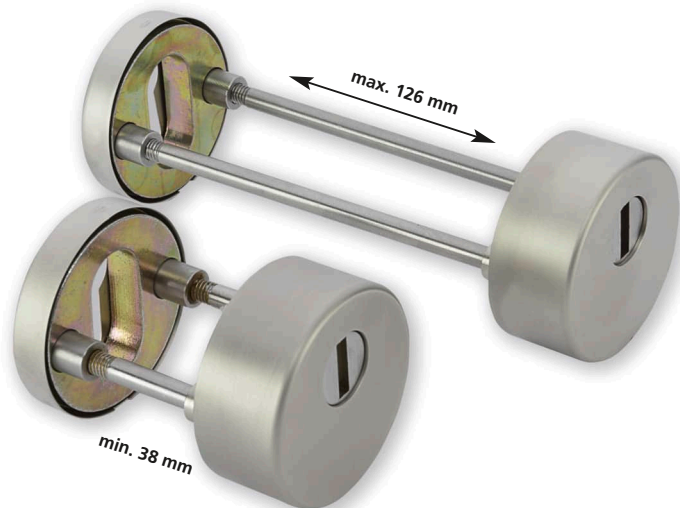

Doporučený výstup cylindrické vložky z vnitřní strany dveří 11 - 12 mm.

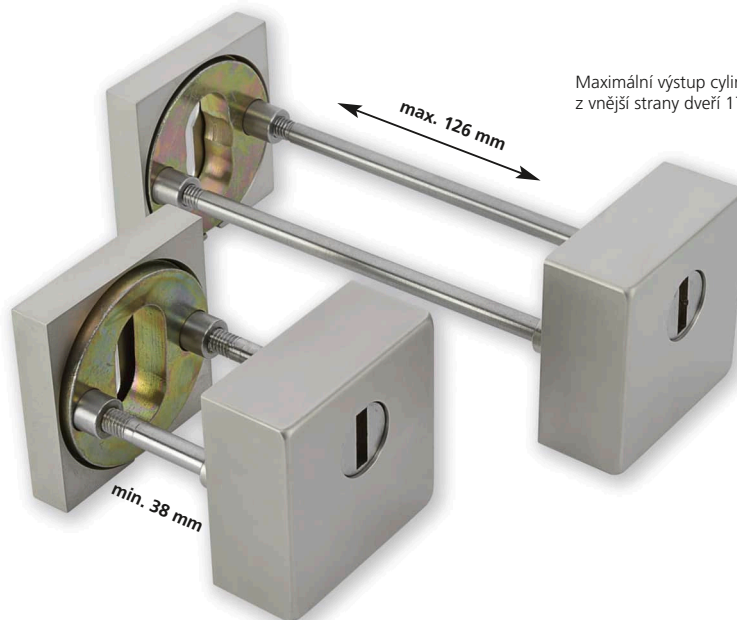

Maximální výstup cylindrické vložky z vnější strany dveří 17,5 mm.



SNi matný nikel



TiN-K titan černý mat



Cr lesklý chrom



TiN-B titan braun mat



TiN-S titan bronz mat



SNi - broušeno matný nikel broušený



TiN-C titan chrom mat



TiN-A titan mosaz mat



NRz nerez - broušeno

### Bezpečnostní rozeta Entero

3660,- Kč  
153,- EUR

Kč	materiál: zušlechťená ocel povrch: SNi matný nikel	EUR
	pro tl. dveří	
3660,-	38 - 45 mm	153,-
3810,-	46 - 52 mm	159,-
3950,-	53 - 60 mm	165,-
4250,-	61 - 68 mm	178,-
4380,-	69 - 76 mm	183,-
4540,-	77 - 83 mm	190,-
4830,-	84 - 90 mm	202,-
5120,-	91 - 97 mm	214,-
5410,-	98 - 104 mm	226,-
5710,-	105 - 112 mm	238,-
6000,-	113 - 118 mm	250,-
6300,-	119 - 126 mm	263,-

### Bezpečnostní rozeta Entero NRz

3380,- Kč  
141,- EUR

Kč	materiál: nerezová ocel kalitelná povrch: NRz nerez - broušeno	EUR
	pro tl. dveří	
3380,-	38 - 45 mm	141,-
3510,-	46 - 52 mm	147,-
3660,-	53 - 60 mm	153,-
3810,-	61 - 68 mm	159,-
3950,-	69 - 76 mm	165,-
4250,-	77 - 83 mm	178,-
4540,-	84 - 90 mm	190,-
4830,-	91 - 97 mm	202,-
5120,-	98 - 104 mm	214,-
5410,-	105 - 112 mm	226,-
5710,-	113 - 118 mm	238,-
6000,-	119 - 126 mm	250,-

	SNI		SNI - broušeno		NRz		Cr		K-industrial		
	cena / ks	EAN	cena / ks	EAN	cena / ks	EAN	cena / ks	EAN	cena / ks	EAN	
pro tl. dveří											
38 - 45 mm	Kč €	3660,- 153,-	021813	3660,- 153,-	68780	3380,- 141,-	020434	3810,- 159,-	68841	4380,- 183,-	033571
46 - 52 mm	Kč €	3810,- 159,-	021820	3810,- 159,-	68797	3510,- 147,-	020441	3950,- 165,-	68858	4540,- 190,-	033588
53 - 60 mm	Kč €	3950,- 165,-	021837	3950,- 165,-	68803	3660,- 153,-	020458	4100,- 171,-	68865	4690,- 196,-	033595
61 - 68 mm	Kč €	4250,- 178,-	021844	4250,- 178,-	68810	3810,- 159,-	020465	4380,- 183,-	68872	4980,- 208,-	033601
69 - 76 mm	Kč €	4380,- 183,-	021851	4380,- 183,-	68827	3950,- 165,-	020472	4540,- 190,-	68889	5120,- 214,-	033618
77 - 83 mm	Kč €	4540,- 190,-	021868	4540,- 190,-	68834	4250,- 178,-	020489	4690,- 196,-	68896	5270,- 220,-	033625
84 - 90 mm	Kč €	4830,- 202,-	021875	4830,- 202,-	020373	4540,- 190,-	020496	4980,- 208,-	020557	5570,- 233,-	033632
91 - 97 mm	Kč €	5120,- 214,-	021882	5120,- 214,-	020380	4830,- 202,-	020502	5270,- 220,-	020564	5850,- 244,-	033649
98 - 104 mm	Kč €	5410,- 226,-	021899	5410,- 226,-	020397	5120,- 214,-	020519	5570,- 233,-	020571	6140,- 256,-	033656
105 - 112 mm	Kč €	5710,- 238,-	021905	5710,- 238,-	020403	5410,- 226,-	020526	5850,- 244,-	020588	6430,- 268,-	033663
113 - 118 mm	Kč €	6000,- 250,-	021912	6000,- 250,-	020410	5710,- 238,-	020533	6140,- 256,-	020595	6740,- 281,-	033670
119 - 126 mm	Kč €	6300,- 263,-	021929	6300,- 263,-	020427	6000,- 250,-	020540	6430,- 268,-	020601	7030,- 293,-	033687

	TiN-S		TiN-C		TiN-B		TiN-K		TiN-A		
	cena / ks	EAN	cena / ks	EAN	cena / ks	EAN	cena / ks	EAN	cena / ks	EAN	
pro tl. dveří											
38 - 45 mm	Kč €	4380,- 183,-	68902	4380,- 183,-	68964	4380,- 183,-	65505	4380,- 183,-	69022	4380,- 183,-	73555
46 - 52 mm	Kč €	4540,- 190,-	68919	4540,- 190,-	68971	4540,- 190,-	65512	4540,- 190,-	69039	4540,- 190,-	73562
53 - 60 mm	Kč €	4690,- 196,-	68926	4690,- 196,-	68988	4690,- 196,-	65529	4690,- 196,-	69046	4690,- 196,-	73579
61 - 68 mm	Kč €	4980,- 208,-	68933	4980,- 208,-	68995	4980,- 208,-	65536	4980,- 208,-	69053	4980,- 208,-	73586
69 - 76 mm	Kč €	5120,- 214,-	68940	5120,- 214,-	69008	5120,- 214,-	65543	5120,- 214,-	69060	5120,- 214,-	73593
77 - 83 mm	Kč €	5270,- 220,-	68957	5270,- 220,-	69015	5270,- 220,-	65550	5270,- 220,-	69077	5270,- 220,-	73609
84 - 90 mm	Kč €	5570,- 233,-	020618	5570,- 233,-	020731	5570,- 233,-	020793	5570,- 233,-	020854	5570,- 233,-	020915
91 - 97 mm	Kč €	5850,- 244,-	020625	5850,- 244,-	020748	5850,- 244,-	020809	5850,- 244,-	020861	5850,- 244,-	020922
98 - 104 mm	Kč €	6140,- 256,-	020632	6140,- 256,-	020755	6140,- 256,-	020816	6140,- 256,-	020878	6140,- 256,-	020939
105 - 112 mm	Kč €	6430,- 268,-	020649	6430,- 268,-	020762	6430,- 268,-	020823	6430,- 268,-	020885	6430,- 268,-	020946
113 - 118 mm	Kč €	6740,- 281,-	020656	6740,- 281,-	020779	6740,- 281,-	020830	6740,- 281,-	020892	6740,- 281,-	020953
119 - 126 mm	Kč €	7030,- 293,-	020663	7030,- 293,-	020786	7030,- 293,-	020847	7030,- 293,-	020908	7030,- 293,-	020960

U kombinace klika / klika a madlo / klika k Bezpečnostní rozetě Entero jsou standardně použity kovové podrozety odolné proti rozlomení u klik Design 2004 a Nerezových klik. Objednávkové EAN klika / klika a madlo / klika viz. Design 2004 str. 84 - 87, Design 2006 str. 90 - 91, Design 2009 str. 94 - 97, Design 2011 str. 102 - 103. EAN pro Nerezové kliky str. 36 - 37.



SNi matný nikel



TiN-K titan černý mat



TiN-B titan braun mat

### Bezpečnostní rozeta Minimal

4380,- Kč  
183,- EUR

Kč	materiál: zušlechťená ocel povrch: SNi matný nikel	EUR
	pro tl. dveří	
4380,-	38 - 45 mm	183,-
4540,-	46 - 52 mm	190,-
4690,-	53 - 60 mm	196,-
4980,-	61 - 68 mm	208,-
5120,-	69 - 76 mm	214,-
5270,-	77 - 83 mm	220,-
5570,-	84 - 90 mm	233,-
5850,-	91 - 97 mm	244,-
6140,-	98 - 104 mm	256,-
6430,-	105 - 112 mm	268,-
6740,-	113 - 118 mm	281,-
7030,-	119 - 126 mm	293,-

	SNi		SNi - broušeno		Cr		TiN-C		TiN-B		TiN-K		TiN-A		K-industrial	
	cena	EAN	cena	EAN	cena	EAN	cena	EAN	cena	EAN	cena	EAN	cena	EAN	cena	EAN
	ks		ks		ks		ks		ks		ks		ks		ks	
pro tl. dveří																
38 - 45 mm	Kč €	4380,- 020977	183,-	4380,- 021097	183,-	4540,- 021219	190,-	5120,- 021332	214,-	5120,- 021455	214,-	5120,- 021578	214,-	5120,- 021691	214,-	142655
46 - 52 mm	Kč €	4540,- 020984	190,-	4540,- 021103	190,-	4690,- 021226	196,-	5270,- 021349	220,-	5270,- 021462	220,-	5270,- 021585	220,-	5270,- 021707	220,-	142662
53 - 60 mm	Kč €	4690,- 020991	196,-	4690,- 021110	196,-	4830,- 021233	202,-	5410,- 021356	226,-	5410,- 021479	226,-	5410,- 021592	226,-	5410,- 021714	226,-	142679
61 - 68 mm	Kč €	4980,- 021004	208,-	4980,- 021127	208,-	5120,- 021240	214,-	5710,- 021363	238,-	5710,- 021486	238,-	5710,- 021608	238,-	5710,- 021721	238,-	142686
69 - 76 mm	Kč €	5120,- 021011	214,-	5120,- 021134	214,-	5270,- 021257	220,-	5850,- 021370	244,-	5850,- 021493	244,-	5850,- 021615	244,-	5850,- 021738	244,-	142693
77 - 83 mm	Kč €	5270,- 021028	220,-	5270,- 021141	220,-	5410,- 021264	226,-	6000,- 021387	250,-	6000,- 021509	250,-	6000,- 021622	250,-	6000,- 021745	250,-	142709
84 - 90 mm	Kč €	5570,- 021035	233,-	5570,- 021158	233,-	5710,- 021271	238,-	6300,- 021394	263,-	6300,- 021516	263,-	6300,- 021639	263,-	6300,- 021752	263,-	142716
91 - 97 mm	Kč €	5850,- 021042	244,-	5850,- 021165	244,-	6000,- 021288	250,-	6580,- 021400	275,-	6580,- 021523	275,-	6580,- 021646	275,-	6580,- 021769	275,-	142723
98 - 104 mm	Kč €	6140,- 021059	256,-	6140,- 021172	256,-	6300,- 021295	263,-	6870,- 021417	287,-	6870,- 021530	287,-	6870,- 021653	287,-	6870,- 021776	287,-	142730
105 - 112 mm	Kč €	6430,- 021066	268,-	6430,- 021189	268,-	6580,- 021301	275,-	7170,- 021424	299,-	7170,- 021547	299,-	7170,- 021660	299,-	7170,- 021783	299,-	142747
113 - 118 mm	Kč €	6740,- 021073	281,-	6740,- 021196	281,-	6870,- 021318	287,-	7460,- 021431	311,-	7460,- 021554	311,-	7460,- 021677	311,-	7460,- 021790	311,-	142754
119 - 126 mm	Kč €	7030,- 021080	293,-	7030,- 021202	293,-	7170,- 021325	299,-	7760,- 021448	324,-	7760,- 021561	324,-	7760,- 021684	324,-	7760,- 021806	324,-	142761

U kombinace klika / klika a madlo / klika k Bezpečnostní rozetě Minimal se standardně dodává klika Minimal. Objednávkové EAN klika / klika a madlo / klika viz. Design 2013 str. 106 - 107.





Příbuzný sortiment

Bezpečnostní rozety



Kování pro hliníkové a ocelové dveře,  
kování na branky



Příslušenství a komponenty  
Rozpěrný čtyřhran

**Jednostranné kliky**

DESIGN 2006  
DESIGN 2009  
DESIGN 2011  
DESIGN 2013

## Madla dlouhá

Dlouhá madla M&T jsou vyráběna v několika materiálových a designových řadách splňujících náročné požadavky zákazníků na tvar, použití a rozměry. Řada nerezových madel je univerzální pro široký okruh použití ve variantě rovné nebo vyosené s možností zakázkové výroby v individuálních délkách. Madla Minimal / Maximal vynikají svým designem a velkou předností je možnost kombinací ve všech barevných odstínech povrchových úprav M&T. Jedinečností je konstrukční variabilita u madel Mimolimit s použitím různých masivních dřevin, kde je standardně možnost dodání madel až do délky 2440 mm. Mimořádná v nabídce jsou madla Yes! s unikátním integrovaným WC zamykáním.

Materiál: **masivní mosaz**   
 Povrchy: **SNi, Cr, SNi-broušeno, TiN-C, TiN-B, TiN-K, Ms, Ms-L, zakázkově TiN-A**  
 více info na [www.kliky-mt.cz/manufaktura/barvy-povrchy](http://www.kliky-mt.cz/manufaktura/barvy-povrchy)

Materiál: **nerezová ocel**  
 Povrchy: **NRz, K-industrial, TiN-C, TiN-A**

madla  
 Minimal/Maximal  
**TiN-K** titan černý mat

madla Mimolimit  
**SNi** matný nikl  
 + masivní dřevo teak

madla Yes!  
**TiN-K** titan černý mat

madla řady Entero, Lusy, Deny,  
 Andy, Tyčinka  
**NRz** nerez - broušeno



str. 236 - 245

### konstrukční varianty, materiálové provedení

- madla jsou vyráběna jako jednostranná, nebo oboustranná
- montážně pro skleněné, nebo dřevěné dveře (včetně plastových, ocelových, hliníkových)
- montážní materiál není součástí madel, je třeba specifikovat podle typu dveří a varianty použití
- madla Mimolimit dodáváme v délkách od 340 mm do 2440 mm
- nerezová madla s možností individuální délky
- černá nerezová madla se dodávají v novém hrubém povrchu s označením K-industrial, do délky max. 2500 mm
- vyosená nerezová madla jsou vyrobena s vyosením pod úhlem 45°
- nerezová madla lze individuálně podle charakteru zakázky povlakovat titanovými povrchy do délky max. 1000 mm
- k jednostranným madlům lze objednat jednostranné kliky (1/2 páru) s rozpěrným čtyřhranem - viz. Příslušenství a komponenty
- výkresy vrtání otvorů pro montáž madel na [www.kliky-mt.cz/montaze-kovani](http://www.kliky-mt.cz/montaze-kovani)
- záruka 3 roky, NRz 5 let, K-industrial 5 let, titany 15 let

### Ochranné známky – registrované značky



**ENTERO®**  
**MINIMAL®**  
**MAXIMAL®**  
**MIMOLIMIT®**

### Chráněné průmyslové vzory madel



**MIMOLIMIT**  
**MINIMAL**  
**MAXIMAL**  
**YES!**

roky **3 garance** let **5 garance** let **15 garance**



TiN-K titan černý mat



TiN-B titan braun mat



SNI matný nikl  
výplň dřevo teak



TiN-K titan černý mat + jilm



TiN-B titan braun mat  
+ bělený dub



SNI matný nikl + teak

**Madlo dlouhé Minimal**  
rozteč 250 / délka 297 mm

11560,- Kč  
482,- EUR

**Madlo dlouhé Maximal**  
rozteč 250 / délka 297 mm

11960,- Kč  
6000,- EUR

**Výplň madla Maximal**

590,- Kč  
25,- EUR

**Madlo Mimolimit**

4310,- Kč  
180,- EUR

**Dřevěná část madla**

1180,- Kč  
50,- EUR

materiál: masivní mosaz  
povrch: SNI matný nikl

**KČ** **EUR**

11560,- 482,-

5800,- 242,-

11960,- 499,-

6000,- 250,-

materiál: masivní mosaz  
povrch: SNI matný nikl  
broušeno

**KČ** **EUR**

4310,- 180,-

5150,- 215,-

7560,- 315,-

8550,- 357,-

11260,- 470,-

14140,- 590,-

materiál: masivní dřevo  
povrch: olejováno

**KČ** **EUR**

1180,- 50,-

1740,- 73,-

2330,- 98,-

2580,- 108,-

3100,- 130,-

3490,- 146,-





		Sni		Sni - broušeno		Cr		Ms		TiN-C		TiN-B		TiN-K	
		cena	EAN	cena	EAN	cena	EAN	cena	EAN	cena	EAN	cena	EAN	cena	EAN
oboustranné	Kč €	pár 11560,- 482,-	002706	pár 11890,- 496,-	002713	pár 12260,- 511,-	002720	pár 12260,- 511,-	058819	pár 14480,- 604,-	002737	pár 14480,- 604,-	002744	pár 14480,- 604,-	002751
jednostranné	Kč €	ks 5800,- 242,-	002775	ks 5950,- 248,-	002782	ks 6140,- 256,-	002799	ks 6140,- 256,-	058826	ks 7250,- 303,-	002805	ks 7250,- 303,-	002812	ks 7250,- 303,-	002829
oboustranné	Kč €	pár 11960,- 499,-	002843	pár 12300,- 513,-	002850	pár 12630,- 527,-	002867	pár 12630,- 527,-	058857	pár 14930,- 623,-	002874	pár 14930,- 623,-	002881	pár 14930,- 623,-	002898
jednostranné	Kč €	ks 6000,- 250,-	002911	ks 6160,- 257,-	002928	ks 6330,- 264,-	002935	ks 6330,- 264,-	058864	ks 7480,- 312,-	002942	ks 7480,- 312,-	002959	ks 7480,- 312,-	002966

		cena	EAN
		ks	
dřevo	Kč €	590,- 25,-	002980
kov	Kč €	590,- 25,-	002997
kůže	Kč €	700,- 30,-	003000
„sklo“	Kč €	700,- 30,-	003017
RAL barvy	Kč €	730,- 31,-	022520

Montážní materiál pro madla		cena	EAN
		sada	
jednostranné do slepé díry - plast	Kč €	390,- 17,-	030204
jednostranné do slepé díry - hliník	Kč €	390,- 17,-	030211
jednostranné do slepé díry - dřevo	Kč €	390,- 17,-	030228

Montážní materiál pro madla		cena	EAN
		sada	
jednostranné s prošroubováním a záslepkou	Kč €	390,- 17,-	003024
jednostranné na sklo s prošroubováním a záslepkou	Kč €	510,- 22,-	003031
oboustranné	Kč €	390,- 17,-	003048
oboustranné na sklo	Kč €	510,- 22,-	003055



rozteč / celk. délka		Sni - broušeno		Cr		Ms		TiN-C		TiN-K		TiN-B	
		cena	EAN	cena	EAN	cena	EAN	cena	EAN	cena	EAN	cena	EAN
		ks		ks		ks		ks		ks		ks	
300 / 340 mm	Kč €	4310,- 180,-	83301	4440,- 185,-	022209	4440,- 185,-	058895	5840,- 244,-	83349	6310,- 263,-	83363	6310,- 263,-	83387
600 / 640 mm	Kč €	5150,- 215,-	83318	5290,- 221,-	022216	5290,- 221,-	058901	6690,- 279,-	83356	7160,- 299,-	83370	7160,- 299,-	83394
900 / 940 mm	Kč €	7560,- 315,-	83974	7700,- 321,-	022223	7700,- 321,-	058918	9400,- 392,-	84018	9870,- 412,-	84056	9870,- 412,-	84094
1200 / 1240 mm	Kč €	8550,- 357,-	83981	8710,- 363,-	022230	8710,- 363,-	058925	10100,- 421,-	84025	10560,- 440,-	84063	10560,- 440,-	84100
1800 / 1840 mm	Kč €	11260,- 470,-	83998	11430,- 477,-	022247	11430,- 477,-	058932	13590,- 567,-	84032	14060,- 586,-	84070	14060,- 586,-	84117
2400 / 2440 mm	Kč €	14140,- 590,-	84001	14280,- 595,-	022254	14280,- 595,-	058949	17070,- 712,-	84049	17540,- 731,-	84087	17540,- 731,-	84124

pro rozteč		Teak		Jilm		Ořech		Dub		Bělený dub	
		cena	EAN	cena	EAN	cena	EAN	cena	EAN	cena	EAN
		ks		ks		ks		ks		ks	
300 mm	Kč €	1180,- 50,-	83400	970,- 41,-	83424	970,- 41,-	83448	970,- 41,-	83936	1080,- 45,-	83950
600 mm	Kč €	1740,- 73,-	83417	1450,- 61,-	83431	1450,- 61,-	83929	1450,- 61,-	83943	1600,- 67,-	83967
900 mm	Kč €	2330,- 98,-	84131	1930,- 81,-	84179	1930,- 81,-	84216	1930,- 81,-	84254	2140,- 90,-	84292
1200 mm	Kč €	2580,- 108,-	84148	2270,- 95,-	84186	2270,- 95,-	84223	2270,- 95,-	84261	2500,- 105,-	84308
1800 mm	Kč €	3100,- 130,-	84155	2580,- 108,-	84193	2580,- 108,-	84230	2580,- 108,-	84278	2840,- 119,-	84315
2400 mm	Kč €	3490,- 146,-	84162	2910,- 122,-	84209	2910,- 122,-	84247	2910,- 122,-	84285	3200,- 134,-	84322

Zakázkově lze rukojeť dodat v dalších dřevinách.

Ceny modelů jsou uvedeny bez montážního materiálu. Montážní materiál je nutno specifikovat podle materiálu dveří. Tabulka montážního materiálu na str. 221.

**Kč** materiál: nerezová ocel  
 povrch: NRz nerez - broušeno **EUR**

**Madlo Lusy Ø 30 mm**

3000,- Kč  
 125,- EUR

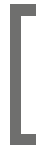
3000,-		125,-
3070,-		128,-
3510,-		147,-

**Madlo Deny Ø 30 mm**

2070,- Kč  
 87,- EUR

2070,-		87,-
2180,-		91,-
2640,-		110,-

**Madlo Andy Ø 30 mm**

3870,- Kč  
 162,- EUR

3870,-		162,-
4220,-		176,-

**Madlo Entero II □ 20/30 mm**

4350,- Kč  
 182,- EUR

4350,-		182,-
4810,-		201,-
5310,-		222,-

**Madlo Entero □ 20/30 mm**  
 úchopná část

4180,- Kč  
 175,- EUR

4180,-		175,-
4340,-		181,-
4800,-		200,-

**Madlo Tyčinka Ø 20 mm**

2870,- Kč  
 120,- EUR

2870,-		120,-
3220,-		135,-
3520,-		147,-
3920,-		164,-

NRz nerez - broušeno

K-industrial černý mat strukturovaný

		NRz		TiN-C		K-industrial		TiN-A	
		cena / ks	EAN	cena / ks	EAN	cena / ks	EAN	cena / ks	EAN
rozteč 230 mm	Kč €	3000,- 125,-	30602	4570,- 191,-	30695	5910,- 247,-	30725	4570,- 191,-	42759
rozteč 350 mm	Kč €	3070,- 128,-	30619	4660,- 195,-	30701	6000,- 250,-	30732	4660,- 195,-	42766
rozteč 650 mm	Kč €	3510,- 147,-	30626	5100,- 213,-	30718	6430,- 268,-	30749	5100,- 213,-	42773
rozteč 230 mm	Kč €	2070,- 87,-	30008	3640,- 152,-	30091	4980,- 208,-	30121	3640,- 152,-	42780
rozteč 350 mm	Kč €	2180,- 91,-	30015	3770,- 158,-	30107	5100,- 213,-	30138	3770,- 158,-	42797
rozteč 650 mm	Kč €	2640,- 110,-	30022	4240,- 177,-	30114	5570,- 233,-	30145	4240,- 177,-	42803
rozteč 350 mm / celková délka 500 mm	Kč €	3870,- 162,-	31005	5460,- 228,-	31036	6780,- 283,-	31043	5460,- 228,-	42827
rozteč 550 mm / celková délka 700 mm	Kč €	4220,- 176,-	72565	5820,- 243,-	72596	7150,- 298,-	72602	5820,- 243,-	72619
rozteč 230 mm / celková délka 380 mm	Kč €	4350,- 182,-	73371	6210,- 259,-	73463	7530,- 314,-	73494	6210,- 259,-	73524
rozteč 350 mm / celková délka 500 mm	Kč €	4810,- 201,-	73388	6680,- 279,-	73470	8010,- 334,-	73500	6680,- 279,-	73531
rozteč 650 mm / celková délka 800 mm	Kč €	5310,- 222,-	73395	7170,- 299,-	73487	8510,- 355,-	73517	7170,- 299,-	73548
rozteč 230 mm	Kč €	4180,- 175,-	73197	6050,- 253,-	73289	7390,- 308,-	73319	6050,- 253,-	73340
rozteč 350 mm	Kč €	4340,- 181,-	73203	6200,- 259,-	73296	7520,- 314,-	73326	6200,- 259,-	73357
rozteč 650 mm	Kč €	4800,- 200,-	73210	6660,- 278,-	73302	7990,- 333,-	73333	6660,- 278,-	73364
rozteč 300 mm / celková délka 400 mm	Kč €	2870,- 120,-	157277	4460,- 186,-	157314	5780,- 241,-	157352	4460,- 186,-	157390
rozteč 600 mm / celková délka 700 mm	Kč €	3220,- 135,-	157284	4820,- 201,-	157321	6150,- 257,-	157369	4820,- 201,-	157406
rozteč 900 mm / celková délka 1000 mm	Kč €	3520,- 147,-	157291	5120,- 214,-	157338	6450,- 269,-	157376	5120,- 214,-	157413
rozteč 1500 mm / celková délka 1600 mm	Kč €	3920,- 164,-	157307	5520,- 230,-	157345	6850,- 285,-	157383	5520,- 230,-	157420

Černá nerezová madla se dodávají v novém hrubém povrchu s označením K-industrial.

Titanové povrchy na madlech lze povlakovat individuálně podle rozsahu a charakteru zakázky.

Ceny modelů jsou uvedeny bez montážního materiálu. Montážní materiál je nutno specifikovat podle materiálu dveří. Tabulka montážního materiálu na str. 221.

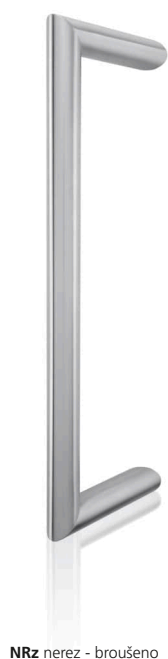

NRz nerez - broušeno



K-industrial černý mat strukturovaný



**Madlo Lusy Ø 30 mm  
vyosené**

4050,- Kč  
169,- EUR

**Madlo Andy Ø 30 mm  
vyosené**

4240,- Kč  
177,- EUR

**Madlo Andy II Ø 32 mm  
vyosené**

4700,- Kč  
196,- EUR

**Madlo Entero II □ 20/30 mm  
vyosené**

6380,- Kč  
266,- EUR

**Madlo Entero □ 30/30 mm  
vyosené**

6420,- Kč  
268,- EUR

materiál: nerezová ocel  
povrch: NRz nerez - broušeno

**KČ** **EUR**

4050,- 169,-

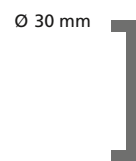

4240,- 177,-

4590,- 192,-

4240,- 177,-

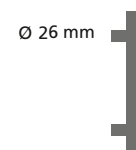

4370,- 183,-

4780,- 200,-

4700,- 196,-

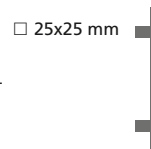

4840,- 202,-

5020,- 210,-

6380,- 266,-

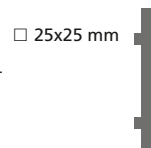

6530,- 273,-

6720,- 280,-

6420,- 268,-

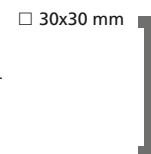

6590,- 275,-

6780,- 283,-

		NRz		TiN-C		K-industrial		TiN-A	
		cena / ks	EAN	cena / ks	EAN	cena / ks	EAN	cena / ks	EAN
rozteč 350 mm	Kč €	4050,- 169,-	030235	5650,- 236,-	030266	6980,- 291,-	030297	5650,- 236,-	030327
rozteč 550 mm	Kč €	4240,- 177,-	030242	5840,- 244,-	030273	7170,- 299,-	030303	5840,- 244,-	030334
rozteč 850 mm	Kč €	4590,- 192,-	030259	6940,- 290,-	030280	8260,- 345,-	030310	6940,- 290,-	030341
rozteč 350 mm celková délka 500 mm	Kč €	4240,- 177,-	030358	5840,- 244,-	030389	7170,- 299,-	030419	5840,- 244,-	030440
rozteč 550 mm celková délka 700 mm	Kč €	4370,- 183,-	030365	5990,- 250,-	030396	7310,- 305,-	030426	5990,- 250,-	030457
rozteč 850 mm celková délka 1000 mm	Kč €	4780,- 200,-	030372	7130,- 298,-	030402	8450,- 353,-	030433	7130,- 298,-	030464
rozteč 350 mm celková délka 500 mm	Kč €	4700,- 196,-	030471			7610,- 318,-	033755		
rozteč 550 mm celková délka 700 mm	Kč €	4840,- 202,-	030488			7760,- 324,-	033762		
rozteč 850 mm celková délka 1000 mm	Kč €	5020,- 210,-	030495			7930,- 331,-	033779		
rozteč 350 mm celková délka 500 mm	Kč €	6380,- 266,-	030501	7990,- 333,-	030532	9320,- 389,-	030563	7990,- 333,-	030594
rozteč 550 mm celková délka 700 mm	Kč €	6530,- 273,-	030518	8140,- 340,-	030549	9470,- 395,-	030570	8140,- 340,-	030600
rozteč 850 mm celková délka 1000 mm	Kč €	6720,- 280,-	030525	9050,- 378,-	030556	10390,- 433,-	030587	9050,- 378,-	030617
rozteč 350 mm	Kč €	6420,- 268,-	030624	8040,- 335,-	030655	9370,- 391,-	030686	8040,- 335,-	030716
rozteč 550 mm	Kč €	6590,- 275,-	030631	8200,- 342,-	030662	9540,- 398,-	030693	8200,- 342,-	030723
rozteč 850 mm	Kč €	6780,- 283,-	030648	9130,- 381,-	030679	10450,- 436,-	030709	9130,- 381,-	030730

Černá nerezová madla se dodávají v novém hrubém povrchu s označením K-industrial.

Titanové povrchy na madlech lze povlakovat individuálně podle rozsahu a charakteru zakázky.

Montážní materiál pro madla	cena sada	EAN
jednostranné s prošroubováním a záslepkou	Kč € 390,- 17,-	003024
jednostranné na sklo s prošroubováním a záslepkou	Kč € 510,- 22,-	003031
oboustranné	Kč € 390,- 17,-	003048
oboustranné na sklo	Kč € 510,- 22,-	003055

Montážní materiál pro madla	cena sada	EAN
jednostranné do slepé díry - plast	Kč € 390,- 17,-	030204
jednostranné do slepé díry - hliník	Kč € 390,- 17,-	030211
jednostranné do slepé díry - dřevo	Kč € 390,- 17,-	030228

Ceny madel jsou uvedeny bez montážního materiálu. Montážní materiál je nutno specifikovat podle materiálu dveří.

**M&T**  
m a g n e t i c





reddot winner 2020

double

Pro svůj výjimečný design obdržela madla Konzerva 220 a YES! spolu se systémem Magnetic prestižní mezinárodní ceny za design 2x RED DOT Design Award 2020.



reddot winner 2020



Příbuzný sortiment

[www.magnetic-mt.cz](http://www.magnetic-mt.cz)

Ovládací madla

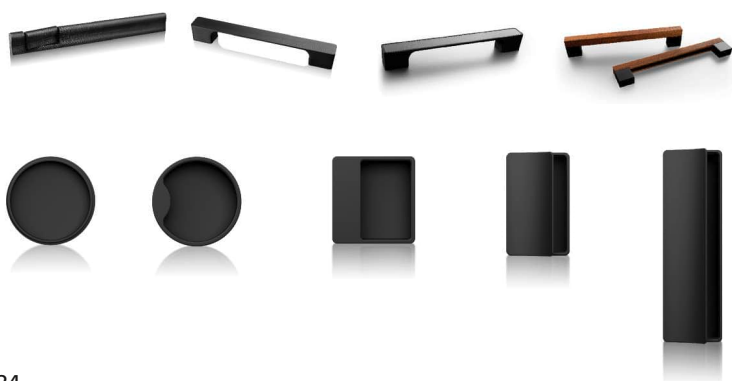

Neviditelné zárubně



Zapuštěné soklové lišty





## System Magnetic

Revoluční systém ovládání otočných dveří bez použití kliky a zámku. Do Magneticu jsme zapracovali řadu velmi silných magnetů a umístili je do dveřní zárubně, naproti do dveřního křídla jsme zasadili blok z magnetické nerez oceli. Při dovírání dveří se k sobě obě části přiblíží a působením magnetické síly zajistí plynulé dokonalé dovření. Magnetic disponuje jednoduchým seřízením výkonu magnetů při dovření dveří - dokonalý komfort na interiérových dveřích. I díky těmto přednostem obdržel Magnetic v roce 2020 mezinárodní cenu za design RED DOT Design Award.

Materiál: **kovová konstrukce + neodymové magnety**

Povrchy: **černá matná, bílá matná RAL 9003, broušená nerez efekt, satén nikel efekt**

Materiál: **kovová konstrukce + magnetická nerez ocel**

Povrchy: **černá matná, bílá matná RAL 9003, broušená nerez ocel**

### MAGNETIC



### MAGNETICKÝ BLOK

#### SEŘÍDITELNÝ



#### STANDARD



#### hlavní výhody

- systém bez zámku a bez kliky
- bez možnosti mechanického opotřebení součástek
- mnohonásobně delší životnost oproti klíče a zámku
- regulace síly ovládání dveří
- tiché ovládání dveří
- bezservisní a bezúdržbový systém
- inovativní design ovládacích madel

Patent

systém MAGNETIC

patent



**Držák / deska do obložkové zárubně**  
+ podložky 0,1 mm, 0,3 mm, 0,5 mm, 1 mm

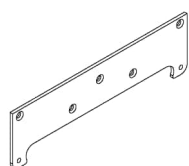

ocel, pozink  
EAN 112832 cena 130,- Kč / 5,5 EUR

### Montáž Magneticu

do obložkové zárubně šrouby TORX M5 × 20 mm

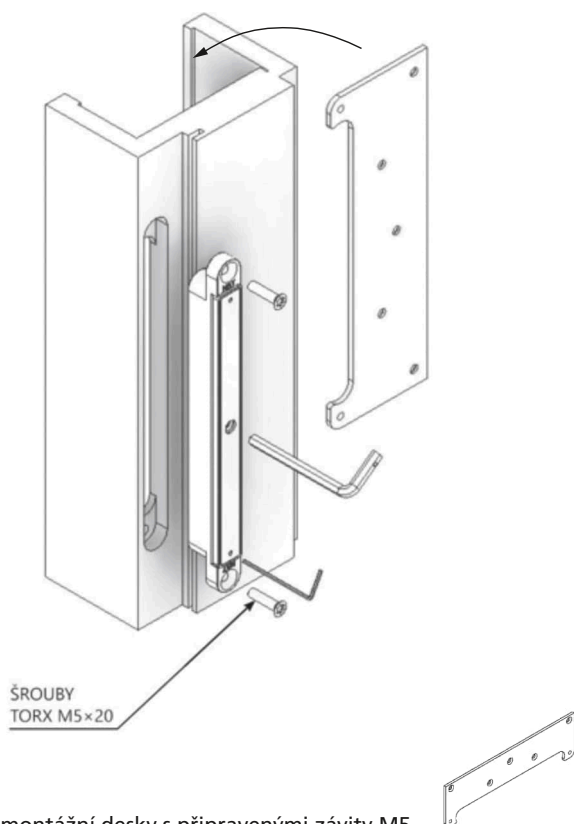

pomocí montážní desky s připravenými závitmi M5  
Montážní deska je přichycena vruty z vnitřní strany zárubně.

materiál: kovové tělo + neodymové magnety  
KČ povrch: černá matná EUR

### Magnetic

2350,-



98,-

2350,- Kč  
98,- EUR

materiál: kovové tělo + magnetická nerez ocel  
KČ povrch: černá matná EUR

### Magnetický blok

730,-

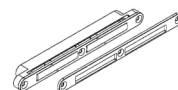

31,-

730,- Kč  
31,- EUR

270,-

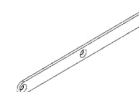

12,-

### Montážní magnet pr. 42 mm do obložkové zárubně

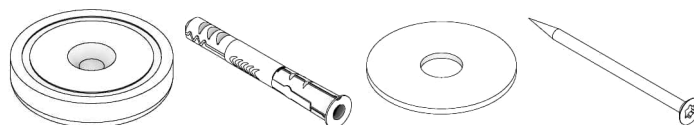

EAN 120837 cena 150,- Kč / 6,3 EUR

### Montáž zárubně

Zásadní důraz je potřeba klást na správné usazení obložkové zárubně. Magnetic má velkou sílu a při nesprávné montáži může odtrhnout zárubeň od zdi. Obložkovou zárubeň je třeba pěnit dvousložkovou pěnou (např. TKK Tekapur 2K foam, u M&T k dispozici).

Další variantou je usazení fixního magnetu průměr 42 mm na zeď pomocí hmoždinky Fischer Intelligent DUOPOWER (u M&T k dispozici). Magnet poté k sobě přitáhne obložkovou zárubeň (která je z vnitřní strany osazena montážní ocelovou deskou) a tím ji zamezí jakémukoliv pozdějšímu uvolnění.

### Montáž magnetu 42 mm na zdivo pomocí hmoždinky Fisher Intelligent DUOPOWER

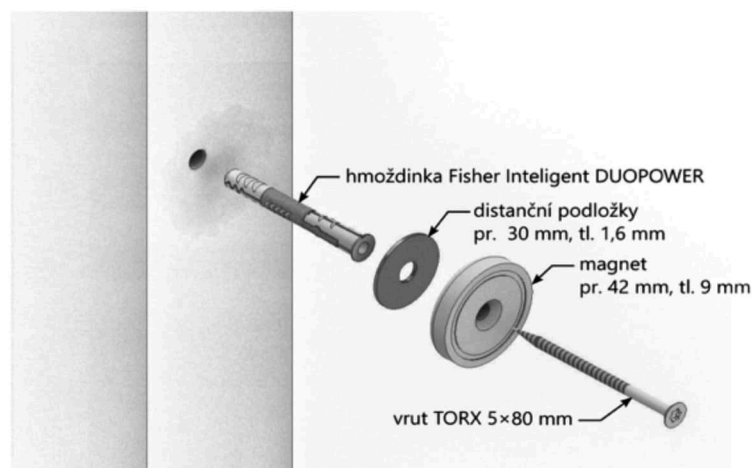

Při využití distančních podložek se použije vrut 90 mm.

	Černá matná		Satén nikel efekt		Bílá RAL 9003		Broušená nerez efekt	
	cena / ks	EAN	cena / ks	EAN	cena / ks	EAN	cena / ks	EAN
Kč €	2350,- 98,-	108613	2080,- 87,-	108651	2350,- 98,-	110609	2350,- 98,-	120806

	Černá matná		Broušená nerez		Bílá RAL 9003		
	cena / ks	EAN	cena / ks	EAN	cena / ks	EAN	
seřiditelný 0 / -2 / +2 mm	Kč €	730,- 31,-	108620	600,- 25,-	108668	730,- 31,-	110616
standard bez seřízení	Kč €	270,- 12,-	112603	170,- 7,1	112597	270,- 12,-	112610

[www.magnetic-mt.cz](http://www.magnetic-mt.cz)

## Seřízení Magneticu

Magnetic má seřízení pomocí imbus klíče (**KROK 1**), každá otáčka imbus klíče o 360 stupňů = výsun 1 mm desky s magnety.

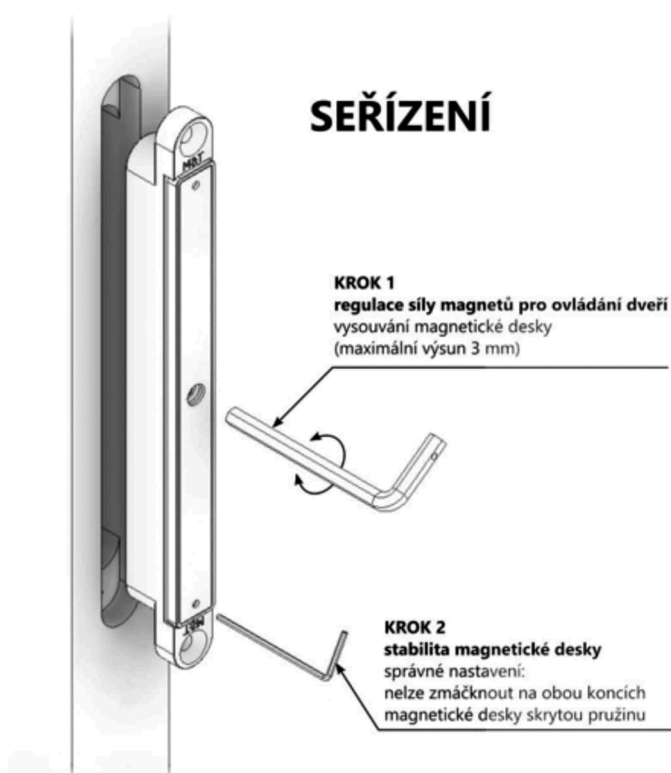

Po seřízení síly magnetů následuje **KROK 2** tj. zajištění stability magnetické desky na obou koncích pomocí malého imbusu.

Správné nastavení: nelze zmáčknout na obou koncích magnetické desky skrytou pružinku.

## KOLEKCE

### Magnetic

K magnetickému systému jsme navrhli inovativní úchopná madla, připravená pro jednoduché, ale účinné ovládání dveří.

Velkou předností modelů je propracovaná ergonomie a mimořádná stabilita na dveřích zaručující maximální komfort při ovládání.

Všechny modely jsou připraveny vždy ve více povrchových úpravách pro perfektní sjednocení s povrchem dveří a celým interiérem.

Veškeré modely madel jsou připraveny jak pro otočné, tak pro posuvné dveře.

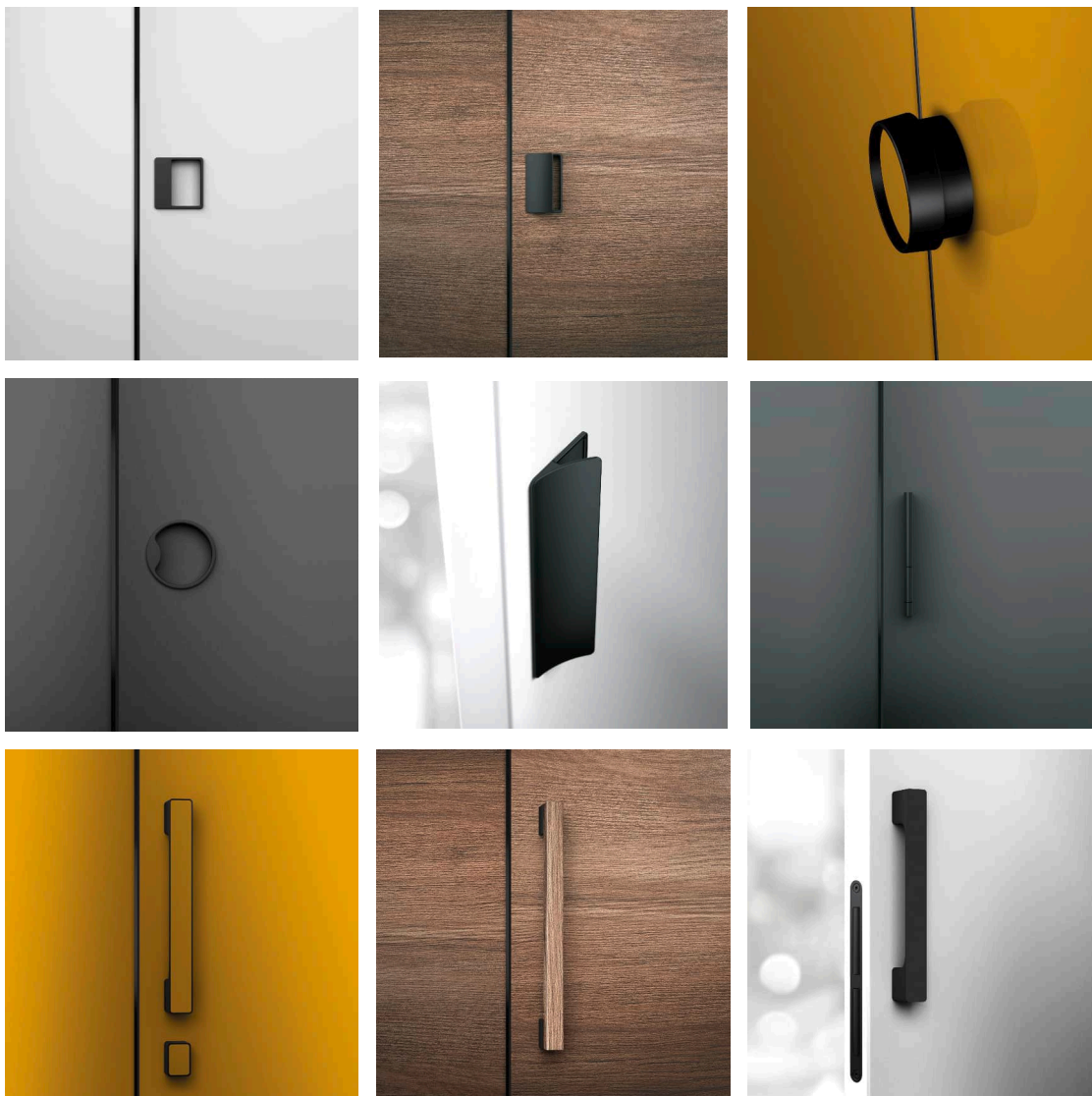

### Joo

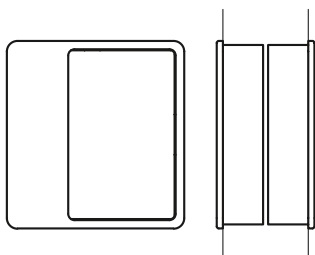

84x89 mm (ŠxV), výstup nad povrch dveří 3 mm

### Oko

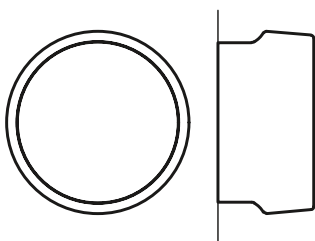

84x89 mm (ŠxV), výstup nad povrch dveří 33 mm

### Uff

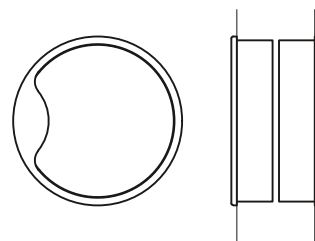

Ø 90 mm, výstup nad povrch dveří 3 mm

### Yes!

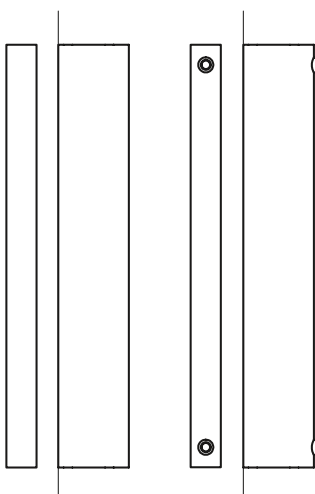

délky: 110, 210, 310, 610, 910 mm  
šířka: 15 mm  
výstup nad povrch dveří 35 mm

### Konzerva 110

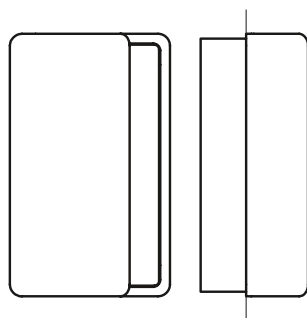

67x110 mm (ŠxV), výstup nad povrch dveří 25 mm

[www.magnetic-mt.cz](http://www.magnetic-mt.cz)

### Konzerva 220

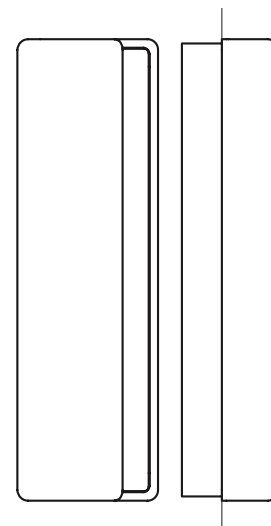

67x220 mm (ŠxV), výstup nad povrch dveří 25 mm

### Minimal

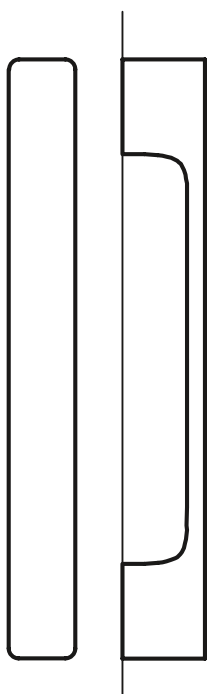

33x297 mm (ŠxV), výstup nad povrch dveří 40 mm

### Maximal

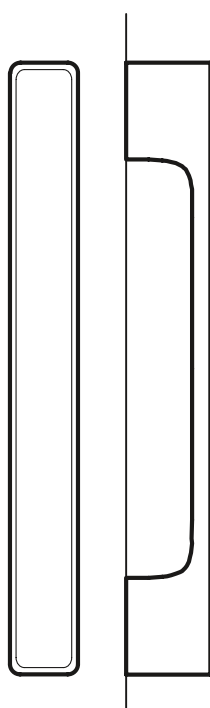

33x297 mm (ŠxV), výstup nad povrch dveří 40 mm

### Mimolimit

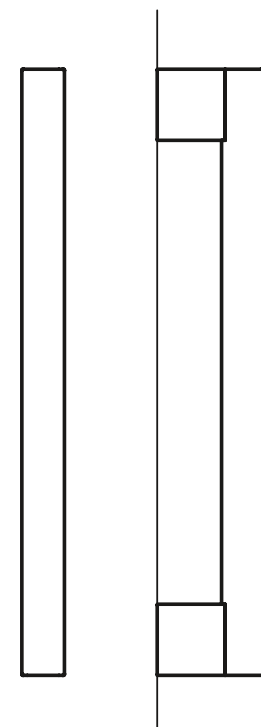

šířka 24 mm, výstup nad povrch dveří 61 mm



reddot winner 2020



Příbuzný sortiment

Magnetic



Neviditelné zárubně



Zapuštěné podlahové lišty



Posuvný systém Minima



## Ovládací madla k systému MAGNETIC

K magnetickému systému jsme navrhli inovativní úchopná madla, připravená pro jednoduché, ale účinné ovládání dveří. Velkou předností modelů je propracovaná ergonomie a mimořádná stabilita na dveřích zaručující maximální komfort při ovládání. Všechny modely jsou připraveny vždy ve více povrchových úpravách pro perfektní sjednocení s povrchem dveří a celým interiérem. Tím jsme docílili dokonalého celku, kdy u vybraných modelů madel tj. JOO, UFF, KONZERVA 110 a KONZERVA 220, dokážeme pomocí magnetických destiček vyplnit ovládací prostor madla identickým povrchem s dveřmi a tak připravit efekt částečně skrytého madla, kdy zůstává viditelná pouze okrajová kontura madla + úchopná plocha, vše ostatní je skryto ve dveřích. Součástí madla YES! je integrované zamykání WC/koupelna, což přináší dosud nepoznaný dojem. Pro svůj výjimečný design obdržela madla Konzerva 220 a YES! prestižní mezinárodní cenu za design RED DOT Design Award 2020.

Veškeré modely madel jsou připraveny jak pro otočné, tak pro posuvné dveře.

Materiál: masivní mosaz

Povrchy: SNI, Cr, Cr-K, Ms-L, Ms-A, TiN-C, TiN-K, TiN-B, TiN-A

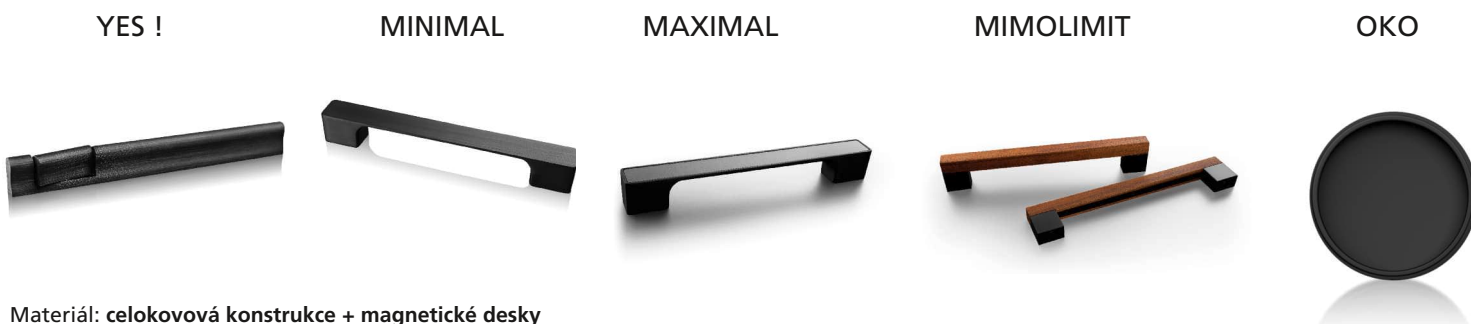

Materiál: celokovová konstrukce + magnetické desky

Povrchy: SNI, Cr, TiN-K



### konstrukční varianty

- sady madel se zamykáním jsou dodávány vždy v ceně se zámkem
- povrch dodávaného čela zámku k madlu je uveden v tabulkách cen a EAN kódů vedle povrchu madla za lomítkem
- zapuštěná madla jsou montážně připravena na dveře od tl. 38 mm
- madla Minimal, Maximal, Mimolimit, OKO, YES! dodáváme ve variantě oboustranné i jednostranné
- madla UFF, JOO, Konzerva 110, Konzerva 220 ve variantě oboustranné
- výkresy vrtání, frézování na [www.kliky-mt.cz/montaze-kovani](http://www.kliky-mt.cz/montaze-kovani)
- záruka 3 roky, titany 15 let, madla z masivní mosazi bez povrchu – doživotní záruka

roky **3 garance** | let **15 garance**



Ochranné známky – registrované značky **MINIMAL®** **MAXIMAL®**



Chráněné průmyslové vzory madel  
JOO, UFF, Konzerva 110, Konzerva 220, OKO, Minimal, Maximal, Mimolimit, YES !



Patenty  
• montážní konstrukce se systémem magnetických desek u madel JOO, UFF, KONZERVA



**Madlo Joo**  
+ magnetická výplň v povrchu madla

2380,- Kč  
100,- EUR

**Magnetická výplň  
madla Joo**

200,- Kč  
8,4 EUR

materiál: kovové tělo + magnetická výplň  
Kč povrch: TiN-K titan černý mat EUR

2380,-

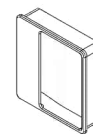

100,-

materiál: magnetická výplň  
Kč povrch: bílá matná EUR

200,-



8,4

materiál: kovové tělo + magnetická výplň  
Kč povrch: TiN-K titan černý mat EUR

2650,-

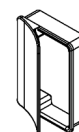

111,-

**Madlo Konzerva**  
+ magnetická výplň v povrchu madla

2650,- Kč  
111,- EUR

4260,-

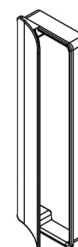

178,-

materiál: magnetická výplň  
Kč povrch: bílá matná EUR

200,-



8,4

310,-



13,-

**Magnetická výplň  
madla Konzerva**

200,- Kč  
8,4 EUR

materiál: masivní mosaz  
Kč povrch: TiN-K titan černý mat EUR

1830,-

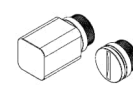

77,-

**WC hranaté bezrozetové**  
+ zámek + protiplech

1830,- Kč  
77,- EUR

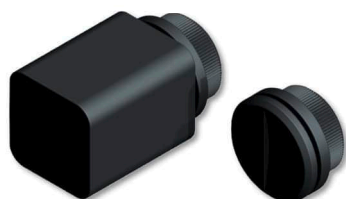



	<b>TiN-K</b>		<b>SNi</b>		<b>Cr</b>	
	cena / pár	EAN	cena / pár	EAN	cena / pár	EAN
Kč €	2380,- 100,-	108804	1600,- 67,-	108781	2110,- 88,-	108798

Součástí výrobku a ceny je standardně výplň v povrchu madla.

Nadstandardní výplň	<b>Bílá matná</b>		<b>Bílá lesklá</b>		<b>Zakázková výroba</b>	
	cena / pár	EAN	cena / pár	EAN	cena / pár	EAN
Kč €	200,- 8,4	110623	200,- 8,4	110630	270,- 12,-	110647

	<b>TiN-K</b>		<b>SNi</b>	
	cena / pár	EAN	cena / pár	EAN
110 mm Kč €	2650,- 111,-	108828	1990,- 83,-	108675
220 mm Kč €	4260,- 178,-	108644	3320,- 139,-	108835

Součástí výrobku a ceny je standardně výplň v povrchu madla.

Nadstandardní výplň	<b>Bílá matná</b>		<b>Bílá lesklá</b>		<b>Zakázková výroba</b>	
	cena / pár	EAN	cena / pár	EAN	cena / pár	EAN
110 mm Kč €	200,- 8,4	110661	200,- 8,4	110678	270,- 12,-	110685
220 mm Kč €	310,- 13,-	110692	310,- 13,-	110708	400,- 17,-	110715

	<b>TiN-K / TiN-K</b>		<b>SNi / nerez</b>		<b>Cr / nerez</b>	
	cena / set	EAN	cena / set	EAN	cena / set	EAN
Kč €	1830,- 77,-	108637	1210,- 51,-	109382	1540,- 65,-	110654

První uvedený povrch je povrch WC mechanismu, druhý za lomítkem je povrch čela zámku a protiplechu.



**Madlo Uff**  
+ magnetická výplň v povrchu madla

2540,- Kč  
106,- EUR

materiál: kovové tělo + magnetická výplň  
Kč povrch: TiN-K titan černý mat EUR

2540,-



106,-

**Magnetická výplň  
madla Uff**

200,- Kč  
8,4 EUR

materiál: magnetická výplň  
Kč povrch: bílá matná EUR

200,-



8,4



**Madlo Oko**

5320,- Kč  
222,- EUR

materiál: masivní mosaz + magnetická výplň  
Kč povrch: TiN-K titan černý mat EUR

5320,-



222,-

**Magnetická výplň  
Madlo Oko**

200,- Kč  
8,4 EUR

materiál: magnetická výplň  
Kč povrch: bílá matná EUR

200,-



8,4



**WC kulaté bezrozetové**  
+ zámek + protiplech

1830,- Kč  
77,- EUR

materiál: masivní mosaz  
Kč povrch: TiN-K titan černý mat EUR

1830,-

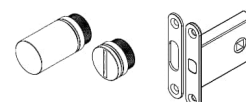

77,-

	TiN-K		Sni		Cr	
	cena / pár	EAN	cena / pár	EAN	cena / pár	EAN
Kč €	2540,- 106,-	108873	1730,- 73,-	108859	2240,- 94,-	108866

Součástí výrobku a ceny je standardně výplň v povrchu madla.

Nadstandardní výplň	Bílá matná		Bílá lesklá		Zakázková výroba	
	cena / pár	EAN	cena / pár	EAN	cena / pár	EAN
Kč €	200,- 8,4	110722	200,- 8,4	110739	270,- 12,-	110746



	TiN-K		Sni		Sni - broušeno		Ms-A		Ms-L	
	cena / pár	EAN	cena / pár	EAN	cena / pár	EAN	cena / pár	EAN	cena / pár	EAN
Kč €	5320,- 222,-	111743	4100,- 171,-	111682	4180,- 175,-	111699	4400,- 184,-	111774	4400,- 184,-	111712

	Cr		Cr-K		TiN-C		TiN-B		TiN-A	
	cena / pár	EAN	cena / pár	EAN	cena / pár	EAN	cena / pár	EAN	cena / pár	EAN
Kč €	4400,- 184,-	111705	5870,- 245,-	111729	5320,- 222,-	111736	5320,- 222,-	111750	5320,- 222,-	111767

Madlo Oko je dodáváno bez vnitřní magnetické volitelné výplně, která se objednává samostatně.

	Bílá matná		Sni		Cr		TiN-K		Bílá lesklá	
	cena / pár	EAN	cena / pár	EAN	cena / pár	EAN	cena / pár	EAN	cena / pár	EAN
Kč €	200,- 8,4	111910	200,- 8,4	111880	200,- 8,4	111897	270,- 12,-	111903	200,- 8,4	111927

	TiN-C		TiN-A		TiN-B	
	cena / pár	EAN	cena / pár	EAN	cena / pár	EAN
Kč €	270,- 12,-	111934	270,- 12,-	111941	270,- 12,-	111958

	TiN-K / TiN-K		Sni / nerez		Cr / nerez	
	cena / set	EAN	cena / set	EAN	cena / set	EAN
Kč €	1830,- 77,-	110777	1210,- 51,-	110753	1540,- 65,-	110760

Další povrchy WC  
na [www.kliky-mt.cz/katalog](http://www.kliky-mt.cz/katalog).

První uvedený povrch je povrch WC mechanismu, druhý za lomítkem je povrch čela zámku a protiplechu.

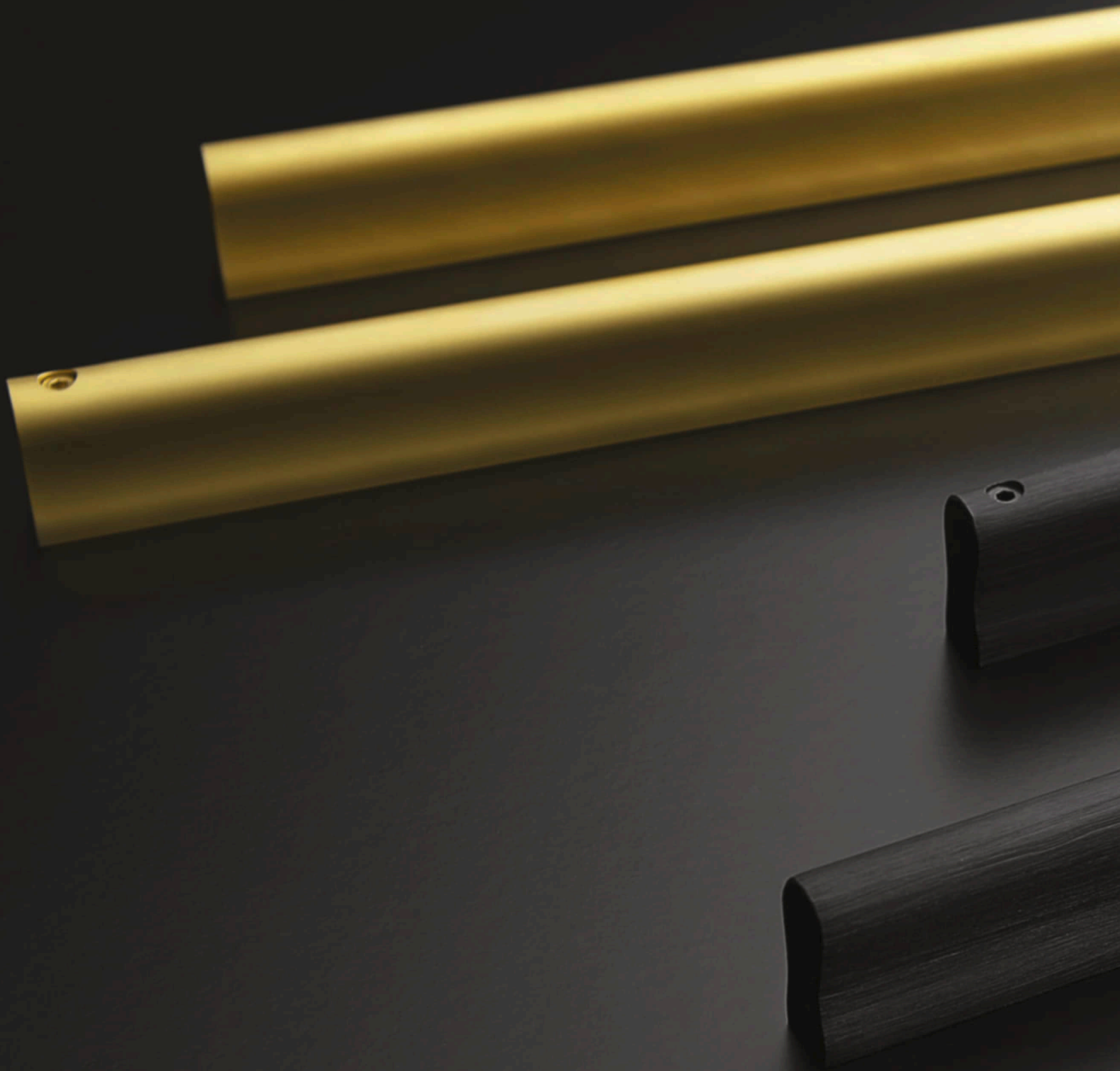





**Madlo Yes!**

4650,- Kč  
 194,- EUR

materiál: masivní mosaz  
 povrch: TiN-K titan černý mat

Kč	EUR
4650,-	194,-
5670,-	237,-
6960,-	290,-
10590,-	442,-
13920,-	580,-

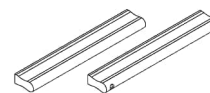

**Madlo Yes! WC**  
 + zámek + protiplech

8560,- Kč  
 357,- EUR

materiál: masivní mosaz  
 povrch: TiN-K titan černý mat

Kč	EUR
8560,-	357,-
9860,-	411,-
13480,-	562,-
16820,-	701,-

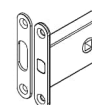
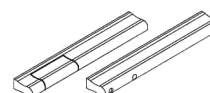



	TiN-K		SNI		SNI - broušeno		Ms-A		Ms-L		
	cena / pár	EAN	cena / pár	EAN	cena / pár	EAN	cena / pár	EAN	cena / pár	EAN	
110 mm	Kč €	4650,- 194,-	111132	3500,- 146,-	110784	3630,- 152,-	110838	4070,- 170,-	111033	4070,- 170,-	110982
210 mm	Kč €	5670,- 237,-	111149	4510,- 188,-	110791	4650,- 194,-	110845	5080,- 212,-	111040	5080,- 212,-	110999
310 mm	Kč €	6960,- 290,-	111156	5670,- 237,-	110807	5810,- 243,-	110852	6240,- 260,-	111057	6240,- 260,-	111002
610 mm	Kč €	10590,- 442,-	111163	8420,- 351,-	110814	8560,- 357,-	110869			9290,- 388,-	111019
910 mm	Kč €	13920,- 580,-	111170	11900,- 496,-	110821	12190,- 508,-	110876			12630,- 527,-	111026

	Cr		Cr-K		TiN-C		TiN-B		TiN-A		
	cena / pár	EAN	cena / pár	EAN	cena / pár	EAN	cena / pár	EAN	cena / pár	EAN	
110 mm	Kč €	3940,- 165,-	110883	5240,- 219,-	110937	4650,- 194,-	111088	4650,- 194,-	111187	4650,- 194,-	111231
210 mm	Kč €	4940,- 206,-	110890	6520,- 272,-	110944	5670,- 237,-	111095	5670,- 237,-	111194	5670,- 237,-	111248
310 mm	Kč €	6110,- 255,-	110906	8120,- 339,-	110951	6960,- 290,-	111101	6960,- 290,-	111200	6960,- 290,-	111255
610 mm	Kč €	9000,- 375,-	110913	12470,- 520,-	110968	10590,- 442,-	111118	10590,- 442,-	111217	10590,- 442,-	111262
910 mm	Kč €	12630,- 527,-	110920	16380,- 683,-	110975	13920,- 580,-	111125	13920,- 580,-	111224	13920,- 580,-	111279

Pro montáž na skleněné dveře je třeba doobjednat montážní materiál pro madlo Yes! na sklo str. 241.



	TiN-K / TiN-K		SNI / nerez		SNI - br. / nerez		Ms-A / TiN-K		Ms-L / TiN-K		
	cena / set	EAN	cena / set	EAN	cena / set	EAN	cena / set	EAN	cena / set	EAN	
210 mm	Kč €	8560,- 357,-	111569	7410,- 309,-	111286	7550,- 315,-	111323	7980,- 333,-	111484	7980,- 333,-	111446
310 mm	Kč €	9860,- 411,-	111576	8560,- 357,-	110593	8700,- 363,-	111330	9130,- 381,-	111491	9130,- 381,-	111453
610 mm	Kč €	13480,- 562,-	111583	11310,- 472,-	111309	11460,- 478,-	111347			12190,- 508,-	111460
910 mm	Kč €	16820,- 701,-	111590	14800,- 617,-	111316	15080,- 629,-	111354			15520,- 647,-	111477

	Cr / nerez		Cr-K / TiN-K		TiN-C / nerez		TiN-B / TiN-K		TiN-A / TiN-K		
	cena / set	EAN	cena / set	EAN	cena / set	EAN	cena / set	EAN	cena / set	EAN	
210 mm	Kč €	7840,- 327,-	111361	10020,- 418,-	111408	8560,- 357,-	111521	8560,- 357,-	111606	8560,- 357,-	111644
310 mm	Kč €	9000,- 375,-	111378	11460,- 478,-	111415	9860,- 411,-	111538	9860,- 411,-	111613	9860,- 411,-	111651
610 mm	Kč €	11900,- 496,-	111385	14070,- 587,-	111422	13480,- 562,-	111545	13480,- 562,-	111620	13480,- 562,-	111668
910 mm	Kč €	15520,- 647,-	111392	19860,- 828,-	111439	16820,- 701,-	111552	16820,- 701,-	111637	16820,- 701,-	111675



První uvedený povrch je povrch madla, druhý za lomítkem je povrch čela zámku a protiplechu.



**Madlo Yes! WC double**  
 + zámek + protiplech

9420,- Kč  
 393,- EUR

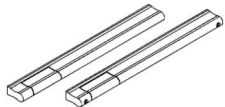
materiál: masivní mosaz  
 povrch: TiN-K titan černý mat

Kč		EUR
9420,-		393,-
10730,-		448,-
14350,-		598,-
17690,-		738,-

**Madlo Yes! jednostranné**

2330,- Kč  
 98,- EUR

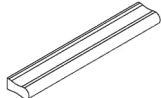

materiál: masivní mosaz  
 povrch: TiN-K titan černý mat

Kč		EUR
2330,-		98,-
2840,-		119,-
3500,-		146,-
5300,-		221,-
6960,-		290,-





		TiN-K / TiN-K		Sni / nerez		Sni - br. / nerez		Ms-A / TiN-K		Ms-L / TiN-K	
		cena / set	EAN	cena / set	EAN	cena / set	EAN	cena / set	EAN	cena / set	EAN
210 mm	Kč €	9420,- 393,-	126129	8280,- 345,-	125849	8420,- 351,-	125887	8850,- 369,-	126044	8850,- 369,-	126006
310 mm	Kč €	10730,- 448,-	126136	9420,- 393,-	125856	9570,- 399,-	125894	10020,- 418,-	126051	10020,- 418,-	126013
610 mm	Kč €	14350,- 598,-	126143	12190,- 508,-	125863	12320,- 514,-	125900			13040,- 544,-	126020
910 mm	Kč €	17690,- 738,-	126150	15650,- 653,-	125870	15940,- 665,-	125917			16380,- 683,-	126037

		Cr / nerez		Cr-K / TiN-K		TiN-C / nerez		TiN-B / TiN-K		TiN-A / TiN-K	
		cena / set	EAN	cena / set	EAN	cena / set	EAN	cena / set	EAN	cena / set	EAN
210 mm	Kč €	8700,- 363,-	125924	10870,- 453,-	125962	9420,- 393,-	126082	9420,- 393,-	126167	9420,- 393,-	126204
310 mm	Kč €	9860,- 411,-	125931	12320,- 514,-	125979	10730,- 448,-	126099	10730,- 448,-	126174	10730,- 448,-	126211
610 mm	Kč €	12760,- 532,-	125948	14930,- 623,-	125986	14350,- 598,-	126105	14350,- 598,-	126181	14350,- 598,-	126228
910 mm	Kč €	16380,- 683,-	125955	20720,- 864,-	125993	17690,- 738,-	126112	17690,- 738,-	126198	17690,- 738,-	126235

První uvedený povrch je povrch madla, druhý za lomítkem je povrch čela zámku a protiplechu.



		TiN-K		Sni		Sni - broušeno		Ms-A		Ms-L	
		cena / ks	EAN	cena / ks	EAN	cena / ks	EAN	cena / ks	EAN	cena / ks	EAN
110 mm	Kč €	2330,- 98,-	123531	1760,- 74,-	123180	1830,- 77,-	123234	2040,- 85,-	123432	2040,- 85,-	123388
210 mm	Kč €	2840,- 119,-	123548	2270,- 95,-	123197	2330,- 98,-	123241	2550,- 107,-	123449	2550,- 107,-	123395
310 mm	Kč €	3500,- 146,-	123555	2840,- 119,-	123203	2910,- 122,-	123258	3130,- 131,-	123456	3130,- 131,-	123401
610 mm	Kč €	5300,- 221,-	123562	4220,- 176,-	123210	4280,- 179,-	123265			4650,- 194,-	123418
910 mm	Kč €	6960,- 290,-	123579	5950,- 248,-	123227	6110,- 255,-	123272			6320,- 264,-	123425

		Cr		Cr-K		TiN-C		TiN-B		TiN-A	
		cena / ks	EAN	cena / ks	EAN	cena / ks	EAN	cena / ks	EAN	cena / ks	EAN
110 mm	Kč €	1980,- 83,-	123289	2630,- 110,-	123333	2330,- 98,-	123487	2330,- 98,-	123586	2330,- 98,-	123630
210 mm	Kč €	2480,- 104,-	123296	3280,- 137,-	123340	2840,- 119,-	123494	2840,- 119,-	123593	2840,- 119,-	123647
310 mm	Kč €	3060,- 128,-	123302	4070,- 170,-	123357	3500,- 146,-	123500	3500,- 146,-	123609	3500,- 146,-	123654
610 mm	Kč €	4510,- 188,-	123319	6240,- 260,-	123364	5300,- 221,-	123517	5300,- 221,-	123616	5300,- 221,-	123661
910 mm	Kč €	6320,- 264,-	123326	8190,- 342,-	123371	6960,- 290,-	123524	6960,- 290,-	123623	6960,- 290,-	123678

Montážní materiál k madlu Yes! na sklo		Sni		Cr		TiN-C		TiN-K		TiN-B		TiN-A	
		cena / sada	EAN	cena / sada	EAN	cena / sada	EAN	cena / sada	EAN	cena / sada	EAN	cena / sada	EAN
na sklo 8 - 12 mm	Kč €	340,- 15,-	112511	340,- 15,-	155495	450,- 19,-	155501	450,- 19,-	155518	450,- 19,-	155525	450,- 19,-	155532

Pro montáž na skleněné dveře je třeba doobjednat montážní materiál pro madlo Yes! na sklo.

**Madlo Yes! s otvorem**

4940,- Kč  
 206,- EUR

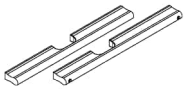

materiál: masivní mosaz  
 povrch: TiN-K titan černý mat

Kč		EUR
4940,-		206,-
5950,-		248,-
7250,-		303,-
10870,-		453,-
14210,-		593,-



**Madlo Yes! WC s otvorem**

+ zámek + protiplech

8850,- Kč  
 369,- EUR

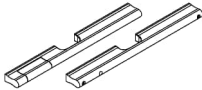

materiál: masivní mosaz  
 povrch: TiN-K titan černý mat

Kč		EUR
8850,-		369,-
10150,-		423,-
13770,-		574,-
17110,-		713,-



		TiN-K		SNI		SNI - broušeno		Ms-A		Ms-L	
		cena / pár	EAN	cena / pár	EAN	cena / pár	EAN	cena / pár	EAN	cena / pár	EAN
110 mm	Kč €	4940,- 206,-	113914	3780,- 158,-	113563	3940,- 165,-	113617	4350,- 182,-	113815	4350,- 182,-	113761
210 mm	Kč €	5950,- 248,-	113921	4790,- 200,-	113570	4940,- 206,-	113624	5380,- 225,-	113822	5380,- 225,-	113778
310 mm	Kč €	7250,- 303,-	113938	5950,- 248,-	113587	6110,- 255,-	113631	6520,- 272,-	113839	6520,- 272,-	113785
610 mm	Kč €	10870,- 453,-	113945	8700,- 363,-	113594	8850,- 369,-	113648			9570,- 399,-	113792
910 mm	Kč €	14210,- 593,-	113952	12190,- 508,-	113600	12470,- 520,-	113655			12910,- 538,-	113808

		Cr		Cr-K		TiN-C		TiN-B		TiN-A	
		cena / pár	EAN	cena / pár	EAN	cena / pár	EAN	cena / pár	EAN	cena / pár	EAN
110 mm	Kč €	4220,- 176,-	113662	5520,- 230,-	113716	4940,- 206,-	113860	4940,- 206,-	113969	4940,- 206,-	114010
210 mm	Kč €	5240,- 219,-	113679	6830,- 285,-	113723	5950,- 248,-	113877	5950,- 248,-	113976	5950,- 248,-	114027
310 mm	Kč €	6390,- 267,-	113686	8420,- 351,-	113730	7250,- 303,-	113884	7250,- 303,-	113983	7250,- 303,-	114034
610 mm	Kč €	9290,- 388,-	113693	12760,- 532,-	113747	10870,- 453,-	113891	10870,- 453,-	113990	10870,- 453,-	114041
910 mm	Kč €	12910,- 538,-	113709	16670,- 695,-	113754	14210,- 593,-	113907	14210,- 593,-	114003	14210,- 593,-	114058

Pro montáž na skleněné dveře je třeba doobjednat montážní materiál pro madlo Yes! na sklo str. 245.



		TiN-K / TiN-K		SNI / nerez		SNI - br. / nerez		Ms-A / TiN-K		Ms-L / TiN-K	
		cena / set	EAN	cena / set	EAN	cena / set	EAN	cena / set	EAN	cena / set	EAN
210 mm	Kč €	8850,- 369,-	114348	7690,- 321,-	114065	7840,- 327,-	114102	8280,- 345,-	114263	8280,- 345,-	114225
310 mm	Kč €	10150,- 423,-	114355	8850,- 369,-	114072	9000,- 375,-	114119	9420,- 393,-	114270	9420,- 393,-	114232
610 mm	Kč €	13770,- 574,-	114362	11600,- 484,-	114089	11740,- 490,-	114126			12470,- 520,-	114249
910 mm	Kč €	17110,- 713,-	114379	15080,- 629,-	114096	15370,- 641,-	114133			15810,- 659,-	114256

		Cr / nerez		Cr-K / TiN-K		TiN-C / nerez		TiN-B / TiN-K		TiN-A / TiN-K	
		cena / set	EAN	cena / set	EAN	cena / set	EAN	cena / set	EAN	cena / set	EAN
210 mm	Kč €	8120,- 339,-	114140	10300,- 430,-	114188	8850,- 369,-	114300	8850,- 369,-	114386	8850,- 369,-	114423
310 mm	Kč €	9290,- 388,-	114157	11740,- 490,-	114195	10150,- 423,-	114317	10150,- 423,-	114393	10150,- 423,-	114430
610 mm	Kč €	12190,- 508,-	114164	14350,- 598,-	114201	13770,- 574,-	114324	13770,- 574,-	114409	13770,- 574,-	114447
910 mm	Kč €	15810,- 659,-	114171	20150,- 840,-	114218	17110,- 713,-	114331	17110,- 713,-	114416	17110,- 713,-	114454

První uvedený povrch je povrch madla, druhý za lomítkem je povrch čela zámku a protiplechu.

**Madlo Yes! WC double s otvorem**  
 + zámek + protiplech



9730,- Kč  
 406,- EUR

materiál: masivní mosaz  
 povrch: TiN-K titan černý mat

Kč	EUR
9730,-	406,-
11030,-	460,-
14640,-	610,-
17980,-	750,-

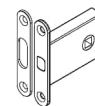
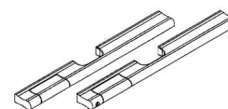

**Madlo Yes!**  
 jednostranné s otvorem



2480,- Kč  
 104,- EUR

materiál: masivní mosaz  
 povrch: TiN-K titan černý mat

Kč	EUR
2480,-	104,-
2980,-	125,-
3630,-	152,-
5450,-	228,-
7120,-	297,-

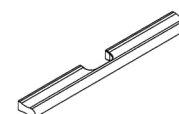



		TiN-K / TiN-K		Sni / nerez		Sni - br. / nerez		Ms-A / TiN-K		Ms-L / TiN-K	
		cena / set	EAN	cena / set	EAN	cena / set	EAN	cena / set	EAN	cena / set	EAN
210 mm	Kč €	9730,- 406,-	126525	8560,- 357,-	126242	8700,- 363,-	126280	9130,- 381,-	126440	9130,- 381,-	126402
310 mm	Kč €	11030,- 460,-	126532	9730,- 406,-	126259	9860,- 411,-	126297	10300,- 430,-	126457	10300,- 430,-	126419
610 mm	Kč €	14640,- 610,-	126549	12470,- 520,-	126266	12630,- 527,-	126303			13340,- 556,-	126426
910 mm	Kč €	17980,- 750,-	126556	15940,- 665,-	126273	16240,- 677,-	126310			16670,- 695,-	126433

		Cr / nerez		Cr-K / TiN-K		TiN-C / nerez		TiN-B / TiN-K		TiN-A / TiN-K	
		cena / set	EAN	cena / set	EAN	cena / set	EAN	cena / set	EAN	cena / set	EAN
210 mm	Kč €	9000,- 375,-	126327	11170,- 466,-	126365	9730,- 406,-	126488	9730,- 406,-	126563	9730,- 406,-	126600
310 mm	Kč €	10150,- 423,-	126334	12630,- 527,-	126372	11030,- 460,-	126495	11030,- 460,-	126570	11030,- 460,-	126617
610 mm	Kč €	13040,- 544,-	126341	15210,- 634,-	126389	14640,- 610,-	126501	14640,- 610,-	126587	14640,- 610,-	126624
910 mm	Kč €	16670,- 695,-	126358	21020,- 876,-	126396	17980,- 750,-	126518	17980,- 750,-	126594	17980,- 750,-	126631

První uvedený povrch je povrch madla, druhý za lomítkem je povrch čela zámku a protiplechu.



		TiN-K		Sni		Sni - broušeno		Ms-A		Ms-L	
		cena / ks	EAN	cena / ks	EAN	cena / ks	EAN	cena / ks	EAN	cena / ks	EAN
110 mm	Kč €	2480,- 104,-	124033	1900,- 80,-	123685	1980,- 83,-	123739	2180,- 91,-	123937	2180,- 91,-	123883
210 mm	Kč €	2980,- 125,-	124040	2400,- 100,-	123692	2480,- 104,-	123746	2700,- 113,-	123944	2700,- 113,-	123890
310 mm	Kč €	3630,- 152,-	124057	2980,- 125,-	123708	3060,- 128,-	123753	3280,- 137,-	123951	3280,- 137,-	123906
610 mm	Kč €	5450,- 228,-	124064	4350,- 182,-	123715	4440,- 185,-	123760			4790,- 200,-	123913
910 mm	Kč €	7120,- 297,-	124071	6110,- 255,-	123722	6240,- 260,-	123777			6460,- 270,-	123920

		Cr		Cr-K		TiN-C		TiN-B		TiN-A	
		cena / ks	EAN	cena / ks	EAN	cena / ks	EAN	cena / ks	EAN	cena / ks	EAN
110 mm	Kč €	2110,- 88,-	123784	2770,- 116,-	123838	2480,- 104,-	123982	2480,- 104,-	124088	2480,- 104,-	124132
210 mm	Kč €	2630,- 110,-	123791	3420,- 143,-	123845	2980,- 125,-	123999	2980,- 125,-	124095	2980,- 125,-	124149
310 mm	Kč €	3210,- 134,-	123807	4220,- 176,-	123852	3630,- 152,-	124002	3630,- 152,-	124101	3630,- 152,-	124156
610 mm	Kč €	4650,- 194,-	123814	6390,- 267,-	123869	5450,- 228,-	124019	5450,- 228,-	124118	5450,- 228,-	124163
910 mm	Kč €	6460,- 270,-	123821	8350,- 348,-	123876	7120,- 297,-	124026	7120,- 297,-	124125	7120,- 297,-	124170

Montážní materiál k madlu Yes! na sklo		Sni		Cr		TiN-C		TiN-K		TiN-B		TiN-A	
		cena / sada	EAN	cena / sada	EAN	cena / sada	EAN	cena / sada	EAN	cena / sada	EAN	cena / sada	EAN
na sklo	Kč	340,-	112511	340,-	155495	450,-	155501	450,-	155518	450,-	155525	450,-	155532
8 - 12 mm	€	15,-		15,-		19,-		19,-		19,-		19,-	

Pro montáž na skleněné dveře je třeba doobjednat montážní materiál pro madlo Yes! na sklo.

## Varianty provedení madla Yes!

### Madlo Yes!

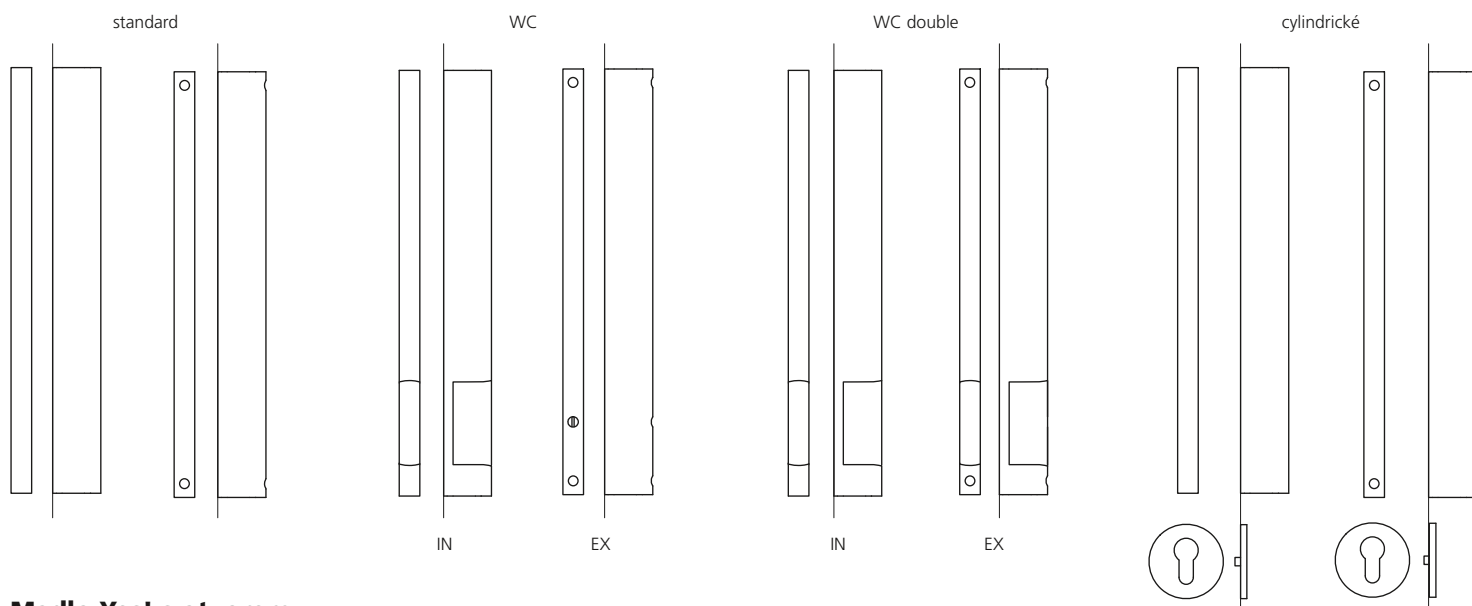

### Madlo Yes! s otvorem

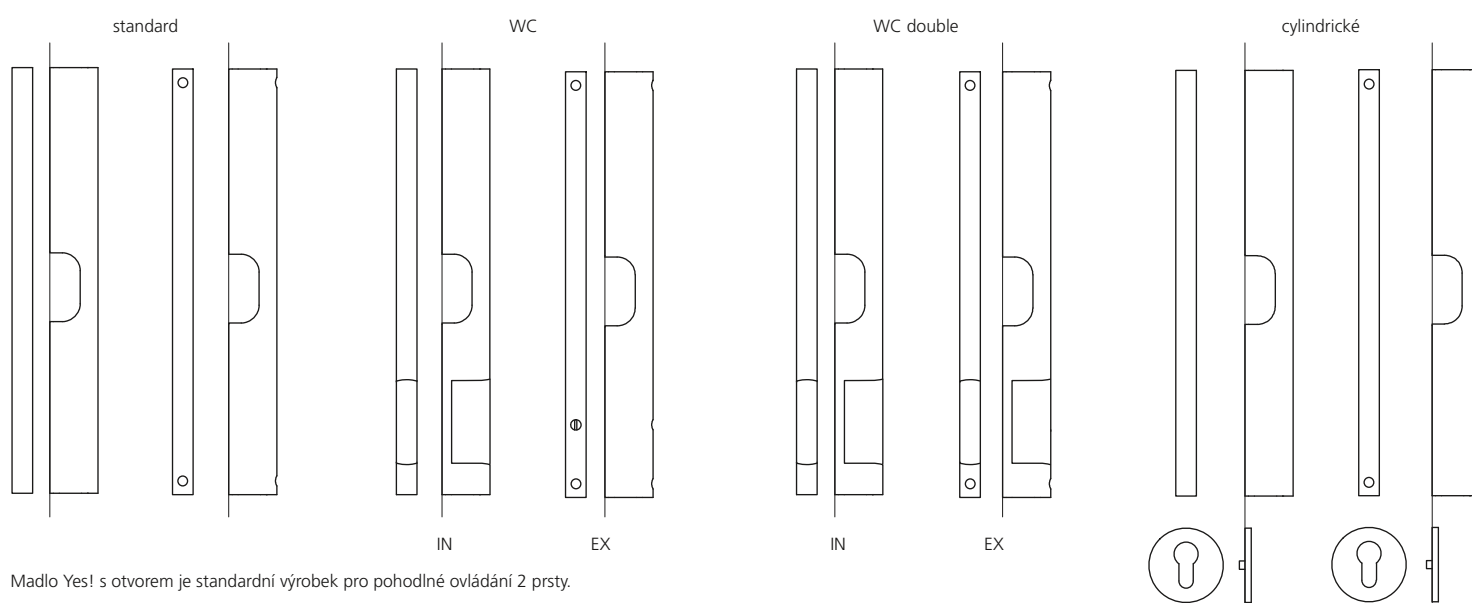

Madlo Yes! s otvorem je standardní výrobek pro pohodlné ovládání 2 prsty.

### Madlo Yes! s otvorem 90 mm pro celou ruku

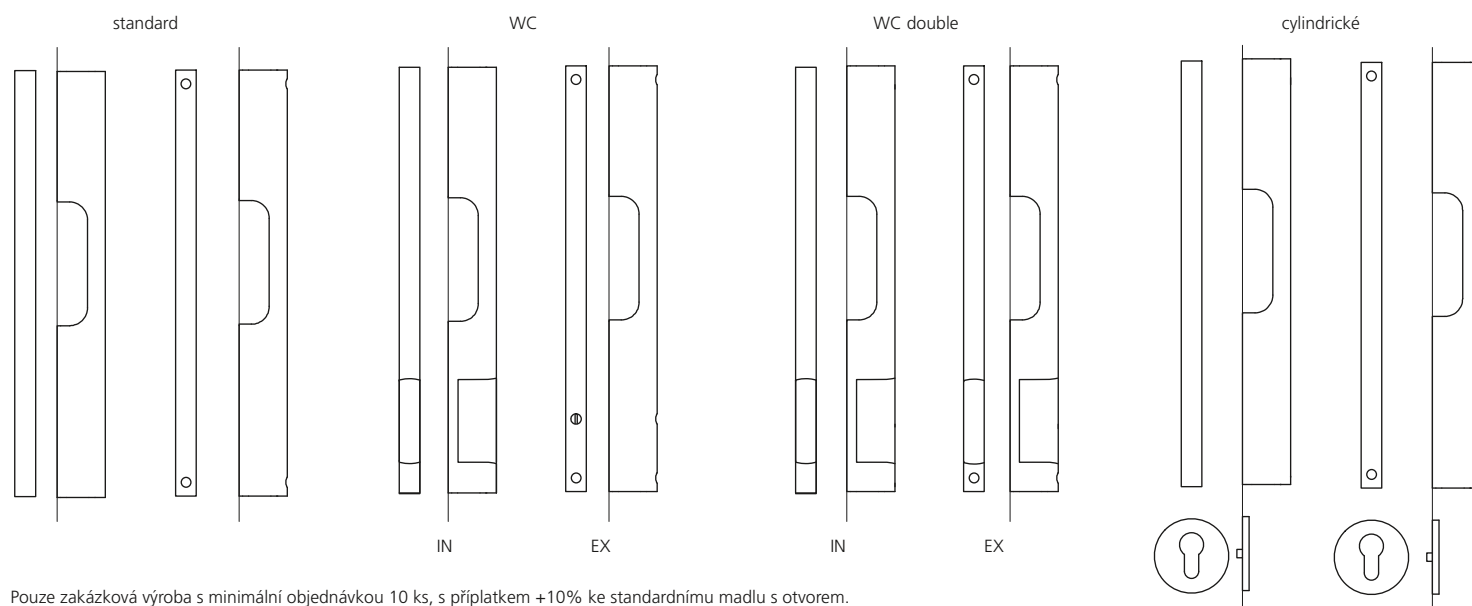

Pouze zakázková výroba s minimální objednávkou 10 ks, s příplatkem +10% ke standardnímu madlu s otvorem.

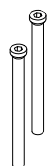

Šrouby k madlu Yes! na dřevěné dveře oboustranné madlo		SNi		Cr		TiN-C		TiN-K		TiN-B		TiN-A	
		cena / sada	EAN	cena / sada	EAN	cena / sada	EAN	cena / sada	EAN	cena / sada	EAN	cena / sada	EAN
tl. dveří	Kč	50,-	124774	50,-	155143	100,-	155211	100,-	155280	100,-	155358	100,-	155426
51 - 60 mm	€	2,1		2,1		4,2		4,2		4,2		4,2	
tl. dveří	Kč	50,-	155082	50,-	155150	100,-	155228	100,-	155297	100,-	155365	100,-	155433
61 - 70 mm	€	2,1		2,1		4,2		4,2		4,2		4,2	
tl. dveří	Kč	50,-	155099	50,-	155167	100,-	155235	100,-	155303	100,-	155372	100,-	155440
71 - 80 mm	€	2,1		2,1		4,2		4,2		4,2		4,2	
tl. dveří	Kč	75,-	155105	75,-	155174	130,-	155242	130,-	155310	130,-	155389	130,-	155457
81 - 90 mm	€	3,2		3,2		5,5		5,5		5,5		5,5	
tl. dveří	Kč	75,-	155112	75,-	155181	130,-	155259	130,-	155327	130,-	155396	130,-	155464
91 - 100 mm	€	3,2		3,2		5,5		5,5		5,5		5,5	
tl. dveří	Kč	75,-	155129	75,-	155198	130,-	155266	130,-	155334	130,-	155402	130,-	155471
101 - 110 mm	€	3,2		3,2		5,5		5,5		5,5		5,5	
tl. dveří	Kč	75,-	155136	75,-	155204	130,-	155273	130,-	155341	130,-	155419	130,-	155488
111 - 120 mm	€	3,2		3,2		5,5		5,5		5,5		5,5	

Šrouby pro tl. dveří 38 - 50 mm jsou v ceně madla a součástí dodávky madel.

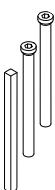

Montážní materiál k madlu Yes! WC		SNi		Cr		TiN-C		TiN-K		TiN-B		TiN-A	
		cena / sada	EAN	cena / sada	EAN	cena / sada	EAN	cena / sada	EAN	cena / sada	EAN	cena / sada	EAN
tl. dveří	Kč	400,-	124781	400,-	155549	500,-	155570	500,-	155600	500,-	155631	500,-	155662
46 - 50 mm	€	17,-		17,-		21,-		21,-		21,-		21,-	
tl. dveří	Kč	400,-	124798	400,-	155556	500,-	155587	500,-	155617	500,-	155648	500,-	155679
51 - 55 mm	€	17,-		17,-		21,-		21,-		21,-		21,-	
tl. dveří	Kč	400,-	124804	400,-	155563	500,-	155594	500,-	155624	500,-	155655	500,-	155686
56 - 60 mm	€	17,-		17,-		21,-		21,-		21,-		21,-	

Montážní materiál pro tl. dveří 38 - 45 mm je v ceně madla a součástí dodávky madel.

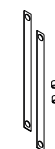

Montážní materiál k madlu Yes! na sklo		SNi		Cr		TiN-C		TiN-K		TiN-B		TiN-A	
		cena / sada	EAN	cena / sada	EAN	cena / sada	EAN	cena / sada	EAN	cena / sada	EAN	cena / sada	EAN
na sklo	Kč	340,-	112511	340,-	155495	450,-	155501	450,-	155518	450,-	155525	450,-	155532
8 - 12 mm	€	15,-		15,-		19,-		19,-		19,-		19,-	



Šrouby k madlu Yes! na dřevěné dveře jednostranné madlo		cena	EAN
		sada	
tl. dveří	Kč	25,-	155068
46 - 55 mm	€	1,1	
tl. dveří	Kč	25,-	155075
56 - 65 mm	€	1,1	

Šrouby pro tl. dveří 38 - 45 mm jsou v ceně madla a součástí dodávky madel.

### Rozměrové varianty madla Yes!

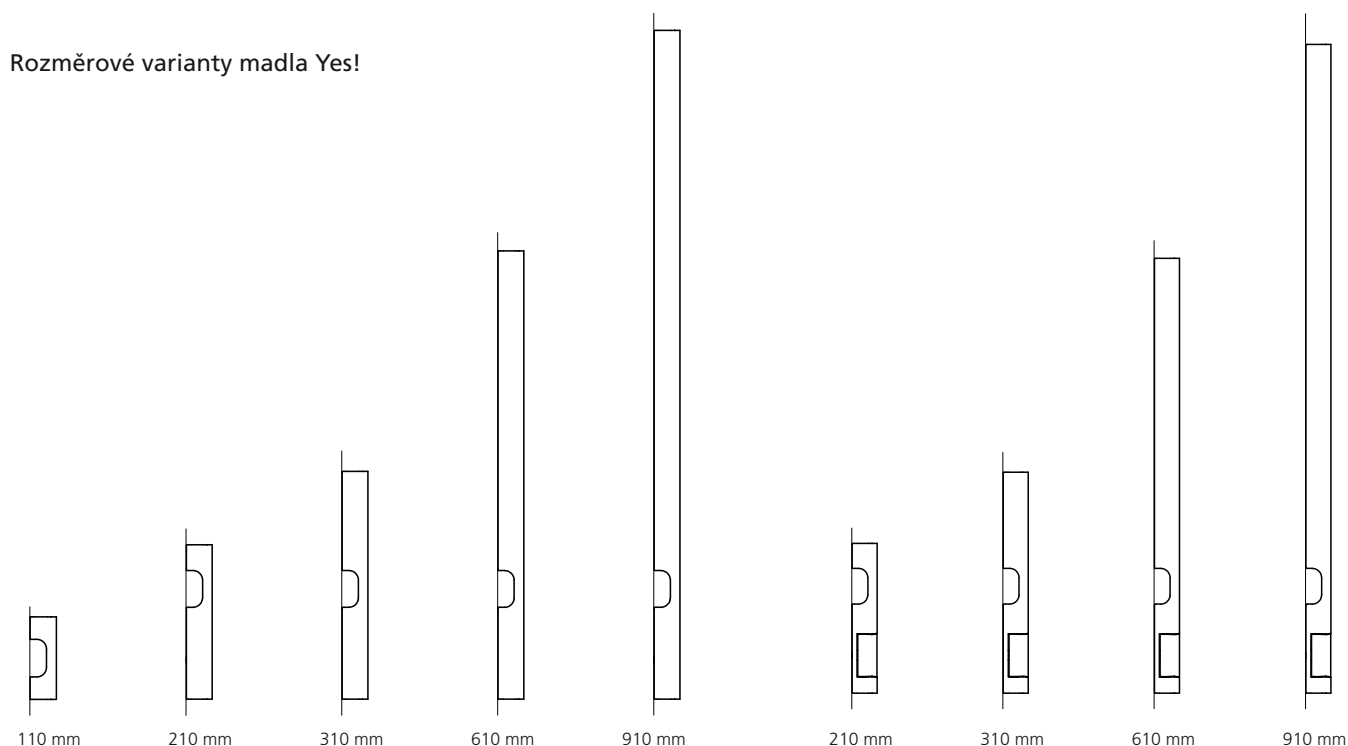

VOLNO





OBSAZENO



Součástí madla YES! je integrované zamykání WC/koupelna, což přináší dosud nepoznaný dojem.

Video na [www.magnetic-mt.cz](http://www.magnetic-mt.cz)



**Madlo Minimal**

14480,- Kč  
 604,- EUR

materiál: masivní mosaz  
 povrch: TiN-K titan černý mat **EUR**

14480,-



604,-



**Madlo Minimal**  
 + zámek + protiplech

16870,- Kč  
 703,- EUR

materiál: masivní mosaz  
 povrch: TiN-K titan černý mat **EUR**

16870,-

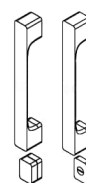

703,-

15770,-

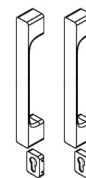

658,-



		TiN-K		Sni		Sni - broušeno		Ms		Ms-L	
		cena / pár	EAN	cena / pár	EAN	cena / pár	EAN	cena / pár	EAN	cena / pár	EAN
oboustranné	Kč €	14480,- 604,-	002751	11560,- 482,-	002706	11890,- 496,-	002713	12260,- 511,-	058819	12260,- 511,-	058833

		Cr		TiN-C		TiN-B		TiN-A	
		cena / pár	EAN	cena / pár	EAN	cena / pár	EAN	cena / pár	EAN
oboustranné	Kč €	12260,- 511,-	002720	14480,- 604,-	002737	14480,- 604,-	002744	14480,- 604,-	002768



		TiN-K / TiN-K		Sni / nerez		Sni - br. / nerez		Ms / TiN-K		Ms-L / TiN-K	
		cena / pár	EAN	cena / pár	EAN	cena / pár	EAN	cena / pár	EAN	cena / pár	EAN
WC	Kč €	16870,- 703,-	112023	13560,- 565,-	111965	13880,- 579,-	111972	14250,- 594,-	111996	14250,- 594,-	112009
cylindrické	Kč €	15770,- 658,-	112115	12750,- 532,-	112054	13090,- 546,-	112061	13710,- 572,-	112085	13710,- 572,-	112092

		Cr / nerez		Cr-K / TiN-K		TiN-C / nerez		TiN-B / TiN-K	
		cena / pár	EAN	cena / pár	EAN	cena / pár	EAN	cena / pár	EAN
WC	Kč €	14250,- 594,-	111989	19570,- 816,-	112047	16870,- 703,-	112016	16870,- 703,-	112030
cylindrické	Kč €	13710,- 572,-	112078	18380,- 766,-	112139	15770,- 658,-	112108	15770,- 658,-	112122

První uvedený povrch je povrch madla a WC mechanismu, druhý za lomítkem je povrch čela zámku a protiplechu.

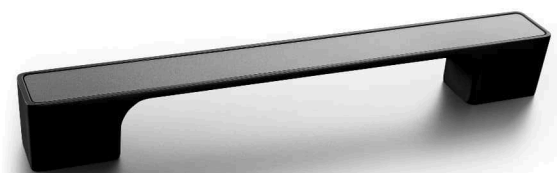

**Madlo Maximal**  
(bez výplně)

14930,- Kč  
623,- EUR

materiál: masivní mosaz + výplň  
Kč povrch: TiN-K titan černý mat EUR

14930,-

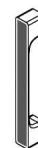

623,-

**Madlo Maximal**  
(bez výplně) + zámek + protipelech

17530,- Kč  
731,- EUR

materiál: masivní mosaz + výplň  
Kč povrch: TiN-K titan černý mat EUR

17530,-

16180,-

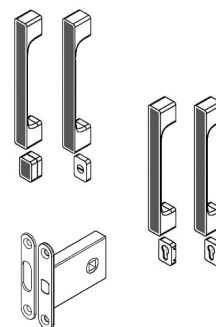

731,-

675,-



**Výplň madla**  
**Maximal**

590,- Kč  
25,- EUR

Kč EUR

590,-

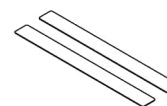

25,-

**Výplň WC**  
**Maximal**

150,- Kč  
6,3 EUR

Kč EUR

150,-



6,3



	TiN-K		SNI		SNI - broušeno		Ms		Ms-L		
	cena / pár	EAN	cena / pár	EAN	cena / pár	EAN	cena / pár	EAN	cena / pár	EAN	
oboustranné	Kč €	14930,- 623,-	002898	11960,- 499,-	002843	12300,- 513,-	002850	12630,- 527,-	058857	12630,- 527,-	058871

	Cr		TiN-C		TiN-B		TiN-A		
	cena / pár	EAN	cena / pár	EAN	cena / pár	EAN	cena / pár	EAN	
oboustranné	Kč €	12630,- 527,-	002867	14930,- 623,-	002874	14930,- 623,-	002881	14930,- 623,-	002904

Výplň do madla není součástí dodávky, objednává se samostatně.



	TiN-K / TiN-K		SNI / nerez		SNI - br. / nerez		Ms / TiN-K		Ms-L / TiN-K		
	cena / pár	EAN	cena / pár	EAN	cena / pár	EAN	cena / pár	EAN	cena / pár	EAN	
WC	Kč €	17530,- 731,-	112207	13950,- 582,-	112146	14280,- 595,-	112153	14710,- 613,-	112177	14710,- 613,-	112184
cyklindrické	Kč €	16180,- 675,-	112283	13150,- 548,-	112221	13360,- 557,-	112238	14050,- 586,-	112252	14050,- 586,-	112269

	Cr / nerez		TiN-C / nerez		TiN-B / TiN-K		
	cena / pár	EAN	cena / pár	EAN	cena / pár	EAN	
WC	Kč €	14710,- 613,-	112160	17530,- 731,-	112191	17530,- 731,-	112214
cyklindrické	Kč €	14050,- 586,-	112245	16180,- 675,-	112276	16180,- 675,-	112290

První uvedený povrch je povrch madla a WC mechanismu, druhý za lomítkem je povrch čela zámku a protiplechu. Výplň do madla a WC není součástí dodávky, objednává se samostatně.

	Bílá matná		Bílá lesklá		Dřevo		Barvy RAL		
	cena / pár	EAN	cena / pár	EAN	cena / pár	EAN	cena / pár	EAN	
	Kč €	590,- 25,-	111804	590,- 25,-	111811	590,- 25,-	002980	730,- 31,-	022520

	Bílá matná		Bílá lesklá		Dřevo		Barvy RAL		
	cena / ks	EAN	cena / ks	EAN	cena / ks	EAN	cena / ks	EAN	
	Kč €	150,- 6,3	111828	150,- 6,3	111835	150,- 6,3	000740	200,- 8,4	022490

**Madlo Mimolimit**  
(bez dřevěné části)

6310,- Kč  
263,- EUR

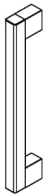

materiál: masivní mosaz  
Kč povrch: TiN-K titan černý mat EUR

6310,-		263,-
7160,-		299,-
9870,-		412,-
10560,-		440,-
14060,-		586,-
17540,-		731,-

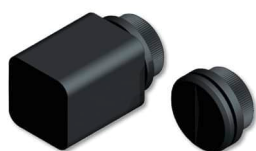

**WC hranaté bezrozetové**  
+ zámek + protiplech (k madlu Mimolimit)

1830,- Kč  
77,- EUR

materiál: masivní mosaz  
Kč povrch: TiN-K titan černý mat EUR

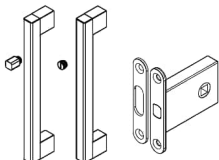
1830,-		77,-
--------	--	------



**Rozety cylindrické**  
+ zámek + protiplech (k madlu Mimolimit)

1720,- Kč  
72,- EUR

materiál: masivní mosaz  
Kč povrch: TiN-K titan černý mat EUR

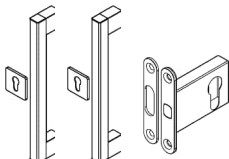
1720,-		72,-
--------	---	------



bělený dub

jilm

teak

**Dřevěná část**  
madla Mimolimit

1180,- Kč  
50,- EUR

Kč EUR

1180,-		50,-
1740,-		73,-
2330,-		98,-
2580,-		108,-
3100,-		130,-
3490,-		146,-



rozteč / délka	TiN-K		SNI - broušeno		Cr		Ms		TiN-C		TiN-B		
	cena / ks	EAN	cena / ks	EAN	cena / ks	EAN	cena / ks	EAN	cena / ks	EAN	cena / ks	EAN	
300 / 340 mm	Kč €	6310,- 263,-	83363	4310,- 180,-	83301	4440,- 185,-	022209	4440,- 185,-	058895	5840,- 244,-	83349	6310,- 263,-	83387
600 / 640 mm	Kč €	7160,- 299,-	83370	5150,- 215,-	83318	5290,- 221,-	022216	5290,- 221,-	058901	6690,- 279,-	83356	7160,- 299,-	83394
900 / 940 mm	Kč €	9870,- 412,-	84056	7560,- 315,-	83974	7700,- 321,-	022223	7700,- 321,-	058918	9400,- 392,-	84018	9870,- 412,-	84094
1200 / 1240 mm	Kč €	10560,- 440,-	84063	8550,- 357,-	83981	8710,- 363,-	022230	8710,- 363,-	058925	10100,- 421,-	84025	10560,- 440,-	84100
1800 / 1840 mm	Kč €	14060,- 586,-	84070	11260,- 470,-	83998	11430,- 477,-	022247	11430,- 477,-	058932	13590,- 567,-	84032	14060,- 586,-	84117
2400 / 2440 mm	Kč €	17540,- 731,-	84087	14140,- 590,-	84001	14280,- 595,-	022254	14280,- 595,-	058949	17070,- 712,-	84049	17540,- 731,-	84124

Dřevěná část madla není součástí dodávky, objednává se samostatně.  
Cena uvedená v tabulce je za 1 ks. Oboustranné madlo jsou 2 ks = pár.



	TiN-K / TiN-K		SNI - br. / nerez		Cr / nerez		Ms / TiN-K		TiN-C / nerez		TiN-B / TiN-K	
	cena / pár	EAN	cena / pár	EAN	cena / pár	EAN	cena / pár	EAN	cena / pár	EAN	cena / pár	EAN
Kč €	1830,- 77,-	108637	1210,- 51,-	111293	1540,- 65,-	110654	1540,- 65,-	112313	1830,- 77,-	112320	1830,- 77,-	112337

První uvedený povrch je povrch WC mechanismu, druhý za lomítkem je povrch čela zámku a protiplechu.



	TiN-K / TiN-K		SNI - br. / nerez		Cr / nerez		Ms / TiN-K		TiN-C / nerez		TiN-B / TiN-K	
	cena / pár	EAN	cena / pár	EAN	cena / pár	EAN	cena / pár	EAN	cena / pár	EAN	cena / pár	EAN
Kč €	1720,- 72,-	112382	1190,- 50,-	112344	1320,- 55,-	112351	1600,- 67,-	112368	1720,- 72,-	112375	1720,- 72,-	112399

První uvedený povrch je povrch WC mechanismu, druhý za lomítkem je povrch čela zámku a protiplechu.

rozteč / délka	Teak		Jilm		Ořech		Dub		Dub bělený		
	cena / ks	EAN	cena / ks	EAN	cena / ks	EAN	cena / ks	EAN	cena / ks	EAN	
300 / 340 mm	Kč €	1180,- 50,-	83400	970,- 41,-	83424	970,- 41,-	83448	970,- 41,-	83936	1080,- 45,-	83950
600 / 640 mm	Kč €	1740,- 73,-	83417	1450,- 61,-	83431	1450,- 61,-	83929	1450,- 61,-	83943	1600,- 67,-	83967
900 / 940 mm	Kč €	2330,- 98,-	84131	1930,- 81,-	84179	1930,- 81,-	84216	1930,- 81,-	84254	2140,- 90,-	84292
1200 / 1240 mm	Kč €	2580,- 108,-	84148	2270,- 95,-	84186	2270,- 95,-	84223	2270,- 95,-	84261	2500,- 105,-	84308
1800 / 1840 mm	Kč €	3100,- 130,-	84155	2580,- 108,-	84193	2580,- 108,-	84230	2580,- 108,-	84278	2840,- 119,-	84315
2400 / 2440 mm	Kč €	3490,- 146,-	84162	2910,- 122,-	84209	2910,- 122,-	84247	2910,- 122,-	84285	3200,- 134,-	84322

Cena uvedená v tabulce je za 1 ks. Oboustranné madlo jsou 2 ks = pár.



**WC bezrozetové**  
+ zámek + protiplech

1830,- Kč  
77,- EUR



materiál: masivní mosaz  
povrch: TiN-K titan černý mat **EUR**

1830,-  77,-

1830,-  77,-



**WC s magnetickou rozetou**  
+ zámek + protiplech

2130,- Kč  
1990,- EUR

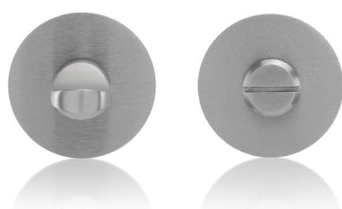

materiál: magnetická nerez ocel  
povrch: TiN-K titan černý mat **EUR**

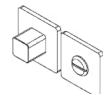
2130,-  89,-

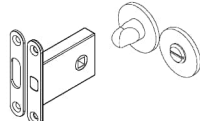
1990,-  83,-



**Magnetické rozety cylindrické**  
+ zámek + protiplech

1190,- Kč  
50,- EUR

materiál: magnetická nerez ocel  
povrch: TiN-K titan černý mat **EUR**

1190,-  50,-

1070,-  45,-

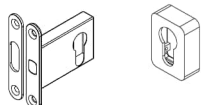
1190,-  50,-

**Protiplech k zámkům Mini**

250,- Kč  
11,- EUR

materiál: magnetická nerez ocel  
povrch: NRz nerez broušeno **EUR**

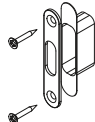
250,-  11,-



		TiN-K / TiN-K		SNI / nerez		Cr / nerez	
		cena / set	EAN	cena / set	EAN	cena / set	EAN
hranaté	Kč €	1830,- 77,-	108637	1210,- 51,-	109382	1540,- 65,-	110654
kulaté	Kč €	1830,- 77,-	110777	1210,- 51,-	110753	1540,- 65,-	110760

První uvedený povrch je povrch WC mechanismu, druhý za lomítkem je povrch čela zámku a protiplechu.

		TiN-K / TiN-K		SNI / nerez		Cr / nerez	
		cena / set	EAN	cena / set	EAN	cena / set	EAN
hranaté	Kč €	2130,- 89,-	112467	1610,- 68,-	112443	1860,- 78,-	112450
kulaté	Kč €	1990,- 83,-	112498	1460,- 61,-	112474	1730,- 73,-	112481

První uvedený povrch je povrch WC mechanismu, druhý za lomítkem je povrch čela zámku a protiplechu.

		SNI / nerez		Cr / nerez		TiN-K / TiN-K	
		cena / set	EAN	cena / set	EAN	cena / set	EAN
hranaté	Kč €	1190,- 50,-	112504	1320,- 55,-	112351	1720,- 72,-	112382
kulaté	Kč €	1070,- 45,-	112535	1180,- 50,-	112542	1440,- 60,-	112559
obdélníkové 33 x 47 mm	Kč €	1190,- 50,-	112566	1320,- 55,-	112573	1600,- 67,-	112580

První uvedený povrch je povrch WC mechanismu, druhý za lomítkem je povrch čela zámku a protiplechu.

**Poznámky:**

Čela zámků (WC, cylindrický) a protiplechu se dodávají standardně podle povrchů uvedených výše v tabulkách. Dále je možné dodat na základě požadavku bílé provedení čel zámků a protiplechu pro sjednocení bílého povrchu s provedením povrchu Magnetica a Magnetického bloku. Bílé provedení na zámcích je bez dalšího příplatku.

		NRz		Černá matná	
		cena / set	EAN	cena / set	EAN
	Kč €	250,- 11,-	141429	370,- 16,-	141436



Příbuzný sortiment

Kování pro hliníkové a ocelové dveře,  
kování na branky



Rozetové kování



Okenní kliky 225, 250 mm / HS Portaly  
na posuvná okna a stěny



Madla dlouhá

## Okenní kliky 3 a 4 polohové

Okenní kliky M&T doplňují kolekci dveřních klik vždy ve stejném designu a povrchové úpravě. Tím lze každý projekt, každou realizaci perfektně sladit v jeden celek. Vyberte si dveřní kliky z některé z designových řad a ve stejné designové řadě naleznete i okenní kliky odpovídajícího tvaru a barevného odstínu. Nabídka, kterou nenaleznete u žádné jiné firmy na trhu. Pro požadovanou funkčnost jsou ke kování připraveny 3 typy polohovacích mechanismů, kdy každý se vyznačuje svými přednostmi odpovídající materiálu a použití. Polohovací mechanismy jsou univerzální pro všechny typy okenních klik M&T, stačí jen zvolit požadovanou variantu podle specifických požadavků na funkčnost.

Materiál: **masivní mosaz**

Povrchy: **SNi, SNi – broušeno, Cr, TiN-C, TiN-K, TiN-B, Ms, Ms-A, Ms-L, zakázkově TiN-S, TiN-A**  
více info na [www.kliky-mt.cz/manufaktura/barvy-povrchy](http://www.kliky-mt.cz/manufaktura/barvy-povrchy)

Materiál: **nerezová ocel**

Povrchy: **NRz, TiN-K, K-industrial**

**MINIMAL Cr** lesklý chrom

**ENTERO NRz** nerez -broušeno



uzamykatelný polohovací mechanismus

Kovový uzamykatelný mechanismus s vnitřní ocelovou konstrukcí a mosazným krytem. Univerzální mechanismus pro všechny typy okenních klik M&T. Dodáváme ve více povrchových úpravách viz. str. 263. Mechanismus je 3-polohový tzn. polohy po 90°, opatřen vyjímatelným klíčem. Standardní délka čtyřhranu 7x7 do rámu okna je 42 mm. Montáž identická jako u ostatních okenních mechanismů M&T.

polohovací mechanismus plastový

Plastový mechanismus s vnitřní plastovou konstrukcí, zaručující velmi tichý chod i po dlouhodobém používání, nevýhodou je vakl mezi okenní klikou a mechanismem způsobený vlastností plastu (pružnost).

polohovací mechanismus kovový

Kovový mechanismus s vnitřní celokovovou konstrukcí, zaručující přesnou polohovatelnost a pevnou fixaci okenní kliky v mechanismu, nevýhodou je hlučnější chod při dlouhodobém používání (nutnost pravidelné údržby).

Doporučujeme objednávat kovový.

konstrukční varianty, materiálové provedení

- polohovací mechanismus standardně se čtyřhranem 7x7 mm do rámu okna dodáváme v délce 37 mm
- další délky čtyřhranu 7x7 mm: 32, 42, 50 a 61 mm (požadovaný rozměr je třeba uvádět do objednávky)
- krycí rozety k polohovacímu mechanismu jsou v různých tvarových provedeních podle zvolené designové řady okenní kliky
- polohovací mechanismy jsou univerzální tj. 3 i 4 polohové, tzn. polohy po 90° nebo 45°
- polohovací mechanismy jsou plastové nebo kovové se specifikací výše
- záruka 3 roky, NRz 5 let, titany 15 let

roky **3 garance** let **5 garance** let **15 garance**



kovový mechanismus 37 mm  
EAN 119770 cena 150,- Kč / 6,3 EUR

kovový mechanismus 42 mm  
EAN 119787 cena 150,- Kč / 6,3 EUR

kovový mechanismus 50 mm  
EAN 119794 cena 160,- Kč / 6,7 EUR

kovový mechanismus 61 mm  
EAN 119800 cena 180,- Kč / 7,5 EUR

**Okenní kliky Nerez**

materiál: nerezová ocel  
 povrch: NRz nerez - broušeno

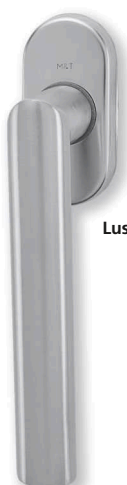

Lusy



Deny



Meclis



Morgan



Jameson



Senza

NRz nerez - broušeno



Nova



Promo



Entero



Kvadra



Techno

TiN-K titan černý mat



Morgan



NRz nerez - broušeno



Lusy



Cesan

**Okenní kliky DESIGN 2012 ploché rozety**

materiál: nerezová ocel  
 povrch: NRz nerez - broušeno

		NRz		TiN-K		K-industrial	
		cena / ks	EAN	cena / ks	EAN	cena / ks	EAN
Lusy	Kč €	360,- 15,-	80232	950,- 40,-	023978	950,- 40,-	033847
Deny	Kč €	360,- 15,-	80249	950,- 40,-	023985	950,- 40,-	033854
Meclis	Kč €	450,- 19,-	023893	1040,- 44,-	023992	1040,- 44,-	033861
Morgan	Kč €	450,- 19,-	80225	1040,- 44,-	024005	1040,- 44,-	033878
Jameson	Kč €	540,- 23,-	023909	1110,- 47,-	024012	1110,- 47,-	033885
Senza	Kč €	720,- 30,-	023923			1300,- 55,-	033892
Nova	Kč €	720,- 30,-	023916	1300,- 55,-	024029	1300,- 55,-	033908
Promo	Kč €	800,- 34,-	023930			1390,- 58,-	033915
Entero	Kč €	800,- 34,-	80218	1390,- 58,-	024050	1390,- 58,-	033922
Kvadra	Kč €	800,- 34,-	023947	1390,- 58,-	024067	1390,- 58,-	033939
Techno	Kč €	720,- 30,-	023954			1300,- 55,-	033946
Cesan	Kč €	620,- 26,-	023961	1210,- 51,-	024081	1210,- 51,-	033953
Sonia	Kč €	620,- 26,-	120813	1210,- 51,-	120820	1210,- 51,-	137767

Polohovací mechanismus není součástí okenní kliky a lze zvolit mechanismus plastový EAN 90309 ... 58 Kč/ks nebo kovový EAN 119770... 150 Kč/ks podle požadavku na funkčnost, viz. předchozí strana.

		NRz		TiN-K		K-industrial	
		cena / ks	EAN	cena / ks	EAN	cena / ks	EAN
Morgan							
oválná rozeta	Kč €	830,- 35,-	48638	1330,- 56,-	48645	1330,- 56,-	033984
obdélníková rozeta	Kč €	890,- 38,-	48423	1390,- 58,-	48430	1390,- 58,-	033991
Lusy							
oválná rozeta	Kč €	700,- 30,-	48614	1280,- 54,-	48621	1280,- 54,-	034004
obdélníková rozeta	Kč €	760,- 32,-	48263	1330,- 56,-	48287	1330,- 56,-	034011
Entero							
oválná rozeta	Kč €	830,- 35,-	48591	1430,- 60,-	48607	1430,- 60,-	033960
obdélníková rozeta	Kč €	890,- 38,-	48201	1480,- 62,-	48218	1480,- 62,-	033977
Cesan							
oválná rozeta	Kč €	760,- 32,-	48461	1330,- 56,-	48478	1330,- 56,-	034028

Polohovací mechanismus s plochou rozetou je 3-polohový kovový a je součástí příslušenství okenní kliky.  
\* Povrch TiN-K je s rukojetí Entero, nelze dodat s rukojetí Entero II.

**Okenní kliky DESIGN 2000, 2004**

materiál: masivní mosaz  
 povrch: SNI matný nikl



Lara

Ms mosaz natural



Cherez

Ms-L mosaz leštěno



Fábi



uzamykatelný mechanismus



Garanti



Andy



Cesan

Cr lesklý chrom



Lusy

TiN-C titan chrom mat



Entero

TiN-K titan černý mat



Deny



Maty



Meclis



Sogut

SNI matný nikl



Mondeo



Burak



Mia



Kemer



		SNI		Cr		Ms		Ms-L		TiN-C		TiN-K	
		cena / ks	EAN	cena / ks	EAN	cena / ks	EAN	cena / ks	EAN	cena / ks	EAN	cena / ks	EAN
uzamykatelný mechanismus	Kč €	1840,- 77,-	080704	1980,- 83,-	080728	1980,- 83,-	080735	1980,- 83,-	080742	2400,- 100,-	080759	2400,- 100,-	080766
Lara	Kč €	1710,- 72,-	70592	1850,- 78,-	70615	1850,- 78,-	059014	1850,- 78,-	059229	2320,- 97,-	70653	2320,- 97,-	70677
Cherez	Kč €	1540,- 65,-	70714	1710,- 72,-	70738	1710,- 72,-	059021	1710,- 72,-	059236	2170,- 91,-	70776	2170,- 91,-	70790
Fábi	Kč €	1240,- 52,-	36741	1390,- 58,-	36758	1390,- 58,-	059038	1390,- 58,-	059243	1850,- 78,-	36772	1850,- 78,-	36789
Garanti	Kč €	920,- 39,-	36208	1080,- 45,-	36215	1080,- 45,-	059045	1080,- 45,-	059250	1540,- 65,-	36239	1540,- 65,-	36246
Andy	Kč €	1080,- 45,-	36567	1240,- 52,-	36574	1240,- 52,-	059052	1240,- 52,-	059267	1710,- 72,-	36598	1710,- 72,-	36604
Cesan	Kč €	920,- 39,-	36260	1080,- 45,-	36277	1080,- 45,-	059069	1080,- 45,-	059274	1540,- 65,-	36291	1540,- 65,-	36307
Lusy	Kč €	1080,- 45,-	36987	1240,- 52,-	36994	1240,- 52,-	059076	1240,- 52,-	059281	1710,- 72,-	37014	1710,- 72,-	37021
Entero	Kč €	1850,- 78,-	70479	2010,- 84,-	70493	2010,- 84,-	059083	2010,- 84,-	059298	2480,- 104,-	70530	2480,- 104,-	70554
Deny	Kč €	1080,- 45,-	37045	1240,- 52,-	37052	1240,- 52,-	059090	1240,- 52,-	059304	1710,- 72,-	37076	1710,- 72,-	37083
Maty	Kč €	1390,- 58,-	37106	1540,- 65,-	37113	1540,- 65,-	059106	1540,- 65,-	059311	2010,- 84,-	37137	2010,- 84,-	37144
Meclis	Kč €	1080,- 45,-	36925	1240,- 52,-	36932	1240,- 52,-	059113	1240,- 52,-	059328	1710,- 72,-	36956	1710,- 72,-	36963
Sogut	Kč €	1240,- 52,-	36628	1390,- 58,-	36635	1390,- 58,-	059120	1390,- 58,-	059335	1850,- 78,-	36659	1850,- 78,-	36666
L	Kč €	1240,- 52,-	36680	1390,- 58,-	36697	1390,- 58,-	059137	1390,- 58,-	059342	1850,- 78,-	36710	1850,- 78,-	36727
Mondeo	Kč €	1390,- 58,-	37168	1540,- 65,-	37175	1540,- 65,-	059144	1540,- 65,-	059359	2010,- 84,-	37199	2010,- 84,-	37205
L	Kč €	1390,- 58,-	37229	1540,- 65,-	37236	1540,- 65,-	059151	1540,- 65,-	059366	2010,- 84,-	37250	2010,- 84,-	37267
Burak	Kč €	1080,- 45,-	36321	1240,- 52,-	36338	1240,- 52,-	059168	1240,- 52,-	059373	1710,- 72,-	36352	1710,- 72,-	36369
L	Kč €	1080,- 45,-	36383	1240,- 52,-	36390	1240,- 52,-	059175	1240,- 52,-	059380	1710,- 72,-	36413	1710,- 72,-	36420
Mia	Kč €	1080,- 45,-	36802	1240,- 52,-	36819	1240,- 52,-	059182	1240,- 52,-	059397	1710,- 72,-	36833	1710,- 72,-	36840
L	Kč €	1080,- 45,-	36864	1240,- 52,-	36871	1240,- 52,-	059199	1240,- 52,-	059403	1710,- 72,-	36895	1710,- 72,-	36901
Kemer	Kč €	1240,- 52,-	36444	1390,- 58,-	36451	1390,- 58,-	059205	1390,- 58,-	059410	1850,- 78,-	36475	1850,- 78,-	36482
L	Kč €	1240,- 52,-	36505	1390,- 58,-	36512	1390,- 58,-	059212	1390,- 58,-	059427	1850,- 78,-	36536	1850,- 78,-	36543



Entry

SNi matný nikl - broušeno



Trinity

TiN-C titan chrom mat



My



Terry



Tukan

SNi matný nikl - broušeno



Maya



Toro



Mimolimit

TiN-B titan braun mat



Mini-V

SNi matný nikl



Mini-C



Mini-S



Mini-T

TiN-K titan černý mat



Minimal



Maximal

SNi matný nikl  
vyplň dřevo - dýha teak



Minimal  
zapuštěná



Maximal  
zapuštěná

### Okenní kliky DESIGN 2006

materiál: masivní mosaz  
Kč povrch: SNi matný nikl - broušeno EUR

2330,-	98,-
2030,-	85,-
2180,-	91,-
2180,-	91,-

### Okenní kliky DESIGN 2009

materiál: masivní mosaz  
Kč povrch: SNi matný nikl - broušeno EUR

2350,-	98,-
2500,-	105,-
2350,-	98,-
2350,-	98,-

### Okenní kliky DESIGN 2011

materiál: masivní mosaz  
Kč povrch: SNi matný nikl EUR

1250,-	53,-
1250,-	53,-
1250,-	53,-
1250,-	53,-

### Okenní kliky Minimal / Maximal

materiál: masivní mosaz  
Kč povrch: SNi matný nikl EUR

2570,-	108,-
2790,-	117,-
2880,-	120,-
3110,-	130,-

u zapuštěné okenní kliky Minimal, Maximal je polohovací mechanismus 3-polohový a je přímo součástí kliky





		SNI - broušeno		Cr		Ms		Ms-L		TiN-C		TiN-K	
		cena / ks	EAN	cena / ks	EAN	cena / ks	EAN	cena / ks	EAN	cena / ks	EAN	cena / ks	EAN
Entry	Kč €	2330,- 98,-	77881	2490,- 104,-	77904	2490,- 104,-	059434	2490,- 104,-	059472	2960,- 124,-	77942	2960,- 124,-	77966
Trinity	Kč €	2030,- 85,-	78000	2180,- 91,-	78024	2180,- 91,-	059441	2180,- 91,-	059489	2650,- 111,-	78062	2650,- 111,-	78086
My	Kč €	2180,- 91,-	78123	2330,- 98,-	78147	2330,- 98,-	059458	2330,- 98,-	059496	2790,- 117,-	78185	2790,- 117,-	78208
Terry	Kč €	2180,- 91,-	78246	2330,- 98,-	78260	2330,- 98,-	059465	2330,- 98,-	059502	2790,- 117,-	78307	2790,- 117,-	78321

		SNI - broušeno		Cr		Ms		TiN-C		TiN-K		TiN-B	
		cena / ks	EAN	cena / ks	EAN	cena / ks	EAN	cena / ks	EAN	cena / ks	EAN	cena / ks	EAN
Tukan	Kč €	2350,- 98,-	28012	2500,- 105,-	022063	2500,- 105,-	059519	2970,- 124,-	28029			2970,- 124,-	28036
Maya	Kč €	2500,- 105,-	28067	2660,- 111,-	022100	2660,- 111,-	059526	3130,- 131,-	28074			3130,- 131,-	28081
Toro	Kč €	2350,- 98,-	28098	2500,- 105,-	022148	2500,- 105,-	059533	2970,- 124,-	28104			2970,- 124,-	28197
Mimolimit	pravá levá Kč €	2350,- 98,-	28203 85718	2500,- 105,-	022186 022193	2500,- 105,-	059540 059557	2970,- 124,-	28210 85770	2970,- 124,-	28227 85831	2970,- 124,-	28234 85893



		SNI		Cr		Ms		Ms-L		TiN-K	
		cena / ks	EAN	cena / ks	EAN	cena / ks	EAN	cena / ks	EAN	cena / ks	EAN
Mini-V	Kč €	1250,- 53,-	86289	1490,- 63,-	86333	1490,- 63,-	059618	1490,- 63,-	059656	1860,- 78,-	86388
Mini-C	Kč €	1250,- 53,-	86432	1490,- 63,-	86487	1490,- 63,-	059625	1490,- 63,-	059663	1860,- 78,-	86531
Mini-S	Kč €	1250,- 53,-	86586	1490,- 63,-	86630	1490,- 63,-	059632	1490,- 63,-	059670	1860,- 78,-	86685
Mini-T	Kč €	1250,- 53,-	86739	1490,- 63,-	86784	1490,- 63,-	059649	1490,- 63,-	059687	1860,- 78,-	86838

Polohovací mechanismus není součástí okenní kliky a lze zvolit mechanismus kovový EAN 119770... 150 Kč/ks podle požadavku na funkčnost, viz. strana 259.

		SNI		SNI - broušeno		Cr		Ms		TiN-C		TiN-B		TiN-K	
		cena / ks	EAN	cena / ks	EAN	cena / ks	EAN	cena / ks	EAN	cena / ks	EAN	cena / ks	EAN	cena / ks	EAN
Minimal	Kč €	2570,- 108,-	001815	2640,- 110,-	001822	2740,- 115,-	001839	2740,- 115,-	059694	3200,- 134,-	001846	3200,- 134,-	001853	3200,- 134,-	001860
Minimal zapuštěná	Kč €	2790,- 117,-	071085	2860,- 120,-	071092	2960,- 124,-	071108	2960,- 124,-	071115	3420,- 143,-	071139	3420,- 143,-	071153	3420,- 143,-	071146
Maximal	Kč €	2880,- 120,-	001884	2950,- 123,-	001891	3030,- 127,-	001907	2650,- 111,-	059700	3500,- 146,-	001914	3500,- 146,-	001921	3500,- 146,-	001938
Maximal zapuštěná	Kč €	3110,- 130,-	071177	3190,- 133,-	071184	3260,- 136,-	071191	3260,- 136,-	071207	3720,- 155,-	071221	3720,- 155,-	071245	3720,- 155,-	071238

specifikace výplně kliky Maximal, cena, EAN na str. 109, „výplň kliky Maximal“



Příbuzný sortiment

Rozetové kování



Kování pro hliníkové a ocelové dveře,  
kování na branky



Mušle na posuvné  
dveře



Okenní kliky  
3 a 4 polohové



Magnetické zámky



Madla dlouhá



## Okenní kliky 225, 250 mm / HS Portaly na posuvná okna a stěny

Materiál: nerez ocel, masivní mosaz   
 Povrchy: SNI, Cr, SNI-broušeno, TiN-C, TiN-B, TiN-K, Ms, Ms-L, zakázkově TiN-A, NRZ, K-industrial  
 více info na [www.kliky-mt.cz/manufaktura/barvy-povrchy](http://www.kliky-mt.cz/manufaktura/barvy-povrchy)

Kování M&T v systému HS Portal je reakcí na požadavky zákazníku vyžadujících tu nejvyšší kvalitu a mimořádný design na ovládacích klikách u velkoplošných oken a prosklených stěn, které patří k dominantám projektů. Aby tomu tak bylo, jsou připraveny splnit designové řady Minimal / Maximal a Mimolimit ve všech variantách povrchových úprav včetně titanových povrchů i ty nejnáročnější požadavky architektů a investorů dokonalých staveb.

### MINIMAL

TiN-K titan černý mat



### MIMOLIMIT

SNI matný nikl + masivní ořech



### ENTERO

TiN-K titan černý mat



### LUSY

NRZ nerez-broušeno

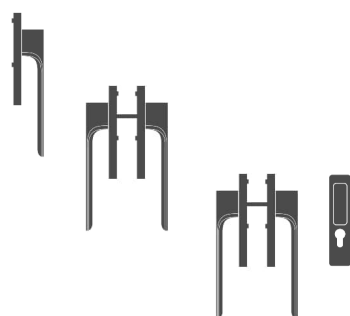

Klika jednostranná

Klika oboustranná

Klika oboustranná s cylindrickým otvorem

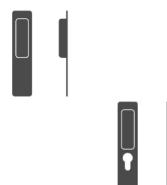

Mušle venkovní

Mušle venkovní s cylindrickým otvorem

#### konstrukční varianty, materiálové provedení

- konstrukčně a montážně připraveno pro systém HS Portal
- montáž na tl. rámu 55 – 120 mm, montážní materiál je třeba specifikovat podle tloušťky rámu
- rukojeť vyrobena z masivní mosazi
- délka rukojeti Minimal, Lusy 225 mm
- délka rukojeti Mimolimit, Entero 250 mm
- krycí štít vyroben z masivní mosazi
- vysokopevnostní ovládací trn/čtyřhran z nerez oceli 10x10 mm
- záruka 3 roky, titány 15 let

roky **3** garance    let **15** garance

#### Ochranné známky – registrované značky



**MINIMAL®**  
**MAXIMAL®**  
**MIMOLIMIT®**

#### Chráněné průmyslové vzory klik



**MINIMAL**  
**MIMOLIMIT**



TiN-C titan chrom mat



SNI matný nikl



TiN-K titan černý mat



Ms mosaz natural

**Klika 225 mm Minimal**  
k dveřním systémům HS portal

6650,- Kč  
278,- EUR

Kč	materiál: masivní mosaz povrch: SNI matný nikl	EUR
6650,-		278,-
6720,-		280,-
13270,-		553,-
13400,-		559,-



MAXIMAL SNI matný nikl  
výplň dřevo teak

**Klika 225 mm Maximal**  
k dveřním systémům HS portal

6950,- Kč  
290,- EUR

Kč	materiál: masivní mosaz povrch: SNI matný nikl	EUR
6950,-		290,-
6990,-		292,-
13860,-		578,-
13970,-		583,-

**Výplň kliky 225 mm  
Maximal**

590,- Kč  
25,- EUR





	SNI		SNI - broušeno		Cr		Ms		TiN-C		TiN-B		TiN-K		
	cena	EAN	cena	EAN	cena	EAN	cena	EAN	cena	EAN	cena	EAN	cena	EAN	
jednostranná*	Kč €	ks 6650,- 278,-	001990	ks 6870,- 287,-	002003	ks 7040,- 294,-	002010	ks 7040,- 294,-	059731	ks 8200,- 342,-	002027	ks 8200,- 342,-	002034	ks 8200,- 342,-	002041
jednostranná s cylindr. otvorem*	Kč €	ks 6720,- 280,-	064698	ks 6940,- 290,-	064704	ks 7090,- 296,-	064711	ks 7090,- 296,-	064766	ks 8290,- 346,-	064728	ks 8290,- 346,-	064735	ks 8290,- 346,-	064742
oboustranná	Kč €	pár 13270,- 553,-	002065	pár 13710,- 572,-	002072	pár 14050,- 586,-	002089	pár 14050,- 586,-	059748	pár 16390,- 683,-	002096	pár 16390,- 683,-	002102	pár 16390,- 683,-	002119
oboustranná s cylindr. otvorem	Kč €	pár 13400,- 559,-	002133	pár 13830,- 577,-	002140	pár 14170,- 591,-	002157	pár 14170,- 591,-	059755	pár 16500,- 688,-	002164	pár 16500,- 688,-	002171	pár 16500,- 688,-	002188

\* Nutno upřesnit přesnou délku montážních šroubů a čtyřhranu.



	SNI		SNI - broušeno		Cr		Ms		TiN-C		TiN-B		TiN-K		
	cena	EAN	cena	EAN	cena	EAN	cena	EAN	cena	EAN	cena	EAN	cena	EAN	
jednostranná*	Kč €	ks 6950,- 290,-	002270	ks 7160,- 299,-	002287	ks 7350,- 307,-	002294	ks 7350,- 307,-	059793	ks 8510,- 355,-	002300	ks 8510,- 355,-	002317	ks 8510,- 355,-	002324
jednostranná s cylindr. otvorem*	Kč €	ks 6990,- 292,-	064780	ks 7220,- 301,-	064797	ks 7400,- 309,-	064803	ks 7400,- 309,-	064858	ks 8550,- 357,-	064810	ks 8550,- 357,-	064827	ks 8550,- 357,-	064834
oboustranná	Kč €	pár 13860,- 578,-	002348	pár 14280,- 595,-	002355	pár 14630,- 610,-	002362	pár 14630,- 610,-	059809	pár 16970,- 708,-	002379	pár 16970,- 708,-	002386	pár 16970,- 708,-	002393
oboustranná s cylindr. otvorem	Kč €	pár 13970,- 583,-	002416	pár 14410,- 601,-	002423	pár 14740,- 615,-	002430	pár 14740,- 615,-	059816	pár 17070,- 712,-	002447	pár 17070,- 712,-	002454	pár 17070,- 712,-	002461

	cena	EAN
	ks	
dřevo	Kč € 590,- 25,-	002485
kov	Kč € 590,- 25,-	002492
kůže	Kč € 700,- 30,-	002508
„sklo“	Kč € 700,- 30,-	002515
RAL barvy	Kč € 730,- 31,-	022513

\* Nutno upřesnit přesnou délku montážních šroubů a čtyřhranu.



**SNi** matný nikl + masivní ořech



**TiN-K** titan černý mat + mořený dub

**Klika 250 mm Mimolimit**  
k dveřním systémům HS portal

5070,- Kč  
212,- EUR

**Dřevěná část rukojeti**  
250 mm

1290,- Kč  
54,- EUR

materiál: masivní mosaz  
Kč povrch: SNi matný nikl - broušeno EUR

5070,-		212,-
5120,-		214,-
10100,-		421,-
10230,-		427,-



**TiN-C** titan chrom mat



**TiN-K** titan černý mat



**SNi** matný nikl

**Mušle Minimal venkovní**  
k dveřním systémům HS portal

2800,- Kč  
117,- EUR



**Ms** mosaz natural

materiál: masivní mosaz  
Kč povrch: SNi matný nikl EUR

2800,-		117,-
2880,-		120,-



		SNI - broušeno		Cr		Ms		Ms-L		TiN-C		TiN-B		TiN-K	
		cena	EAN	cena	EAN	cena	EAN	cena	EAN	cena	EAN	cena	EAN	cena	EAN
jednostranná	Kč €	ks 5070,- 212,-	026108	ks 5410,- 226,-	026115	ks 5410,- 226,-	059854	ks 5410,- 226,-	059885	ks 6210,- 259,-	026122	ks 6520,- 272,-	026139	ks 6520,- 272,-	026146
jednostranná s cylindrickým otvorem	Kč €	ks 5120,- 214,-	064872	ks 5490,- 229,-	064889	ks 5490,- 229,-	064926	ks 5490,- 229,-	064933	ks 6280,- 262,-	064896	ks 6580,- 275,-	064902	ks 6580,- 275,-	064919
oboustranná	Kč €	pár 10100,- 421,-	026153	pár 10810,- 451,-	026160	pár 10810,- 451,-	059861	pár 10810,- 451,-	059892	pár 12390,- 517,-	026177	pár 13020,- 543,-	026184	pár 13020,- 543,-	026191
oboustranná s cylindrickým otvorem	Kč €	pár 10230,- 427,-	028478	pár 10950,- 457,-	028485	pár 10950,- 457,-	059878	pár 10950,- 457,-	059908	pár 12530,- 523,-	028492	pár 13140,- 548,-	028508	pár 13140,- 548,-	028515

		Teak		Jilm		Ořech		Dub		Bělený dub	
		cena / ks	EAN	cena / ks	EAN	cena / ks	EAN	cena / ks	EAN	cena / ks	EAN
	Kč €	1290,- 54,-	026207	1180,- 50,-	026214	1180,- 50,-	026221	1180,- 50,-	026238	1290,- 54,-	026245

Zakázkově lze rukojeť dodat v dalších dřevinách.



		SNI		SNI - broušeno		Cr		Ms		TiN-C		TiN-B		TiN-K	
		cena	EAN	cena	EAN	cena	EAN	cena	EAN	cena	EAN	cena	EAN	cena	EAN
mušle venkovní	Kč €	ks 2800,- 117,-	002201	ks 2930,- 123,-	002218	ks 3030,- 127,-	002225	ks 3030,- 127,-	059915	ks 3300,- 138,-	002232	ks 3300,- 138,-	002249	ks 3300,- 138,-	002256
mušle venk. s cylindr. otvorem	Kč €	ks 2880,- 120,-	022544	ks 2980,- 125,-	022551	ks 3110,- 130,-	022568	ks 3110,- 130,-	059922	ks 3410,- 143,-	022575	ks 3410,- 143,-	022582	ks 3410,- 143,-	022599

Vzhledem k technologickému omezení upozorňujeme na odlišný povrch a odlišný barevný odstín uvnitř v úchopné části mušle oproti ostatní pohledové ploše. Standardní provedení si odsouhlasíte podle referenčního vzorku.



NRz nerez - broušeno



TiN-K titan černá mat

**Klika 225 mm Lusy**  
k dveřním systémům HS portal

2790,- Kč  
117,- EUR

materiál: nerezová ocel  
Kč povrch: NRz nerez - broušeno EUR

2790,-		117,-
2860,-		120,-
5580,-		233,-
5690,-		238,-

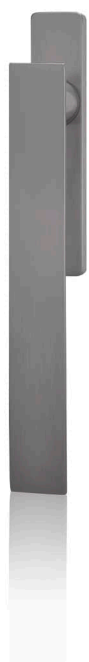

**Klika 250 mm Entero**  
k dveřním systémům HS portal

4260,- Kč  
178,- EUR

materiál: nerezová ocel  
Kč povrch: NRz nerez - broušeno EUR

4260,-		178,-
4330,-		181,-
8510,-		355,-
8620,-		360,-



**Mušle venkovní**

980,- Kč  
41,- EUR

materiál: nerezová ocel  
Kč povrch: NRz nerez - broušeno EUR

980,-		41,-
1020,-		43,-



		NRz		TiN-K		K-industrial	
		cena	EAN	cena	EAN	cena	EAN
jednostranná*	Kč €	ks 2790,- 117,-	064216	ks 4120,- 172,-	064254	ks 4120,- 172,-	142792
jednostranná s cylindr. otvorem*	Kč €	ks 2860,- 120,-	064940	ks 4170,- 174,-	064957	ks 4170,- 174,-	142822
oboustranná	Kč €	pár 5580,- 233,-	064223	pár 8200,- 342,-	064261	pár 8200,- 342,-	142808
oboustranná s cylindr. otvorem	Kč €	pár 5690,- 238,-	064230	pár 8330,- 348,-	064278	pár 8330,- 348,-	142815

\* Při montáži bez venkovní mušle nutno upřesnit přesnou délku montážních šroubů a čtyřhranu.

		NRz		TiN-K		K-industrial	
		cena	EAN	cena	EAN	cena	EAN
jednostranná*	Kč €	ks 4260,- 178,-	064247	ks 5580,- 233,-	064285	ks 5580,- 233,-	144260
jednostranná s cylindr. otvorem*	Kč €	ks 4330,- 181,-	064964	ks 5640,- 235,-	064971	ks 5640,- 235,-	144291
oboustranná	Kč €	pár 8510,- 355,-	064292	pár 11140,- 465,-	064339	pár 11140,- 465,-	144277
oboustranná s cylindr. otvorem	Kč €	pár 8620,- 360,-	064308	pár 11250,- 469,-	064346	pár 11250,- 469,-	144284

\* Nutno upřesnit přesnou délku montážních šroubů a čtyřhranu.

		NRz		TiN-K		K-industrial	
		cena / ks	EAN	cena / ks	EAN	cena / ks	EAN
mušle venkovní	Kč €	980,- 41,-	064315	1420,- 60,-	064353	1420,- 60,-	142839
mušle venk. s cylindr. otvorem	Kč €	1020,- 43,-	064322	1460,- 61,-	064360	1460,- 61,-	142846



Příbuzný sortiment

Madla a koule na skleněné a dřevěné dveře



Bezpečnostní rozety



Okenní kliky 3 a 4 polohové



Bezpečnostní madla Entero



Madla dlouhá



## Kování pro hliníkové a ocelové dveře, kování na branky

Kování M&T pro hliníkové a ocelové dveře splňuje ty nejnáročnější požadavky na konstrukci a funkčnost na namáhaných dveřích tohoto typu. Nová konstrukce vnitřních rozet se systémem tlačných pružin s nerezovým jádrem perfektně fixuje funkční čtyřhran mezi zámkem a kovááním a tím nedochází k hýbání a svěšování klik. Rozety jsou navíc opatřeny dvojicí zajišťovacích červíků, které pevně fixují celé kování k vnitřní konstrukci. Tento konstrukční systém je zároveň vhodný pro branky a všechny vstupní prostory, kde je požadavek na montáž do uzších profilů bez možnosti prošroubování skrze dveřní zámek. Samozřejmostí je montáž také na dřevěné dveře. Zde doporučujeme povrch NRz, TiN-C a TiN-K.

Materiál: masivní mosaz

Povrchy: SNI, SNI – broušeno, Cr, TiN-C, TiN-K, TiN-B, Ms, Ms-L, Cr-K, zakázkově TiN-A  
více info na [www.kliky-mt.cz/manufaktura/barvy-povrchy](http://www.kliky-mt.cz/manufaktura/barvy-povrchy)

Materiál: nerezová ocel

Povrchy: NRz, TiN-K, K-industrial

### MINIMAL Cr lesklý chrom



### ENTERO NRz nerez -broušeno



#### konstrukční varianty, materiálové provedení

- dokonalá montáž pro všechny typy Al a ocelových dveří
- rozety s minimálním rozměrem 33x47 mm, tl. 12 mm
- doporučený výstup cylindrické vložky ze dveří 12 mm
- varianta rozety i s ochrannou překrytkou
- u varianty s ochrannou překrytkou max. výstup 8 mm
- konstrukční systém 4 tlačných pružin u kliky
- nerezové jádro vnitřní konstrukce
- montáž pomocí až 12-ti samořezných vrtů
- další fixace rozety pomocí červíků M4
- rukojeti a rozety vyrobeny z masivní mosazi
- zajišťovací gel proti uvolnění šroubů
- vrtání PROFI šablonou M&T
- montáž pro tloušťky dveří 38 – 126 mm
- záruka 3 roky, titany 15 let

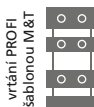

roky **3 garance** let **15 garance**

Ochranné známky – registrované značky



MINIMAL®  
ENTERO®

Chráněné průmyslové vzory klik



ENTERO  
MINIMAL  
MIMOLIMIT  
ENTRY  
TERRY  
TRINITY  
MY  
TORO  
TUKAN  
MAYA

Patent

patent

konstrukce oviadani kliky se systémem tlačných pružin, s velmi tichým chodem a trojitou stabilizací kliky

- dokonalá montáž pro všechny typy Al a ocelových dveří
- rozety s minimálním rozměrem 33x49 mm, tl. 12 mm
- doporučený výstup cylindrické vložky ze dveří 12 mm
- varianta rozety i s ochrannou překrytkou
- u varianty s ochrannou překrytkou max. výstup 8 mm
- konstrukční systém 4 tlačných pružin u kliky
- nerezové jádro vnitřní konstrukce
- montáž pomocí až 12-ti samořezných vrtů
- další fixace rozety pomocí červíků M4
- rukojeti a rozety vyrobeny z nerez oceli
- u protipožární varianty spojovací prvky a čtyřhran z nerez oceli
- zajišťovací gel proti uvolnění šroubů
- vrtání PROFI šablonou M&T
- montáž pro tloušťky dveří 38 – 126 mm
- záruka 5 let, titany 15 let

let **5 garance** let **15 garance**

Zatřídění kování podle normy EN 1906:2012, ČSN EN 1906 16 5776  
Prohlášení o shodě na [www.kliky-mt.cz/certifikaty](http://www.kliky-mt.cz/certifikaty)

Objekt **36-0031B**

Projekt tř. 4 **47-D1141B**

popisy číselného značení na str. 31 Dveřní kliky NEREZ



SNi matný nikl



TiN-K titan černý mat



Cr lesklý chrom

**Trinity**

3490,- Kč  
146,- EUR

**Entry**

3950,- Kč  
165,- EUR

**Entero**

3950,- Kč  
165,- EUR

**Terry**

3640,- Kč  
152,- EUR

**My**

3640,- Kč  
152,- EUR

**Minimal**

4590,- Kč  
192,- EUR

**KČ** materiál: masivní mosaz povrch: SNi matný nikl **EUR**

3490,-  146,-

4570,-   191,-

4570,-   191,-

3950,-  165,-

5040,-   210,-

5040,-   210,-

3950,-  165,-

5040,-   210,-

5040,-   210,-

3640,-  152,-

4740,-   198,-

4740,-   198,-

3640,-  152,-

4740,-   198,-

4740,-   198,-

**KČ** materiál: masivní mosaz povrch: SNi matný nikl **EUR**

4590,-  192,-

5210,-   218,-

5210,-   218,-



		SNI		SNI - broušeno		Cr		Ms		TiN-C		TiN-K	
		cena / pár	EAN	cena / pár	EAN	cena / pár	EAN	cena / pár	EAN	cena / pár	EAN	cena / pár	EAN
klika / klika	Kč €	3490,- 146,-	037401	3590,- 150,-	35263	3720,- 155,-	35294	3720,- 155,-	059953	4810,- 201,-	35355	4810,- 201,-	35386
madlo / klika R	Kč €	4570,- 191,-	037418	4650,- 194,-	35270	4810,- 201,-	35300	4810,- 201,-	059960	5910,- 247,-	35362	5910,- 247,-	35393
madlo / klika L	Kč €	4570,- 191,-	037425	4650,- 194,-	35287	4810,- 201,-	35317	4810,- 201,-	059977	5910,- 247,-	35379	5910,- 247,-	35409
klika / klika	Kč €	3950,- 165,-	037432	4050,- 169,-	35416	4180,- 175,-	35447	4180,- 175,-	060010	5280,- 220,-	35508	5280,- 220,-	35539
madlo / klika R	Kč €	5040,- 210,-	037449	5120,- 214,-	35423	5280,- 220,-	35454	5280,- 220,-	060027	6520,- 272,-	35515	6520,- 272,-	35546
madlo / klika L	Kč €	5040,- 210,-	037456	5120,- 214,-	35430	5280,- 220,-	35461	5280,- 220,-	060034	6520,- 272,-	35522	6520,- 272,-	35553
klika / klika	Kč €	3950,- 165,-	037463	4050,- 169,-	42957	4180,- 175,-	42988	4180,- 175,-	060072	5280,- 220,-	43169	5280,- 220,-	43190
madlo / klika R	Kč €	5040,- 210,-	037470	5120,- 214,-	42964	5280,- 220,-	42995	5280,- 220,-	060089	6520,- 272,-	43176	6520,- 272,-	43206
madlo / klika L	Kč €	5040,- 210,-	037487	5120,- 214,-	42971	5280,- 220,-	43121	5280,- 220,-	060096	6520,- 272,-	43183	6520,- 272,-	43213
klika / klika	Kč €	3640,- 152,-	037494	3720,- 155,-	35560	3890,- 163,-	35591	3890,- 163,-	060133	4980,- 208,-	42872	4980,- 208,-	42926
madlo / klika R	Kč €	4740,- 198,-	037500	4810,- 201,-	35577	4980,- 208,-	35607	4980,- 208,-	060140	6050,- 253,-	42902	6050,- 253,-	42933
madlo / klika L	Kč €	4740,- 198,-	037517	4810,- 201,-	35584	4980,- 208,-	42834	4980,- 208,-	060157	6050,- 253,-	42919	6050,- 253,-	42940
klika / klika	Kč €	3640,- 152,-	037524	3720,- 155,-	43220	3890,- 163,-	64911	3890,- 163,-	060195	4980,- 208,-	64973	4980,- 208,-	65000
madlo / klika R	Kč €	4740,- 198,-	037531	4810,- 201,-	43237	4980,- 208,-	64928	4980,- 208,-	060201	6050,- 253,-	64980	6050,- 253,-	65017
madlo / klika L	Kč €	4740,- 198,-	037548	4810,- 201,-	64904	4980,- 208,-	64935	4980,- 208,-	060218	6050,- 253,-	64997	6050,- 253,-	65024



		SNI		SNI - broušeno		Cr		Ms		TiN-C		TiN-B		TiN-K	
		cena	EAN	cena	EAN	cena	EAN	cena	EAN	cena	EAN	cena	EAN	cena	EAN
klika / klika	Kč €	4590,- 192,-	003062	4660,- 195,-	003079	4870,- 203,-	003086	4870,- 203,-	060256	5990,- 250,-	003093	5990,- 250,-	003109	5990,- 250,-	003116
madlo / klika R	Kč €	5210,- 218,-	003130	5290,- 221,-	003147	5490,- 229,-	003154	5490,- 229,-	060263	6610,- 276,-	003161	6610,- 276,-	003178	6610,- 276,-	003185
madlo / klika L	Kč €	5210,- 218,-	003208	5290,- 221,-	003215	5490,- 229,-	003222	5490,- 229,-	060270	6610,- 276,-	003239	6610,- 276,-	003246	6610,- 276,-	003253

U kombinace madlo / klika dodáváme standardně madlo Minimal pevné - neotočné. Na základě požadavku madlo Entero pevné - neotočné. Lze dodat madlo Entero otočné s funkcí kličky. V balení je standardně montážní materiál pro tl. dveří 38 - 45 mm. Nad 45 mm je třeba uvádět přesnou tl. dveří. Cena montážního materiálu pro jiné tl. dveří je zahrnuta v ceně kování.

Vhodnost jednotlivých designů - tvarů klik pro konkrétní zakázku musí ověřit výrobce dveří podle rozměru Dornmas zvoleného zámku. Pro zámek s rozměrem Dornmas 40 mm a vyšším lze použít všechny kličky z nabídky M&T pro hliníkové a ocelové dveře.



SNi matný nikl

**Lusy**

2450,- Kč  
 103,- EUR

**Kč**      materiál: masivní mosaz  
 povrch: SNi matný nikl      **EUR**

2450,-            103,-

3260,-            136,-

3260,-            136,-

**Garanti**

2390,- Kč  
 100,- EUR

2390,-            100,-

3200,-            134,-

3200,-            134,-

**Sogut**

2720,- Kč  
 114,- EUR

2720,-            114,-

3530,-            148,-

3530,-            148,-

**Cesan**

2330,- Kč  
 98,- EUR

2330,-            98,-

3160,-            132,-

3160,-            132,-

**Cherez**

3190,- Kč  
 133,- EUR

3190,-            133,-

4280,-            179,-

4280,-            179,-



		Sni		Cr		Ms		Cr-K		TiN-C		TiN-K	
		cena pár	EAN	cena pár	EAN	cena pár	EAN	cena pár	EAN	cena pár	EAN	cena pár	EAN
klika / klika	Kč €	2450,- 103,-	024173	2760,- 115,-	024203	2760,- 115,-	060317	3410,- 143,-	066531	3690,- 154,-	024234	3690,- 154,-	024265
madlo / klika R	Kč €	3260,- 136,-	024180	3590,- 150,-	024210	3590,- 150,-	060324	4570,- 191,-	066548	4650,- 194,-	024241	4650,- 194,-	024272
madlo / klika L	Kč €	3260,- 136,-	024197	3590,- 150,-	024227	3590,- 150,-	060331	4570,- 191,-	066555	4650,- 194,-	024258	4650,- 194,-	024289
klika / klika	Kč €	2390,- 100,-	024326	2700,- 113,-	024357	2700,- 113,-	060379	3330,- 139,-	066562	3630,- 152,-	024388	3630,- 152,-	024418
madlo / klika R	Kč €	3200,- 134,-	024333	3500,- 146,-	024364	3500,- 146,-	060386	4900,- 205,-	066579	4590,- 192,-	024395	4590,- 192,-	024425
madlo / klika L	Kč €	3200,- 134,-	024340	3500,- 146,-	024371	3500,- 146,-	060393	4900,- 205,-	066586	4590,- 192,-	024401	4590,- 192,-	024432
klika / klika	Kč €	2720,- 114,-	024470	3020,- 126,-	024500	3020,- 126,-	060430	3800,- 159,-	066593	3950,- 165,-	024531	3950,- 165,-	024562
madlo / klika R	Kč €	3530,- 148,-	024487	3860,- 161,-	024517	3860,- 161,-	060447	4960,- 207,-	066609	4940,- 206,-	024548	4940,- 206,-	024579
madlo / klika L	Kč €	3530,- 148,-	024494	3860,- 161,-	024524	3860,- 161,-	060454	4960,- 207,-	066616	4940,- 206,-	024555	4940,- 206,-	024586
klika / klika	Kč €	2330,- 98,-	027181	2650,- 111,-	027211	2650,- 111,-	060492	3260,- 136,-	066623	3590,- 150,-	027242	3590,- 150,-	027273
madlo / klika R	Kč €	3160,- 132,-	027198	3450,- 144,-	027228	3450,- 144,-	060508	4380,- 183,-	066630	4550,- 190,-	027259	4550,- 190,-	027280
madlo / klika L	Kč €	3160,- 132,-	027204	3450,- 144,-	027235	3450,- 144,-	060515	4380,- 183,-	066647	4550,- 190,-	027266	4550,- 190,-	027297
klika / klika	Kč €	3190,- 133,-	027334	3490,- 146,-	027365	3490,- 146,-	060553	4430,- 185,-	066654	4420,- 185,-	027396	4420,- 185,-	027426
madlo / klika R	Kč €	4280,- 179,-	027341	4590,- 192,-	027372	4590,- 192,-	060560	5990,- 250,-	066661	5680,- 237,-	027402	5680,- 237,-	027433
madlo / klika L	Kč €	4280,- 179,-	027358	4590,- 192,-	027389	4590,- 192,-	060577	5990,- 250,-	066678	5680,- 237,-	027419	5680,- 237,-	027440

U kombinace madlo / klika dodáváme standardně madlo Entero pevné - neotočné. Na základě požadavku madlo Minimal pevné - neotočné. Lze dodat madlo Entero otočné s funkcí kliky. V balení je standardně montážní materiál pro tl. dveří 38 - 45 mm. Nad 45 mm je třeba uvádět přesnou tl. dveří. Cena montážního materiálu pro jiné tl. dveří je zahrnuta v ceně kování.

## Kování Mini pro hliníkové a ocelové dveře



Ms mosaz natural



TiN-K titan černá mat



Cr lesklý chrom

### Mini-V

2650,- Kč  
111,- EUR

KČ materiál: masivní mosaz  
povrch: SNI matný nikel EUR

2650,-  111,-

3590,-   150,-

3590,-   150,-

### Mini-C

2490,- Kč  
104,- EUR

2490,-  104,-

3420,-   143,-

3420,-   143,-

### Mini-S

2490,- Kč  
104,- EUR

2490,-  104,-

3420,-   143,-

3420,-   143,-

### Mini-T

2490,- Kč  
104,- EUR

2490,-  104,-

3420,-   143,-

3420,-   143,-





		Sni		Cr		Ms		Ms-L		TiN-K	
		cena pár	EAN	cena pár	EAN	cena pár	EAN	cena pár	EAN	cena pár	EAN
klika / klika	Kč €	2650,- 111,-	064988	2960,- 124,-	065015	2960,- 124,-	065077	2960,- 124,-	065107	3890,- 163,-	065046
madlo / klika R	Kč €	3590,- 150,-	064995	3890,- 163,-	065022	3890,- 163,-	065084	3890,- 163,-	065114	4810,- 201,-	065053
madlo / klika L	Kč €	3590,- 150,-	065008	3890,- 163,-	065039	3890,- 163,-	065091	3890,- 163,-	065121	4810,- 201,-	065060
klika / klika	Kč €	2490,- 104,-	065954	2790,- 117,-	065985	2790,- 117,-	066043	2790,- 117,-	066074	3720,- 155,-	066012
madlo / klika R	Kč €	3420,- 143,-	065961	3720,- 155,-	065992	3720,- 155,-	066050	3720,- 155,-	066081	4650,- 194,-	066029
madlo / klika L	Kč €	3420,- 143,-	065978	3720,- 155,-	066005	3720,- 155,-	066067	3720,- 155,-	066098	4650,- 194,-	066036
klika / klika	Kč €	2490,- 104,-	066104	2790,- 117,-	066135	2790,- 117,-	066197	2790,- 117,-	066227	3720,- 155,-	066166
madlo / klika R	Kč €	3420,- 143,-	066111	3720,- 155,-	066142	3720,- 155,-	066203	3720,- 155,-	066234	4650,- 194,-	066173
madlo / klika L	Kč €	3420,- 143,-	066128	3720,- 155,-	066159	3720,- 155,-	066210	3720,- 155,-	066241	4650,- 194,-	066180
klika / klika	Kč €	2490,- 104,-	066258	2790,- 117,-	066289	2790,- 117,-	066340	2790,- 117,-	066371	3720,- 155,-	066319
madlo / klika R	Kč €	3420,- 143,-	066265	3720,- 155,-	066296	3720,- 155,-	066357	3720,- 155,-	066388	4650,- 194,-	066326
madlo / klika L	Kč €	3420,- 143,-	066272	3720,- 155,-	066302	3720,- 155,-	066364	3720,- 155,-	066395	4650,- 194,-	066333



SNi matný nikel + teak

**Mimolimit**

4350,- Kč  
182,- EUR



**Toro**

4350,- Kč  
182,- EUR

materiál: masivní mosaz  
Kč povrch: SNi matný nikel broušeno EUR

4350,- 182,-

5590,- 233,-

5590,- 233,-

4350,- 182,-

5590,- 233,-

5590,- 233,-

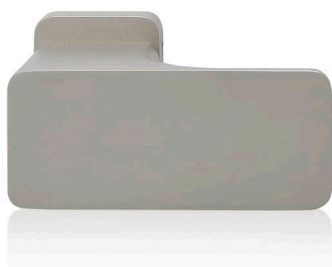

**Minimal  
madlo / madlo**  
pevné - neotočné

Kč materiál: masivní mosaz  
povrch: SNi matný nikel EUR

5150,- 215,-

**Entero  
madlo / madlo**  
pevné - neotočné

4830,- 202,-

SNi matný nikel



**Rozeta 33x47 mm**

790,- Kč  
33,- EUR

Kč materiál: masivní mosaz  
povrch: SNi matný nikel EUR

790,- 33,-

1250,- 53,-

930,- 39,-



**Entero  
madlo / madlo**  
pevné - neotočné

Kč materiál: nerezová ocel  
povrch: NRz nerez - broušeno EUR

4550,- 190,-

Kč materiál: nerezová ocel  
povrch: NRz nerez - broušeno EUR

**Rozety 33x49 mm**

880,- Kč  
37,- EUR

880,- 37,-

1320,- 55,-

1020,- 43,-



NRz nerez - broušeno



		Sni - broušeno		Cr		Ms		TiN-C		TiN-K		TiN-B	
		cena / pár	EAN	cena / pár	EAN	cena / pár	EAN	cena / pár	EAN	cena / pár	EAN	cena / pár	EAN
klika / klika	Kč €	4350,- 182,-	65031	4520,- 189,-	65062	4520,- 189,-	060614	5590,- 233,-	055399	5590,- 233,-	65093	5590,- 233,-	84339
madlo / klika R	Kč €	5590,- 233,-	65048	5740,- 240,-	65079	5740,- 240,-	060621	6980,- 291,-	055405	6980,- 291,-	65109	6980,- 291,-	84346
madlo / klika L	Kč €	5590,- 233,-	65055	5740,- 240,-	65086	5740,- 240,-	060638	6980,- 291,-	055412	6980,- 291,-	65116	6980,- 291,-	84353
klika / klika	Kč €	4350,- 182,-	65567	4520,- 189,-	65598	4520,- 189,-	060676	5590,- 233,-	055429			5590,- 233,-	65628
madlo / klika R	Kč €	5590,- 233,-	65574	5740,- 240,-	65604	5740,- 240,-	060683	6980,- 291,-	055436			6980,- 291,-	65635
madlo / klika L	Kč €	5590,- 233,-	65581	5740,- 240,-	65611	5740,- 240,-	060690	6980,- 291,-	055443			6980,- 291,-	65642

U kombinace madlo / klika dodáváme standardně madlo Minimal pevné - neočtné. Na základě požadavku madlo Entero pevné - neočtné. Lze dodat madlo Entero otočné s funkcí kliky. V balení je standardně montážní materiál pro tl. dveří 38 - 45 mm. Nad 45 mm je třeba uvádět přesnou tl. dveří. Cena montážního materiálu pro jiné tl. dveří je zahrnuta v ceně kování.



		Sni		Sni - broušeno		Cr		Ms		TiN-C		TiN-B		TiN-K	
		cena / pár	EAN	cena / pár	EAN	cena / pár	EAN	cena / pár	EAN	cena / pár	EAN	cena / pár	EAN	cena / pár	EAN
Minimal madlo/madlo	Kč €	5150,- 215,-	026931	5220,- 218,-	026962	5290,- 221,-	026993	5290,- 221,-	060737	6380,- 266,-	027020	6380,- 266,-	027051	6380,- 266,-	027082
Entero madlo/madlo	Kč €	4830,- 202,-	026948	4910,- 205,-	026979	4990,- 208,-	027006	4990,- 208,-	060744	6060,- 253,-	027037	6060,- 253,-	027068	6060,- 253,-	027099
rozeta cylindrická	Kč €	790,- 33,-	001952	830,- 35,-	001969	870,- 37,-	001976	870,- 37,-	060775	1250,- 53,-	001983	1250,- 53,-	002669	1250,- 53,-	002676
rozeta *) cylindrická s překrytkou	Kč €	1250,- 53,-	030884	1300,- 55,-	030891	1330,- 56,-	030907	1330,- 56,-	060782	1720,- 72,-	030914	1720,- 72,-	030921	1720,- 72,-	030938
rozeta zaslepovací	Kč €	930,- 39,-	022353	1000,- 42,-	022360	1090,- 46,-	022377	1090,- 46,-	060799	1250,- 53,-	022384	1250,- 53,-	022391	1250,- 53,-	022407

		Objekt nerez NRz		Objekt titan TiN-K		Objekt K-industrial		Projekt tř. 4, (i protipožární) NRz		Projekt tř. 4, (i protipožární) TiN-K	
		cena / pár	EAN	cena / pár	EAN	cena / pár	EAN	cena / pár	EAN	cena / pár	EAN
Entero madlo/madlo	Kč €	4550,- 190,-	027143	5720,- 239,-	027150	5720,- 239,-	034042	4840,- 202,-	027167	6020,- 251,-	027174

		NRz		TiN-K		K-industrial	
		cena / pár	EAN	cena / pár	EAN	cena / pár	EAN
rozeta cylindrická	Kč €	880,- 37,-	024098	1180,- 50,-	024111	1180,- 50,-	034059
rozeta cylindrická s překrytkou *)	Kč €	1320,- 55,-	030952	1620,- 68,-	030969	1620,- 68,-	034066
rozety zaslepovací	Kč €	1020,- 43,-	024104	1320,- 55,-	024128	1320,- 55,-	034073

\*) Při objednání rozety s překrytkou je třeba uvádět orientaci dveří (levé / pravé) a směr otevírání (ven / dovnitř).



NRz nerez - broušeno

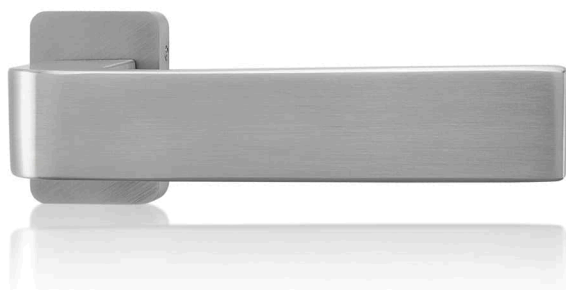
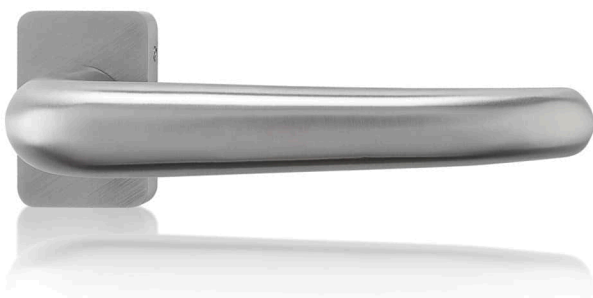
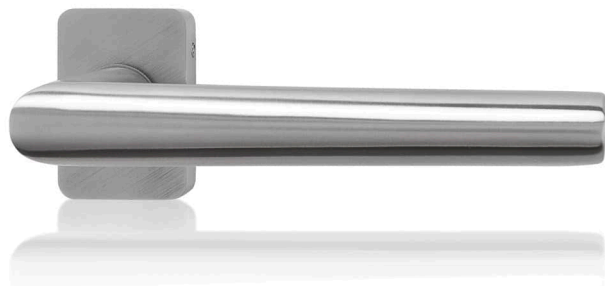
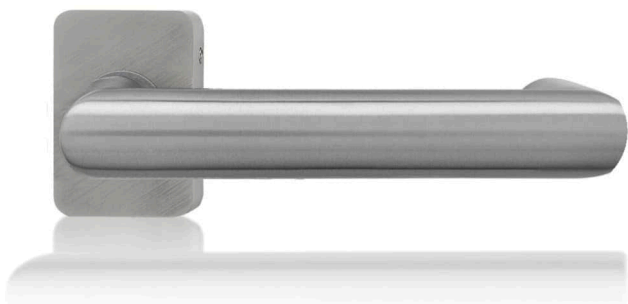

materiál: nerezová ocel  
 povrch: NRz nerez - broušeno

**KČ** **EUR**

**Lusy**

1910,- 80,-



1910,- KČ  
 80,- EUR

2640,- 110,-



2640,- 110,-



**Hanna**

2190,- 92,-



2190,- KČ  
 92,- EUR

2930,- 123,-



2930,- 123,-



**Morgan**

2050,- 86,-



2050,- KČ  
 86,- EUR

2780,- 116,-



2780,- 116,-



**Entero**

2640,- 110,-



2640,- KČ  
 110,- EUR

3380,- 141,-



3380,- 141,-



**Cesan**

2350,- 98,-



2350,- KČ  
 98,- EUR

3070,- 128,-



3070,- 128,-



**Promo**

2640,- 110,-



2640,- KČ  
 110,- EUR

3380,- 141,-



3380,- 141,-



		Objekt nerez		Objekt titan		Objekt		Projekt tř. 4, (i protipožární)		Projekt tř. 4, (i protipožární)	
		NRz		TiN-K		K-industrial		NRz		TiN-K	
		cena / pár	EAN	cena / pár	EAN	cena / pár	EAN	cena / pár	EAN	cena / pár	EAN
klika / klika	Kč €	1910,- 80,-	024623	3070,- 128,-	024654	3070,- 128,-	034080	2190,- 92,-	024685	3380,- 141,-	024715
madlo / klika R	Kč €	2640,- 110,-	024630	3810,- 159,-	024661	3810,- 159,-	034097	2930,- 123,-	024692	4100,- 171,-	024722
madlo / klika L	Kč €	2640,- 110,-	024647	3810,- 159,-	024678	3810,- 159,-	034103	2930,- 123,-	024708	4100,- 171,-	024739
klika / klika	Kč €	2190,- 92,-	046861	3380,- 141,-	102048	3380,- 141,-	144307	2490,- 104,-	102079	3660,- 153,-	102109
madlo / klika R	Kč €	2930,- 123,-	046878	4100,- 171,-	102055	4100,- 171,-	144314	3220,- 135,-	102086	4380,- 183,-	102116
madlo / klika L	Kč €	2930,- 123,-	046885	4100,- 171,-	102062	4100,- 171,-	144321	3220,- 135,-	102093	4380,- 183,-	102123
klika / klika	Kč €	2050,- 86,-	024869	3220,- 135,-	024890	3220,- 135,-	034172	2350,- 98,-	024920	3510,- 147,-	024951
madlo / klika R	Kč €	2780,- 116,-	024876	3950,- 165,-	024906	3950,- 165,-	034189	3070,- 128,-	024937	4250,- 178,-	024968
madlo / klika L	Kč €	2780,- 116,-	024883	3950,- 165,-	024913	3950,- 165,-	034196	3070,- 128,-	024944	4250,- 178,-	024975
klika / klika	Kč €	2640,- 110,-	024746	3810,- 159,-	024777	3810,- 159,-	034325	2930,- 123,-	024807	4100,- 171,-	024838
madlo / klika R	Kč €	3380,- 141,-	024753	4540,- 190,-	024784	4540,- 190,-	034332	3660,- 153,-	024814	4830,- 202,-	024845
madlo / klika L	Kč €	3380,- 141,-	024760	4540,- 190,-	024791	4540,- 190,-	034349	3660,- 153,-	024821	4830,- 202,-	024852
klika / klika	Kč €	2350,- 98,-	026818	3510,- 147,-	026849	3510,- 147,-	034417	2640,- 110,-	026870	3810,- 159,-	026900
madlo / klika R	Kč €	3070,- 128,-	026825	4250,- 178,-	026856	4250,- 178,-	034424	3380,- 141,-	026887	4540,- 190,-	026917
madlo / klika L	Kč €	3070,- 128,-	026832	4250,- 178,-	026863	4250,- 178,-	034431	3380,- 141,-	026894	4540,- 190,-	026924
klika / klika	Kč €	2640,- 110,-	025743			3810,- 159,-	034295	2930,- 123,-	025804		
madlo / klika R	Kč €	3380,- 141,-	025750			4540,- 190,-	034301	3660,- 153,-	025811		
madlo / klika L	Kč €	3380,- 141,-	025767			4540,- 190,-	034318	3660,- 153,-	025828		

U kombinace madlo / klika dodáváme standardně madlo Entero pevné - neotočné.  
Cena montážního materiálu pro jiné tloušťky dveří je zahrnuta v ceně kování.



Příbuzný sortiment

Madla a koule na skleněné  
a dřevěné dveře



Mušle Minimal / Maximal  
na skleněné posuvné dveře



Madla dlouhá

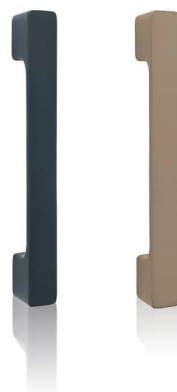

Posuvný systém MINIMA pro dřevěné  
a skleněné dveře



## Mušle na posuvné dveře

Mušle na posuvné dveře M&T jsou připraveny v 7-mi designových řadách, kdy každá řada má svoji charakteristiku použití. Mušle Entero a Entry jsou také ve variantě s WC ohebným mechanismem, kdy se posuvné dveře můžou celé bez omezení zasunout do stavebního pouzdra, stejně tak mušle Minimal II / Maximal II, které jsou navíc ve variantách se všemi typy zámků, s různými možnostmi zamykání, s velmi rychlou a přesnou montáží a to z nich činí naprostou jedničku nejen v nabídce M&T ...

Materiál: **masivní mosaz**

Povrchy: **SNi, Cr, SNi-broušeno, TiN-C, TiN-B, TiN-K, Ms, Ms-L, zakázkově TiN-A**  
více info na [www.kliky-mt.cz/manufaktura/barvy-povrchy](http://www.kliky-mt.cz/manufaktura/barvy-povrchy)

Materiál: **nerezová ocel**

Povrchy: **NRz, K-industrial**

**ENTERO SNi**  
matný nikl

**MAYA SNi**  
matný nikl

**MINIMAL Cr**  
lesklý chrom

**MINIMAL II SNi**  
matný nikl

**ENTRY TiN-K**  
titan čený mat

**ENTERO II NRz**  
nerez broušeno

**NOVA NRz**  
nerez broušeno



1. v naší nabídce

### Variety provedení

Standard  
Standard s pouzdry  
WC  
WC s pouzdry  
Ohebné WC  
Ohebné WC s pouzdry

Standard  
Dozické  
Cylindrické  
WC  
Sklo

Standard  
Dozické  
Cylindrické  
Ohebné WC

Standard  
Dozické  
Cylindrické  
Ohebné WC

Standard  
Dozické  
Cylindrické  
Ohebné WC

Standard  
WC s rozetou

Standard  
WC s rozetou

### Variety povrchových úprav

SNi, SNi-broušeno

SNi

SNi, Cr, SNi-broušeno,  
TiN-C, TiN-B,  
TiN-K, TiN-A, Ms

SNi, Cr, TiN-K

SNi, TiN-K

NRz

NRz

### konstrukční varianty

- sady muší se zamykáním jsou dodávány vždy v ceně se zadlabacím zámkem
- mušle bez zamykání jsou montážně připraveny pro dveře od minimální tloušťky 37 mm
- mušle se zamykáním jsou montážně připraveny pro dveře od minimální tloušťky 39 mm
- mušle s ohebným WC lze celé bez omezení zasunout do stavebního pouzdra
- k mušlím je připraven boční úchyt Entero pro snadné vysouvání dveří ze stavebního pouzdra
- výkresy frézování, animace montáže na [www.kliky-mt.cz/montaze-kovani](http://www.kliky-mt.cz/montaze-kovani)
- mušle Entero s pouzdry se montují pomocí šroubků proti sobě
- mušle Maya se montují pomocí šroubků proti sobě
- mušle Minimal a Minimal II se montují pomocí šroubků proti sobě
- mušle Entry se montují pomocí šroubků proti sobě
- mušle Entero NRz a Nova NRz se fixují skrytými vruty do stěny dveří
- záruka 3 roky, NRz 5 let, titány 15 let

roky **3 garance** let **5 garance** let **15 garance**

### Ochranné známky – registrované značky



**ENTERO®**  
**MINIMAL®**  
**MAXIMAL®**

### Chráněné průmyslové vzory muší



**MINIMAL**  
**MAXIMAL**  
**MINIMAL II**  
**MAXIMAL II**  
**ENTRY**

### Patent



Konstrukce a systém tlačných pružin u muší Minimal, Maximal  
Konstrukce a systém montáže muší Minimal II / Maximal II, Entry

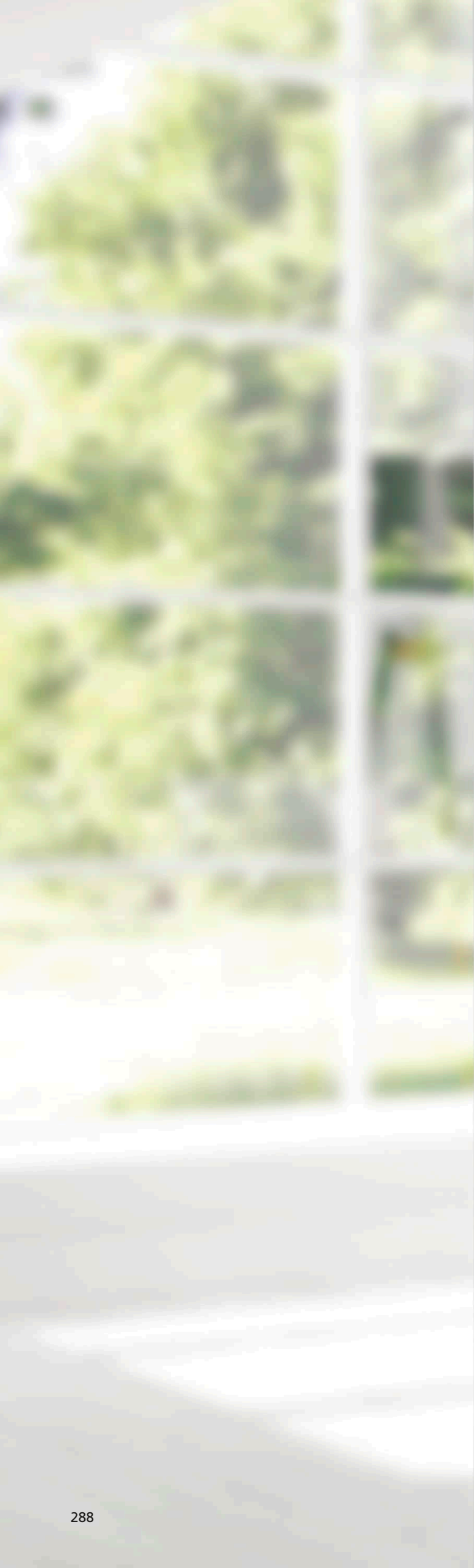



## Minimal II / Maximal II

### nejlepší mušle v naší nabídce

- nejdokonalejší montáž
- nejrychlejší montáž
- nejsnadnější montáž
- všechny varianty zamykání
- v setu se zámkem a protiplechem
- s magnetickou deskou / výplní pro dokonalý design
- ohebné WC, které nepřesahuje okraj mušle
- univerzální otvor frézování do dveří pro všechny varianty muší

Na magnetickou desku uvnitř mušle se vkládá výplň totožná s povrchem křídla dveří pro neviditelný efekt mušle Maximal.



**MINIMAL II SNI**  
 matný nikel



**Cr** lesklý chrom



**TiN-K** titan černý mat



**MAXIMAL II SNI** matný nikel  
 výplň dřevo - dýha teak



**TiN-K** titan černý mat  
 výplň dřevo - dýha teak



SNi matný nikel

**Mušle Minimal II**

930,- Kč  
39,- EUR



TiN-K titan černý mat



Maximal Cr lesklý chrom + výplň efekt „sklo“ - bílá glanz

**Výplň mušle  
Maximal II**

300,- Kč  
13,- EUR

materiál: kovové tělo + magnetická výplň  
Kč povrch: SNi matný nikel EUR

Kč	EUR
930,-	39,-
2600,-	109,-
2600,-	109,-
3710,-	155,-



**Mušle Maximal II**

930,- Kč  
39,- EUR

Kč	EUR
930,-	39,-
2600,-	109,-
2600,-	109,-
3710,-	155,-



		Sni		Cr		TiN-K	
		cena	EAN	cena	EAN	cena	EAN
standard	Kč €	ks 930,- 39,-	101751	ks 1200,- 50,-	101768	ks 1610,- 68,-	101775
dozická	Kč €	pár 2600,- 109,-	101782	pár 3010,- 126,-	101799	pár 3940,- 165,-	101805
cylindrická	Kč €	pár 2600,- 109,-	101812	pár 3010,- 126,-	101829	pár 3940,- 165,-	101836
WC / koupelna	Kč €	pár 3710,- 155,-	101843	pár 3990,- 167,-	101850	pár 5190,- 217,-	101867

Sada se zadlabacím zámkem, protiplechem a krycí vaničkou.

		Sni		Cr		TiN-K	
		cena	EAN	cena	EAN	cena	EAN
standard	Kč €	ks 930,- 39,-	101874	ks 1200,- 50,-	101881	ks 1610,- 68,-	101898
dozická	Kč €	pár 2600,- 109,-	101904	pár 3010,- 126,-	101911	pár 3940,- 165,-	101928
cylindrická	Kč €	pár 2600,- 109,-	101935	pár 3010,- 126,-	101942	pár 3940,- 165,-	101959
WC / koupelna	Kč €	pár 3710,- 155,-	101966	pár 3990,- 167,-	101973	pár 5190,- 217,-	101980

Sada se zadlabacím zámkem, protiplechem a krycí vaničkou.

		cena	EAN
		pár	
dřevo	Kč €	300,- 13,-	001778
kov	Kč €	300,- 13,-	001785
kůže	Kč €	400,- 17,-	001792
efekt „sklo“	Kč €	400,- 17,-	001808
RAL barvy	Kč €	440,- 19,-	022506

více informací na str. 286 - 287 Mušle na posuvné dveře  
Výplně k mušlím Maximal i Maximal II se objednávají pod stejným EAN.





Možnost vložení / instalace různých povrchů a materiálů do mušle pomocí magnetické desky.



**Mušle Entry**

870,- Kč  
 37,- EUR

Kč	materiál: povrch: SNi matný nikel	EUR
870,-		37,-
2320,-		97,-
2320,-		97,-
2890,-		121,-



TiN-K titan černý mat

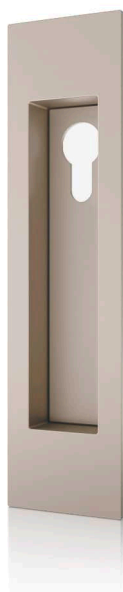

SNi matný nikel



	SNI		TiN-K		
	cena	EAN	cena	EAN	
standard	Kč €	ks 870,- 37,-	155693	ks 1470,- 62,-	155730
dozická	Kč €	pár 2320,- 97,-	155709	pár 3520,- 147,-	155747
cylindrická	Kč €	pár 2320,- 97,-	155716	pár 3520,- 147,-	155754
WC / koupelna	Kč €	pár 2890,- 121,-	155723	pár 4570,- 191,-	155761

Sada se zadlabacím zámkem, protiplechem a vaničkou.





SNi matný nikel



TiN-K titan černý mat  
WC

**Mušle Entero**

1020,- Kč  
43,- EUR

Kč	EUR
1020,-	43,-
1020,-	43,-
2930,-	123,-
2930,-	123,-
3220,-	135,-
3220,-	135,-



WC s pouzdry



ohébné WC



ohébné WC s pouzdry



SNi matný nikel



**Mušle Maya**

2490,- Kč  
104,- EUR

Kč	EUR
2490,-	104,-
2930,-	123,-
2930,-	123,-
3660,-	153,-
2780,-	116,-



		SNI		SNI - broušeno		TiN-K*	
		cena	EAN	cena	EAN	cena	EAN
standard	Kč €	ks 1020,- 43,-	74095	ks 1090,- 46,-	74118	ks 1910,- 80,-	066456
standard s pouzdry	Kč €	ks 1020,- 43,-	74361	ks 1090,- 46,-	74385	ks 1910,- 80,-	066463
WC	Kč €	pár 2930,- 123,-	17863	pár 3070,- 128,-	17856	pár 4830,- 202,-	066470
WC s pouzdry	Kč €	pár 2930,- 123,-	17917	pár 3070,- 128,-	17931	pár 4830,- 202,-	066487
s ohebným WC	Kč €	pár 3220,- 135,-	89389	pár 3380,- 141,-	89402	pár 5120,- 214,-	066494
s ohebným WC s pouzdry	Kč €	pár 3220,- 135,-	89396	pár 3380,- 141,-	89419	pár 5120,- 214,-	066500

Sada se zadlabacím zámkem, protiplechem a krycí vaničkou.

\* Upozorňujeme na možnost hrubšího povrchu uvnitř mušle. Hrubší povrch nemá omezení týkající se manipulace s mušlí a pohledově nenarušuje celkový vzhled mušle.

		SNI	
		cena / pár	EAN
standard	Kč €	2490,- 104,-	61842
dozická	Kč €	2930,- 123,-	61859
cyklindrická	Kč €	2930,- 123,-	61866
WC	Kč €	3660,- 153,-	61873
na sklo	Kč €	2780,- 116,-	61880

Sada se zadlabacím zámkem, protiplechem a krycí vaničkou.



MINIMAL SNI  
matný nikl



**Mušle Minimal**

5760,- Kč  
240,- EUR

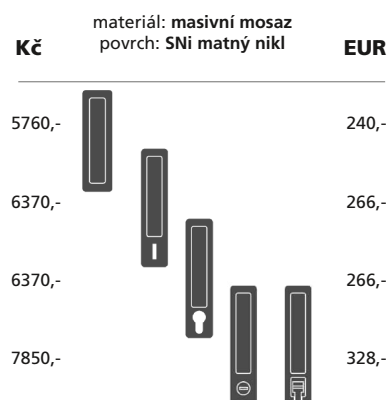

MAXIMAL SNI matný nikl  
výplň dřevo - dýha teak

**Mušle Maximal**

5760,- Kč  
240,- EUR

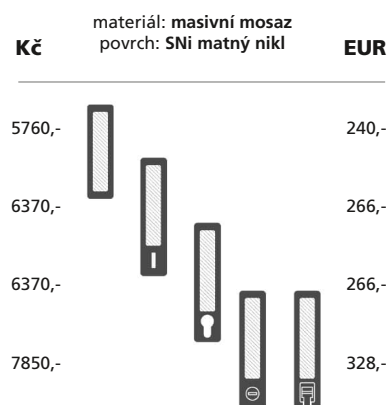

**Výplň mušle  
Maximal**

300,- Kč  
13,- EUR





	SNi		SNi - broušeno		Cr		Ms		TiN-C		TiN-B		TiN-K	
	cena	EAN	cena	EAN	cena	EAN	cena	EAN	cena	EAN	cena	EAN	cena	EAN
	Kč		Kč		Kč		Kč		Kč		Kč		Kč	
	€		€		€		€		€		€		€	
standard	5760,- 240,-	001211	5950,- 248,-	001228	6050,- 253,-	001235	6050,- 253,-	060836	7390,- 308,-	001242	7390,- 308,-	001259	7390,- 308,-	001266
dozická	6370,- 266,-	001280	6560,- 274,-	001297	6660,- 278,-	001303	6660,- 278,-	060843	8040,- 335,-	001310	8040,- 335,-	001327	8040,- 335,-	001334
cylindrická	6370,- 266,-	001358	6560,- 274,-	001365	6660,- 278,-	001372	6660,- 278,-	060850	8040,- 335,-	001389	8040,- 335,-	001396	8040,- 335,-	001402
WC / koupelna	7850,- 328,-	001426	8070,- 337,-	001433	8250,- 344,-	001440	8250,- 344,-	060867	9670,- 403,-	001457	9670,- 403,-	001464	9670,- 403,-	001471

Sada se zadlabacím zámkem v barvě podobné mušli (viz. barvy čela zámků na str. 362), protiplechem a krycí vaničkou.



SNi matný nikel



Cr lesklý chrom



TiN-C titan chrom mat



TiN-B titan braun mat



TiN-K titan černý mat



	SNi		SNi - broušeno		Cr		Ms		TiN-C		TiN-B		TiN-K	
	cena	EAN	cena	EAN	cena	EAN	cena	EAN	cena	EAN	cena	EAN	cena	EAN
	Kč		Kč		Kč		Kč		Kč		Kč		Kč	
	€		€		€		€		€		€		€	
standard	5760,- 240,-	001495	5950,- 248,-	001501	6050,- 253,-	001518	6050,- 253,-	060911	7390,- 308,-	001525	7390,- 308,-	001532	7390,- 308,-	001549
dozická	6370,- 266,-	001563	6560,- 274,-	001570	6660,- 278,-	001587	6660,- 278,-	060928	8040,- 335,-	001594	8040,- 335,-	001600	8040,- 335,-	001617
cylindrická	6370,- 266,-	001631	6560,- 274,-	001648	6660,- 278,-	001655	6660,- 278,-	060935	8040,- 335,-	001662	8040,- 335,-	001679	8040,- 335,-	001686
WC / koupelna	7850,- 328,-	001709	8070,- 337,-	001716	8250,- 344,-	001723	8250,- 344,-	060942	9670,- 403,-	001730	9670,- 403,-	001747	9670,- 403,-	001754

	cena	EAN
	Kč	
	€	
dřevo	300,- 13,-	001778
kov	300,- 13,-	001785
kůže	400,- 17,-	001792
efekt „sklo“	400,- 17,-	001808
RAL barvy	440,- 19,-	022506

Sada se zadlabacím zámkem v barvě podobné mušli (viz. barvy čela zámků na str. 362), protiplechem a krycí vaničkou.

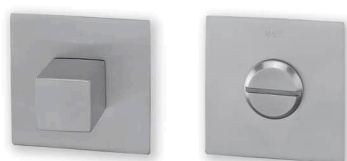
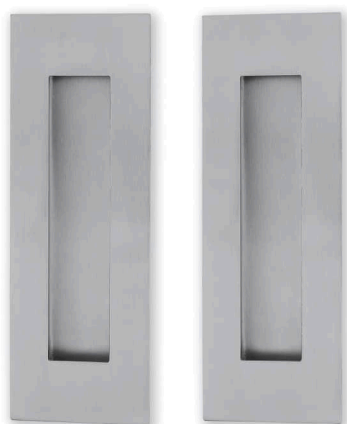

**Mušle Entero II**

730,- Kč  
31,- EUR

materiál: nerezová ocel  
Kč povrch: NRz nerez - broušeno EUR

730,-		31,-
2190,-		92,-

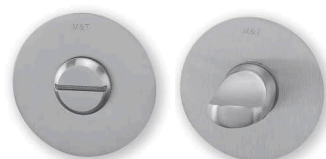
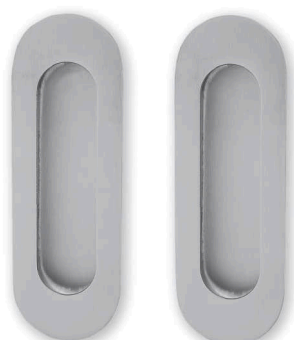

**Mušle Nova**

440,- Kč  
19,- EUR

materiál: nerezová ocel  
Kč povrch: NRz nerez - broušeno EUR

440,-		19,-
1740,-		73,-



**Boční úchyt Entero II**

300,- Kč  
13,- EUR

materiál: nerezová ocel  
Kč povrch: NRz nerez - broušeno EUR

300,-		13,-
-------	--	------



**Boční úchyt Entero**

300,- Kč  
13,- EUR

Kč EUR

300,-		13,-
-------	--	------



**Boční úchyt Nova**

260,- Kč  
11,- EUR

Kč EUR

260,-		11,-
-------	--	------

		NRz		K-industrial	
		cena	EAN	cena	EAN
150x50 mm	Kč €	ks 730,- 31,-	017816	ks 1450,- 61,-	034448
WC na plochých rozetách cena za pár včetně zámku	Kč €	pár 2190,- 92,-	017830	pár 3950,- 165,-	034455

Sada se zadlabacím zámkem v barvě podobné mušli (viz. barvy čela zámků na str. 362), protiplechem a krycí vaničkou.

		NRz		K-industrial	
		cena	EAN	cena	EAN
120x40 mm	Kč €	ks 440,- 19,-	017854	ks 1170,- 49,-	034462
WC Burak na plochých rozetách cena za pár včetně zámku	Kč €	pár 1740,- 73,-	017878	pár 3220,- 135,-	034479

Sada se zadlabacím zámkem v barvě podobné mušli (viz. barvy čela zámků na str. 362), protiplechem a krycí vaničkou.

		NRz		K-industrial	
		cena / ks	EAN	cena / ks	EAN
	Kč €	300,- 13,-	037555	550,- 23,-	037562

		SNI		Cr		TiN-K		K-industrial	
		cena / ks	EAN	cena / ks	EAN	cena / ks	EAN	cena / ks	EAN
	Kč €	300,- 13,-	17894	300,- 13,-	17900	550,- 23,-	093612	550,- 23,-	145144

		SNI		Cr		TiN-K		K-industrial	
		cena / ks	EAN	cena / ks	EAN	cena / ks	EAN	cena / ks	EAN
	Kč €	260,- 11,-	082197	260,- 11,-	087321	520,- 22,-	087338	520,- 22,-	145151

## Úchyt PUSH

Univerzální minimalistický úchyt s použitím na posuvné dveře jako boční úchyt, nebo na dřevěné obložení stěn jako věšáček.

PUSH vyniká svým elegantním ovládním a nenápadným čistým vzhledem.





PUSH se k dveřnímu křídlu přisazuje a přečnává pouhých 2,5 mm nad povrch dveří s plynulým zkosením na 0,5 mm. Úplně zapuštění nedoporučujeme.

Montáž se provádí pomocí silného magnetu. U jednostranných dveří, nebo obložení stěn lze montovat pomocí šroubků skrz materiál.



### Úchyt PUSH

820,- Kč  
 35,- EUR

Kč	materiál: masivní mosaz povrch: SNi matný nikl	EUR
820,-		35,-
880,-		37,-
890,-		38,-
930,-		39,-

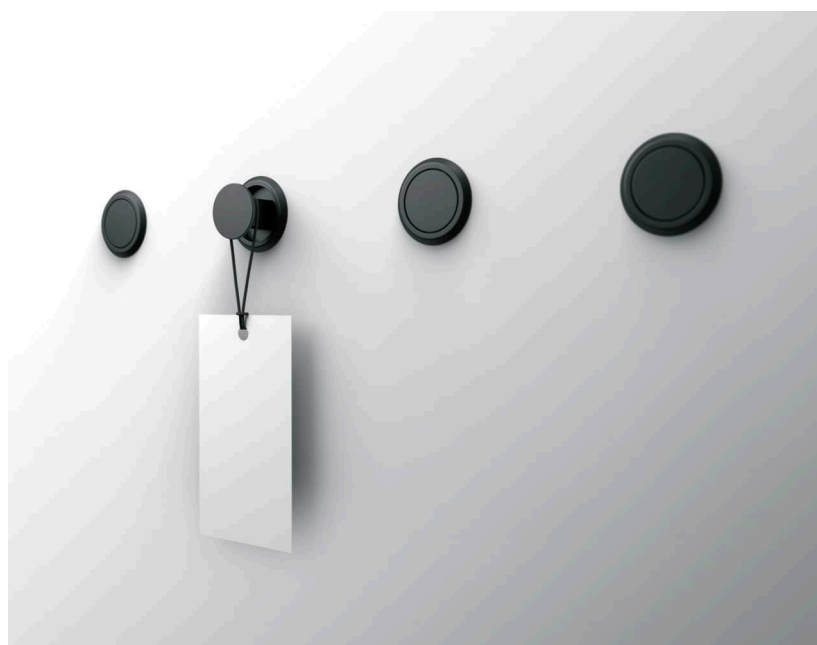

		SNI		TiN-K	
		cena	EAN	cena	EAN
kulatý	Kč €	820,- 35,-	132724	1080,- 45,-	132762
kulatý + magnet	Kč €	880,- 37,-	132731	1120,- 47,-	132779
hrnatý	Kč €	890,- 38,-	132748	1140,- 48,-	132786
hrnatý + magnet	Kč €	930,- 39,-	132755	1190,- 50,-	132793





Příbuzný sortiment

Kliky a zámky na skleněné dveře



Panty na skleněné dveře



Mušle na posuvné dveře



Madla dlouhá



Posuvný systém MINIMA pro dřevěné a skleněné dveře



Madla a koule na skleněné a dřevěné dveře





## Mušle Minimal / Maximal na skleněné posuvné dveře

Materiál: masivní mosaz   
 Povrchy: SNI, Cr, SNI-broušeno, TiN-C, TiN-B, TiN-K, Ms, Ms-L, zakázkově TiN-A   
 více info na [www.kliky-mt.cz/manufaktura/barvy-povrchy](http://www.kliky-mt.cz/manufaktura/barvy-povrchy)

Mušle Minimal / Maximal na skleněné dveře mají jedinečnost v barevnostní nabídce povrchových úprav. U žádné další firmy nenajdete v nabídce produkty na skleněné dveře, které lze barevně a designově sladit s produkty na dřevěné dveře. Využijte výjimečnosti mušlí Minimal / Maximal a sladte si interiér do posledního detailu.

**MINIMAL TIN-K** titan černý mat

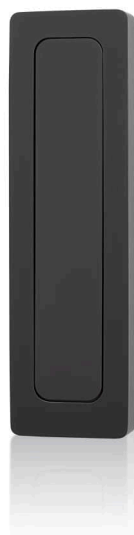

**MAXIMAL Cr** lesklý chrom + výplň sklo - bílá glanz

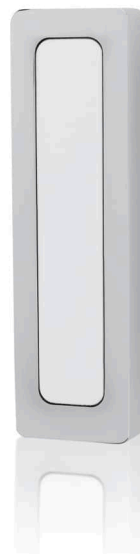

### konstrukční varianty

- pro montáž na tl. skla 8-10 mm
- tloušťku skla je potřeba specifikovat
- velmi rychlá a jednoduchá montáž
- výkresy vrtání ve specializovaném katalogu M&T GLASS, nebo na [www.kliky-mt.cz](http://www.kliky-mt.cz)
- záruka 3 roky, titany 15 let

roky **3 garance** let **15 garance**

Ochranné známky – registrované značky



**MINIMAL®**  
**MAXIMAL®**

Chráněné průmyslové vzory mušle



**MINIMAL**  
**MAXIMAL**

Patent



Konstrukce a systém tlačných pružin u mušlí Minimal / Maximal





SNi matný nikel

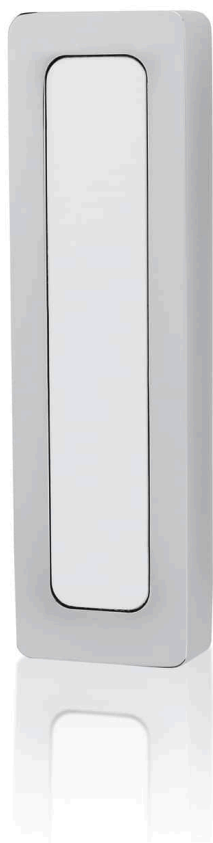

Cr lesklý chrom

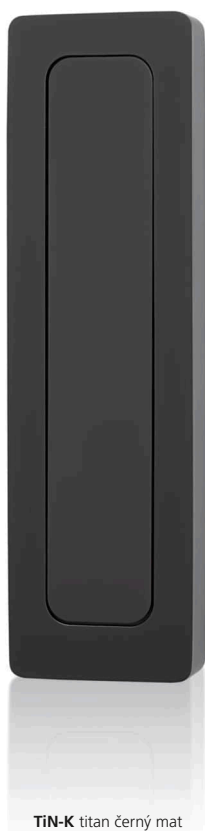

TiN-K titan černý mat

**Mušle na sklo**

**Minimal**

4960,-

**Maximal**

4960,-

4960,- Kč  
207,- EUR

**Výplň mušle  
Maximal**

300,- Kč  
13,- EUR

materiál: masivní mosaz  
povrch: SNi matný nikel

Kč

EUR

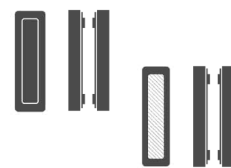

207,-

207,-



**Maximal Cr** lesklý chrom + výplň efekt „sklo“ - bílá glanz



	Sni		Sni - broušeno		Cr		Ms		TiN-C		TiN-B		TiN-K		
	cena	EAN	cena	EAN	cena	EAN	cena	EAN	cena	EAN	cena	EAN	cena	EAN	
	Kč		Kč		Kč		Kč		Kč		Kč		Kč		
Minimal	€	4960,- 207,-	002522	5020,- 210,-	002539	5130,- 214,-	002546	5130,- 214,-	060997	6440,- 269,-	002553	6440,- 269,-	002560	6440,- 269,-	002577
Maximal	€	4960,- 207,-	002591	5020,- 210,-	002607	5130,- 214,-	002614	5130,- 214,-	061000	6440,- 269,-	002621	6440,- 269,-	002638	6440,- 269,-	002645

		cena	EAN
		pár	
dřevo	Kč €	300,- 13,-	001778
kov	Kč €	300,- 13,-	001785
kůže	Kč €	400,- 17,-	001792
efekt „sklo“	Kč €	400,- 17,-	001808
RAL barvy	Kč €	440,- 19,-	022506



TiN-B titan braun mat



TiN-C titan chrom mat



Sni matný nikel - broušeno



Příbuzný sortiment

Rozetové kování



Panty na skleněné dveře



Mušle Minimal / Maximal  
na skleněné posuvné dveře



Madla dlouhá



Posuvný systém MINIMA  
pro dřevěné a skleněné dveře



Madla a koule na skleněné  
a dřevěné dveře



## Kliky a zámky na skleněné dveře

Materiál: masivní mosaz

Povrchy: SNI, Cr, SNI-broušeno, TiN-C, TiN-B, TiN-K, Ms, Ms-A, Ms-L, K-industrial, zakázkově TiN-A  
více info na [www.kliky-mt.cz/manufaktura/barvy-povrchy](http://www.kliky-mt.cz/manufaktura/barvy-povrchy)

Produkce zámků a klik M&T na skleněné dveře je jasnou výzvou pro příznivce pokročilého designu. V nabídce najdete kování vždy ve stejném designu a několika odstínech povrchové úpravy včetně pantů na sklo, což představuje naprostý unikát. Podobnou variabilitu nenajdete nikde jinde - u žádného výrobce nebo dovozce kování. Objevte maximální výhody této nabídky a svůj projekt dovedte do dokonalosti.

MINI



ENTERO



MINIMAL



TRINITY



### Varianty provedení

Standard

Standard

Standard

Standard

WC

WC

WC

WC

Protikus na dvoukřídlé dveře

Protikus na dvoukřídlé dveře

Protikus na dvoukřídlé dveře

Cylindrický

Cylindrický

### konstrukční varianty, materiálové provedení

- pro montáž na tl. skla 8-10 mm
- tloušťku skla je potřeba specifikovat
- výkresy vrtání ve specializovaném katalogu M&T GLASS nebo na [www.kliky-mt.cz](http://www.kliky-mt.cz)
- zámky Minimal a Maximal jsou s kompletní variabilitou povrchů a výplní jako u klik na dřevěné dveře
- řady zámků Mini, Entero, Trinity je možno kombinovat s jakoukoliv rukojetí z masivní mosazi z produkce M&T
- záruka 3 roky, titany 15 let

roky **3 garance** | let **15 garance**

### Ochranné známky – registrované značky



ENTERO®  
MINIMAL®  
MAXIMAL®  
MINI®

### Chráněné průmyslové vzory klik



veškeré chráněné designy klik M&T

zámků na sklo

MINIMAL  
MAXIMAL





**TiN-C** titan chrom mat  
klika Sogut

**Zámek Entero**

6690,- Kč  
279,- EUR



**SNi** matný nikl cylindrický  
klika Mimolimit + teak



**Cr** lesklý chrom WC  
klika Terry

**Kliky-rukojeti  
k zámkům na sklo**



**TiN-K** titan černý mat  
klika Mimolimit + jilm

**Kliky-rukojeti  
k zámkům na sklo**

**KČ** materiál: masivní mosaz  
povrch: SNi matný nikl **EUR**

6690,-		279,-
6770,-		283,-
7770,-		324,-
7860,-		328,-

**KČ** materiál: masivní mosaz  
povrch: SNi matný nikl broušeno **EUR**

2500,-	Maya 	105,-
2350,-	Toro 	98,-
2350,-	Tukan 	98,-
2350,-	Mimolimit 	98,-

**KČ** materiál: masivní mosaz  
povrch: SNi matný nikl broušeno **EUR**

2110,-	Entry 	88,-
1810,-	Trinity 	76,-
1950,-	My 	82,-
1950,-	Terry 	82,-



		SNI		SNI - broušeno		Cr		Ms		TiN-C		TiN-K		TiN-B		K-industrial	
		cena	EAN	cena	EAN	cena	EAN	cena	EAN	cena	EAN	cena	EAN	cena	EAN	cena	EAN
standard	Kč €	6690,- 279,-	87750	6690,- 279,-	90736	7350,- 307,-	87675	7350,- 307,-	061031	8360,- 349,-	87835	8710,- 363,-	87798	9030,- 377,-	90774	8710,- 363,-	137859
cylindrický	Kč €	6770,- 283,-	87767	6770,- 283,-	90743	7450,- 311,-	87682	7450,- 311,-	061048	8450,- 353,-	87842	8770,- 366,-	87804	9100,- 380,-	90781	8770,- 366,-	137866
WC	Kč €	7770,- 324,-	87774	7770,- 324,-	90750	8440,- 352,-	87699	8440,- 352,-	061055	9450,- 394,-	87859	9770,- 408,-	87811	10110,- 422,-	90798	9770,- 408,-	137873
protikus	Kč €	7860,- 328,-	87781	7860,- 328,-	90767	8610,- 359,-	87705	8610,- 359,-	061062	9720,- 405,-	87866	10040,- 419,-	87828	10380,- 433,-	90804	10040,- 419,-	137880

Pro tl. dveří 10 mm jsou v případě potřeby připraveny zámky se sníženou/užší střílkou o 2 mm... EAN 068498 příplatek ke katalogové ceně zámku + 680 Kč bez další slevy.



SNI matný nikl + protikus  
klicka Entero

		SNI - broušeno		Ms		TiN-C		TiN-K		TiN-B	
		cena / pár	EAN	cena / pár	EAN	cena / pár	EAN	cena / pár	EAN	cena / pár	EAN
Maya	Kč €	2500,- 105,-	19041	2570,- 108,-	061116	2970,- 124,-	19058			3130,- 131,-	19065
Toro	Kč €	2350,- 98,-	19119	2420,- 101,-	061123	2800,- 117,-	19126			2970,- 124,-	19133
Tukan	Kč €	2350,- 98,-	19140	2420,- 101,-	061130	2800,- 117,-	19157			2970,- 124,-	19164
Mimolimit	Kč €	2350,- 98,-	19072	2280,- 95,-	061147	2800,- 117,-	19089	2970,- 124,-	19096	2970,- 124,-	19102

Kliky - rukojeti jsou připraveny se zvýhodněnou cca 50% slevou oproti klikám s rozetou. Uvedená cena je za pár klik - rukojetí.  
Všechny typy klik je možné kombinovat se všemi typy zámků (mimo samostatnou kolekci Minimal / Maximal).



		SNI - broušeno		Cr		Ms		TiN-C		TiN-K	
		cena / pár	EAN	cena / pár	EAN	cena / pár	EAN	cena / pár	EAN	cena / pár	EAN
Entry	Kč €	2110,- 88,-	12912	2180,- 91,-	12905	2180,- 91,-	061192	2500,- 105,-	12929	2660,- 111,-	12936
Trinity	Kč €	1810,- 76,-	12950	1860,- 78,-	12943	1860,- 78,-	061208	2190,- 92,-	12967	2350,- 98,-	12974
My	Kč €	1950,- 82,-	12998	2030,- 85,-	12981	2030,- 85,-	061215	2350,- 98,-	18983	2500,- 105,-	18990
Terry	Kč €	1950,- 82,-	19010	2030,- 85,-	19003	2030,- 85,-	061222	2350,- 98,-	19027	2500,- 105,-	19034



**Cr** lesklý chrom  
klika Mini-T

**Zámek Mini**

5520,- Kč  
230,- EUR

Kč	materiál: masivní mosaz povrch: SNi matný nikel	EUR
5520,-		230,-
6580,-		275,-
6690,-		279,-



**TiN-K** titan černý mat  
klika Mimolimit Alu kompakt



**SNi-broušeno** matný nikel broušeno  
klika Lara

**Kliky-rukojeti  
k zámkům na sklo**

Kč	materiál: masivní mosaz povrch: SNi matný nikel	EUR
1100,-	Mini-V 	46,-
870,-	Mini-C 	37,-
1020,-	Mini-T 	43,-
950,-	Mini-S 	40,-



**TiN-K** titan černý mat  
klika Mini-V

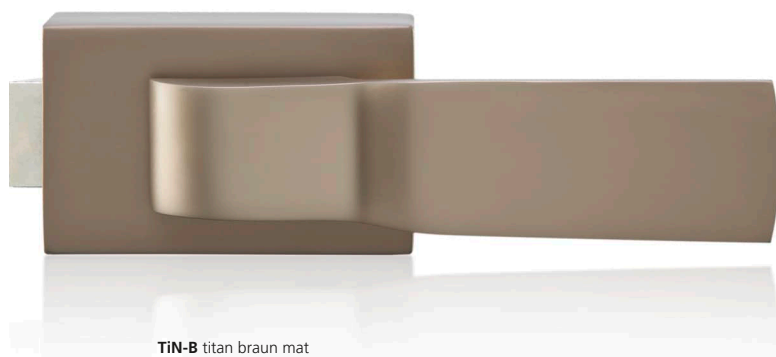

**TiN-B** titan braun mat  
klika Tukan





		SNI		SNI - broušeno		Cr		Ms		TiN-C		TiN-K		TiN-B	
		cena	EAN	cena	EAN	cena	EAN	cena	EAN	cena	EAN	cena	EAN	cena	EAN
standard	Kč €	5520,- 230,-	87934	5520,- 230,-	90811	6030,- 252,-	87873	6030,- 252,-	061277	7200,- 300,-	87996	7530,- 314,-	87965	7860,- 328,-	88023
WC	Kč €	6580,- 275,-	87941	6580,- 275,-	90828	7080,- 295,-	87880	7080,- 295,-	061284	8260,- 345,-	88009	8580,- 358,-	87972	8940,- 373,-	88030
protikus	Kč €	6690,- 279,-	87958	6690,- 279,-	90835	7200,- 300,-	87897	7200,- 300,-	061291	8540,- 356,-	88016	8860,- 370,-	87989	9210,- 384,-	88047

Pro tl. dveří 10 mm jsou v případě potřeby připraveny zámky se sníženou/uzší střelkou o 2 mm... EAN 068498 příplatek ke katalogové ceně zámku + 680 Kč bez další slevy.



SNI matný nikl + protikus  
klika Mini-C



		SNI		Cr		Ms		TiN-K	
		cena / pár	EAN	cena / pár	EAN	cena / pár	EAN	cena / pár	EAN
Mini-V	Kč €	1100,- 46,-	19171	1180,- 50,-	19188	1180,- 50,-	061338	1420,- 60,-	19195
Mini-C	Kč €	870,- 37,-	19201	950,- 40,-	19218	950,- 40,-	061345	1180,- 50,-	19225
Mini-T	Kč €	1020,- 43,-	19232	1100,- 46,-	19249	1100,- 46,-	061352	1330,- 56,-	19256
Mini-S	Kč €	950,- 40,-	19263	1020,- 43,-	19270	1020,- 43,-	061369	1260,- 53,-	19287

Klíky - rukojeti jsou připraveny se zvýhodněnou cca 50% slevou oproti klikám s rozetou. Uvedená cena je za pár klik - rukojetí. Všechny typy klik je možné kombinovat se všemi typy zámků (mimo samostatnou kolekci Minimal / Maximal).



SNI matný nikl  
západka s podlahovým pouzdem

západka + protikus do zárubně

### Západka k dvoukřídlým dveřím

Západka k dvoukřídlým dveřím		SNI		SNI - br.		Cr		Ms		TiN-C		TiN-K		TiN-B	
		cena / ks	EAN	cena / ks	EAN	cena / ks	EAN	cena / ks	EAN	cena / ks	EAN	cena / ks	EAN	cena / ks	EAN
pro tl. skla 8-10 mm bez vrtání skla	Kč €	5120,- 214,-	89440	5120,- 214,-	90842	5120,- 214,-	89457	5120,- 214,-	078954	5940,- 248,-	89471	5940,- 248,-	89464	5940,- 248,-	89488

Dveřní západka je univerzální pro tl. skla 8 - 10 mm bez vrtání skla. Součástí dodávky je podlahové pouzdro pro uchycení do podlahy.

Protikus do zárubně		SNI		SNI - br.		Cr		Ms		TiN-C		TiN-K		TiN-B	
		cena / ks	EAN	cena / ks	EAN	cena / ks	EAN	cena / ks	EAN	cena / ks	EAN	cena / ks	EAN	cena / ks	EAN
	Kč €	510,- 22,-	078879	510,- 22,-	078886	600,- 25,-	078893	600,- 25,-	078930	680,- 29,-	078916	680,- 29,-	078909	680,- 29,-	078923

Při montáži západky na horní část dveřního křídla s fixací do horní zárubně je nutno přibojednat protikus do zárubně.



TiN-B titan braun mat + výplň dřevo - dýha 3D dub  
klika Maximal

**Zámek na sklo**

**Minimal**

6670,-



278,-

7730,-



323,-

**Maximal**

7150,-



298,-

7150,- Kč

298,- EUR

materiál: masivní mosaz  
povrch: SNi matný nikl



SNi matný nikl  
klika Minimal

**Výplň zámku na sklo**

**Maximal**

440,- Kč

19,- EUR



**Kliky**

**Minimal**

3690,-



154,-

**Maximal**

4100,-

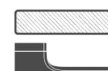

171,-

4100,- Kč

171,- EUR

materiál: masivní mosaz  
povrch: SNi matný nikl



Cr lesklý chrom  
klika Minimal

**Výplň kliky**

**Maximal**

200,- Kč

8,4 EUR



**Protikus na sklo**

**Minimal**

6670,-



278,-

**Maximal**

7150,-



298,-

7150,- Kč

298,- EUR

materiál: masivní mosaz  
povrch: SNi matný nikl

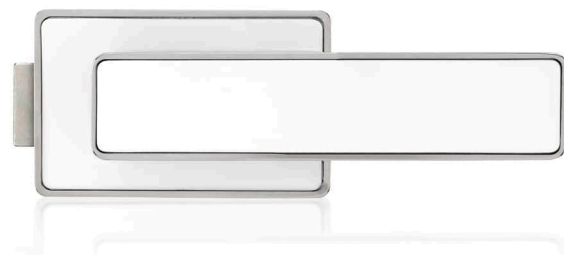

Cr lesklý chrom + výplň efekt „sklo“ - bílá glanz  
klika Maximal

**Výplň protikusu na sklo**

**Maximal**

440,- Kč

19,- EUR





	Sni		Sni - broušeno		Cr		Ms		TiN-C		TiN-B		TiN-K		
	cena	EAN	cena	EAN	cena	EAN	cena	EAN	cena	EAN	cena	EAN	cena	EAN	
	pár		pár		pár		pár		pár		pár		pár		
Minimal standard	Kč €	6670,- 278,-	000788	6830,- 285,-	000795	7000,- 292,-	000801	7000,- 292,-	061413	7830,- 327,-	000818	7830,- 327,-	000825	7830,- 327,-	000832
Minimal WC	Kč €	7730,- 323,-	080797	7900,- 330,-	080803	8060,- 336,-	080810	8060,- 336,-	080827	8900,- 371,-	080841	8900,- 371,-	080865	8900,- 371,-	080858
Maximal standard	Kč €	7150,- 298,-	000856	7320,- 305,-	000863	7490,- 313,-	000870	7490,- 313,-	061420	8280,- 345,-	000887	8280,- 345,-	000894	8280,- 345,-	000900

Pro tl. dveří 10 mm jsou v případě potřeby připraveny zámkové se sníženou/užší střílkou o 2 mm... EAN 068498 příplatek ke katalogové ceně zámkové + 680 Kč bez další slevy.

	cena	EAN		cena	EAN		
	pár			pár			
dřevo	Kč €	440,- 19,-	000924	kůže	Kč €	520,- 22,-	000948
kov	Kč €	440,- 19,-	000931	efekt „sklo“	Kč €	520,- 22,-	000955

Kompletní sada **Minimal standard** na skleněné dveře se skládá ze zámkové na sklo a klik s rozetou (tj. klika stejná jako u dřevěných dveří, která se i s rozetou montuje na zámeček na sklo).



	Sni		Sni - broušeno		Cr		Ms		TiN-C		TiN-B		TiN-K		
	cena	EAN	cena	EAN	cena	EAN	cena	EAN	cena	EAN	cena	EAN	cena	EAN	
	pár		pár		pár		pár		pár		pár		pár		
Minimal klika / klika	Kč €	3690,- 154,-	000009	3800,- 159,-	000016	3990,- 167,-	000023	3990,- 167,-	055115	4930,- 206,-	000030	4930,- 206,-	000047	4930,- 206,-	000054
Maximal klika / klika	Kč €	4100,- 171,-	000214	4180,- 175,-	000221	4400,- 184,-	000238	4400,- 184,-	062632	5320,- 222,-	000245	5320,- 222,-	000252	5320,- 222,-	000269

	cena	EAN	
	ks		
dřevo	Kč €	200,- 8,4	000429
kov	Kč €	200,- 8,4	000436
kůže	Kč €	300,- 13,-	000443
efekt „sklo“	Kč €	300,- 13,-	000450
RAL barvy	Kč €	300,- 13,-	022346

Kompletní sada **Minimal WC** na skleněné dveře se skládá ze zámkové na sklo a klik Minimal s Al rozetou (tj. klika stejná jako na hliníkové a ocelové dveře, která se i s rozetou montuje na zámeček na sklo), str. 114 – 115.



	Sni		Sni - broušeno		Cr		Ms		TiN-C		TiN-B		TiN-K		
	cena	EAN	cena	EAN	cena	EAN	cena	EAN	cena	EAN	cena	EAN	cena	EAN	
	pár		pár		pár		pár		pár		pár		pár		
Minimal	Kč €	6670,- 278,-	000962	6830,- 285,-	000979	7000,- 292,-	000986	7000,- 292,-	061451	7830,- 327,-	000993	7830,- 327,-	001006	7830,- 327,-	001013
Maximal	Kč €	7150,- 298,-	001037	7320,- 305,-	001044	7490,- 313,-	001051	7490,- 313,-	061468	8280,- 345,-	001068	8280,- 345,-	001075	8280,- 345,-	001082

	cena	EAN	
	pár		
dřevo	Kč €	440,- 19,-	001105
kov	Kč €	440,- 19,-	001112
kůže	Kč €	520,- 22,-	001129
efekt „sklo“	Kč €	520,- 22,-	001136



Sni matný nikl + protikus klika Minimal



**SNi-broušeno** matný nikl broušeno  
klíka Trinity

### Zámek Trinity

8860,- Kč  
370,- EUR

Kč	materiál: masivní mosaz povrch: SNi matný nikl	EUR
8860,-		370,-
8950,-		373,-
9940,-		415,-

### Klíky-rukojeti k zámkům na sklo



**TiN-B** titan braun mat  
klíka Toro

Kč	materiál: masivní mosaz povrch: SNi matný nikl	EUR
780,-	Fábi	33,-
700,-	Burak	30,-
820,-	Garanti	35,-
700,-	Mia	30,-
590,-	Cesan	25,-
910,-	Lusy	38,-
780,-	Andy	33,-
910,-	Deny	38,-
860,-	Kemer	36,-
700,-	Meclis	30,-
1150,-	Mondeo	48,-
930,-	Maty	39,-
1110,-	Sogut	47,-
1300,-	Cherez	55,-
1340,-	Entero	56,-
1230,-	Lara	52,-



		SNI		SNI - broušeno		Cr		Ms		TiN-B	
		cena	EAN	cena	EAN	cena	EAN	cena	EAN	cena	EAN
standard	Kč €	8860,- 370,-	081275	8860,- 370,-	87590	9380,- 391,-	87552	9380,- 391,-	061499	11220,- 468,-	87613
cyklindrický	Kč €	8950,- 373,-	081282	8950,- 373,-	90217	9460,- 395,-	90200	9460,- 395,-	061505	11290,- 471,-	90224
WC	Kč €	9940,- 415,-	081299	9940,- 415,-	87606	10440,- 438,-	87569	10440,- 435,-	061512	12290,- 513,-	87620

Pro tl. dveří 10 mm jsou v případě potřeby připraveny zámky se sníženou/užší střílkou o 2 mm... EAN 068498 příplatek ke katalogové ceně zámku + 680 Kč bez další slevy.



		SNI		SNI - broušeno		Cr		Ms		TiN-C		TiN-K		TiN-B	
		cena / pár	EAN	cena / pár	EAN	cena / pár	EAN	cena / pár	EAN	cena / pár	EAN	cena / pár	EAN	cena / pár	EAN
Fábi	Kč €	780,- 33,-	11007			830,- 35,-	11014	830,- 35,-	061550	1100,- 46,-	11021	1260,- 53,-	11038		
Burak	Kč €	700,- 30,-	11243			770,- 33,-	11250	770,- 33,-	061567	1020,- 43,-	11267	1190,- 50,-	11274		
Garanti	Kč €	820,- 35,-	11045			880,- 37,-	11052	880,- 37,-	061574	1150,- 48,-	11069	1300,- 55,-	11076		
Mia	Kč €	700,- 30,-	11281			770,- 33,-	11298	770,- 33,-	061581	1020,- 43,-	11304	1190,- 50,-	11311		
Cesan	Kč €	590,- 25,-	11083			630,- 27,-	11090	630,- 27,-	061598	910,- 38,-	11106	1070,- 45,-	11113		
Lusy	Kč €	910,- 38,-	11328			980,- 41,-	11335	980,- 41,-	061604	1230,- 52,-	11342	1390,- 58,-	11359		
Andy	Kč €	780,- 33,-	11120			830,- 35,-	11137	830,- 35,-	061611	1100,- 46,-	11144	1260,- 53,-	11151		
Deny	Kč €	910,- 38,-	11373			980,- 41,-	11380	980,- 41,-	061628	1230,- 52,-	11397	1390,- 58,-	11403		
Kemer	Kč €	860,- 36,-	11168			920,- 39,-	11175	920,- 39,-	061635	1190,- 50,-	11182	1360,- 57,-	11199		
Meclis	Kč €	700,- 30,-	11427			770,- 33,-	11434	770,- 33,-	061642	1020,- 43,-	11441	1190,- 50,-	11458		
Mondeo	Kč €	1150,- 48,-	11205			1210,- 51,-	11212	1210,- 51,-	061659	1460,- 61,-	11229	1620,- 68,-	11236		
Maty	Kč €	930,- 39,-	12646			1010,- 43,-	12653	1010,- 43,-	061666	1260,- 53,-	12660	1450,- 61,-	12677		
Sogut	Kč €	1110,- 47,-	12684			1180,- 50,-	12691	1180,- 50,-	061673	1450,- 61,-	12707	1610,- 68,-	12714		
Cherez	Kč €	1300,- 55,-	12752			1360,- 57,-	12769	1360,- 57,-	061680	1710,- 72,-	12776	1850,- 78,-	12783		
Entero	Kč €	1340,- 56,-	12790	1390,- 58,-	12813	1450,- 61,-	12806	1450,- 61,-	061697	1770,- 74,-	12820	1940,- 81,-	12837	1940,- 81,-	12844
Lara	Kč €			1230,- 52,-	12875	1290,- 54,-	12868	1290,- 54,-	062625	1620,- 68,-	12882	1770,- 74,-	12899		

Klíky - rukojeti jsou připraveny se zvýhodněnou cca 50% slevou oproti klikám s rozetou. Uvedená cena je za pár klik - rukojetí. Všechny typy klik je možné kombinovat se všemi typy zámků (mimo samostatnou kolekci Minimal / Maximal).



Příbuzný sortiment

Kliky a zámky na skleněné dveře



Madla a koule na skleněné a dřevěné dveře



Madla dlouhá

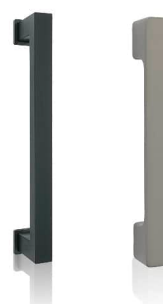

## Panty na skleněné dveře

Materiál: masivní mosaz, hliník

Povrchy: SNI, Cr, SNI-broušeno, TiN-C, TiN-B, TiN-K, Ms, Ms-L, Ms-A, Ms-K, K-industrial, zakázkově TiN-A  
více info na [www.kliky-mt.cz/manufaktura/barvy-povrchy](http://www.kliky-mt.cz/manufaktura/barvy-povrchy)

Panty M&T na skleněné dveře doplňují nabídku zámků v designech, které dokonale dotváří jedinečnost interiéru. Pant Trinity a hranatý pant Entero jsou připraveny k zámkům ve všech typech povrchových úprav, což u těchto setů na skleněné dveře představuje jasnou výzvu pro milovníky pokročilého designu.

Entero **TiN-K** titan černý mat



Trinity **SNI** matný nikl



### konstrukční varianty

- pro montáž na tl skla 8-10 mm
- tloušťku skla je potřeba specifikovat
- výkresy vrtání ve specializovaném katalogu M&T GLASS nebo na [www.kliky-mt.cz](http://www.kliky-mt.cz)
- záruka 3 roky, titany 15 let

roky **3 garance** let **15 garance**

Ochranné známky – registrované značky

**ENTERO®**



Více informací v kompletním katalogu kování na sklo M&T GLASS

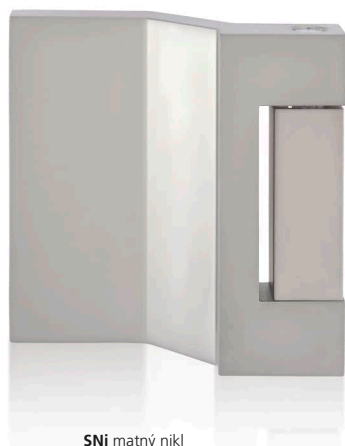

SNI matný nikel



TiN-K titan černý mat

**Kč** materiál: masivní mosaz povrch: SNI matný nikel **EUR**

**Pant Entero**

4990,-



208,-

4990,- Kč  
208,- EUR

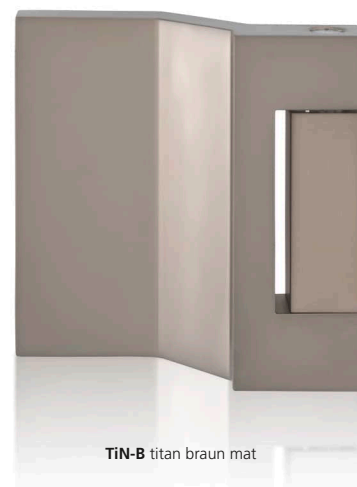

TiN-B titan braun mat

**Kč** materiál: masivní mosaz povrch: SNI matný nikel **EUR**

**Pant Trinity**

6040,-



252,-

6040,- Kč  
252,- EUR



TiN-B titan braun mat



SNI matný nikel



TiN-C titan chrom mat





	SNI		SNI - broušeno		Cr		Ms		TiN-C		TiN-K		TiN-B	
	cena / pár	EAN	cena / pár	EAN	cena / pár	EAN	cena / pár	EAN	cena / pár	EAN	cena / pár	EAN	cena / pár	EAN
Kč €	4990,- 208,-	88184	4990,- 208,-	90439	6020,- 251,-	88160	6020,- 251,-	061888	6670,- 278,-	88207	7000,- 292,-	88191	7330,- 306,-	88214

Součástí pantů a v ceně sady pantů je střední díl pantu a vložka závěsu.



SNI matný nikl - broušeno



Cr lesklý chrom



TiN-C titan chrom mat



	SNI		SNI - broušeno		Cr		Ms		TiN-C		TiN-K		TiN-B	
	cena / pár	EAN	cena / pár	EAN	cena / pár	EAN	cena / pár	EAN	cena / pár	EAN	cena / pár	EAN	cena / pár	EAN
Kč €	6040,- 252,-	88122	6040,- 252,-	90422	7070,- 295,-	88108	7070,- 295,-	061901	7600,- 317,-	88146	7960,- 332,-	88139	8280,- 345,-	88153

Součástí pantů a v ceně sady pantů je střední díl pantu a vložka závěsu.



SNI matný nikl - broušeno



TiN-K titan černý mat



Cr lesklý chrom



Celý projekt - jeden design

Dveřní kliky NEREZ



Nerezové kliky, zámký a panty na skleněné dveře



Mušle na posuvné dveře



Okenní kliky 3 a 4 polohové



Štitové kování NEREZ



Madla dlouhá



Kování pro hliníkové a ocelové dveře, kování na branky



Bezpečnostní rozety



Madla a koule na skleněné a dřevěné dveře



## Nerezové kliky, zámky a panty na skleněné dveře

Materiál: nerezová ocel

Povrchy: NRz, TiN-K, K-industrial

Sety nerezových klik, zámků a pantů M&T doplňují komplexní nabídku nerezového programu vhodného do všech projektů s důrazem na perfektní funkčnost a dlouhodobou životnost. Nadstandardem této řady kování je možnost povlakování žadáným titanovým povrchem v černé barvě TiN-K. V tomto povrchu se jedná o vrcholnou řadu kování vhodnou do špičkových projektů.

Zámek Economy Objekt  
**TiN-K**



Zámek Mini  
**NRz** nerez



Pant Economy Objekt  
**NRz** nerez



Pant Entero  
**NRz** nerez



Varianty provedení

Standard



Standard



Cylindrický



WC



Protikus na dvoukřídlé  
dveře



konstrukční varianty, materiálové provedení

- pro montáž na tl. skla 8-10 mm
- tloušťku skla je potřeba specifikovat
- výkresy vrtání ve specializovaném katalogu M&T GLASS nebo na [www.kliky-mt.cz](http://www.kliky-mt.cz)
- zámek Economy nerez a Mini nerez je možno kombinovat s jakoukoliv rukojetí nerez z produkce M&T
- záruka 5 let, titany 15 let

5 let garance

15 let garance

Ochranné známky – registrované značky



**ENTERO®**  
**MINI®**

Chráněné průmyslové vzory klik



**MORGAN**  
**TECHNO**  
**ENTERO**  
**SENZA**  
**PROMO**  
**NOVA**



Více informací v kompletním katalogu kování na sklo M&T GLASS



NRz nerez - broušeno  
 klika Entero

**Zámek Economy Objekt**

9160,- Kč  
 382,- EUR

materiál: nerezová ocel  
 povrch: NRz nerez - broušeno

**KČ** **EUR**

9160,-  382,-

9220,-  385,-

10010,-  418,-

10340,-  431,-



TiN-K titan černý mat  
 klika Morgan



NRz nerez - broušeno cylindrický  
 klika Deny



NRz nerez - broušeno WC  
 klika Cesan

		Objekt nerez		Objekt titan		Objekt	
		NRz		TiN-K		K-industrial	
		cena / pár	EAN	cena / pár	EAN	cena / pár	EAN
standard	Kč €	9160,- 382,-	88092	11060,- 461,-	90385	11060,- 461,-	137699
cylindrický	Kč €	9220,- 385,-	90354	11130,- 464,-	90392	11130,- 464,-	137705
WC	Kč €	10010,- 418,-	90361	11910,- 497,-	90408	11910,- 497,-	137712
protikus	Kč €	10340,- 431,-	90378	12220,- 510,-	90415	12220,- 510,-	137729

Cena za set s panty Economy Objekt.

Pro tl. dveří 10 mm jsou v případě potřeby připraveny zámky se sníženou/uzší střílkou o 2 mm... EAN 068498 příplatek ke katalogové ceně zámku + 680 Kč bez další slevy.



NRz nerez - broušeno + protikus  
klíka Lusy

### Pant Economy Objekt



NRz nerez - broušeno



TiN-K titan černý mat



NRz nerez - broušeno  
klika Senza

**Zámek Mini**

6020,- Kč  
251,- EUR

materiál: nerezová ocel  
Kč povrch: NRz nerez - broušeno EUR

6020,-		251,-
7020,-		293,-
6950,-		290,-



TiN-K titan černý mat  
klika Morgan

**Kliky-rukojeti  
k zámkům na sklo**

370,- Kč  
16,- EUR

materiál: nerezová ocel  
Kč povrch: NRz nerez - broušeno EUR

370,-	Lusy	16,-
370,-	Deny	16,-
370,-	Meclis	16,-
550,-	Morgan	23,-
600,-	Jameson	25,-
760,-	Nova	32,-
670,-	Senza	28,-
760,-	Promo	32,-
970,-	Entero	41,-
760,-	Kvadra	32,-
760,-	Techno	32,-
510,-	Cesan	22,-

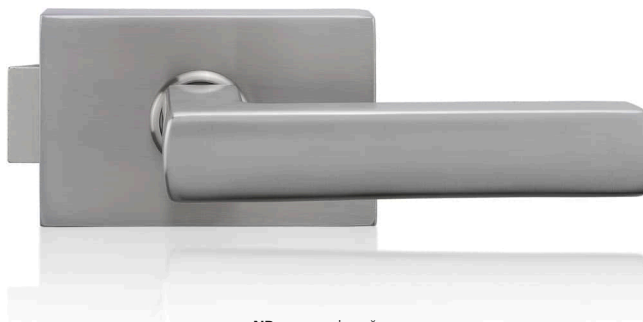

NRz nerez - broušeno  
klika Kvadra



NRz nerez - broušeno  
klika Promo



NRz nerez - broušeno  
protikus zámek Mini

		Objekt nerez		Objekt titan		Objekt K-industrial	
		NRz		TiN-K			
		cena / pár	EAN	cena / pár	EAN	cena / pár	EAN
standard	Kč €	6020,- 251,-	027532	9320,- 389,-	027549	9320,- 389,-	137736
Cena za set s 2 panty Entero.							
WC	Kč €	7020,- 293,-	080889	10340,- 431,-	080896	10340,- 431,-	137743
Cena za set s 2 panty Entero.							
protikus	Kč €	6950,- 290,-	066517	10260,- 428,-	066524	10260,- 428,-	137750
Cena za set s 2 panty Entero.							

Pro tl. dveří 10 mm jsou v případě potřeby připraveny zámky se sníženou/užší střelkou o 2 mm... EAN 068498 příplatek ke katalogové ceně zámku + 680 Kč bez další slevy.

		Objekt nerez		Objekt titan		Objekt K-industrial	
		NRz		TiN-K			
		cena / pár	EAN	cena / pár	EAN	cena / pár	EAN
Lusy	Kč €	370,- 16,-	11366	730,- 31,-	90484	730,- 31,-	137521
Deny	Kč €	370,- 16,-	11410	1040,- 44,-	90507	1040,- 44,-	137538
Meclis	Kč €	370,- 16,-	11465	1180,- 50,-	90460	1180,- 50,-	137545
Morgan	Kč €	550,- 23,-	12745	800,- 34,-	90453	800,- 34,-	137552
Jameson	Kč €	600,- 25,-	91283	1250,- 53,-	91290	1250,- 53,-	137569
Nova	Kč €	760,- 32,-	91306	1400,- 59,-	91313	1400,- 59,-	137576
Senza	Kč €	670,- 28,-	91320			1330,- 56,-	137583
Promo	Kč €	760,- 32,-	91344			1400,- 59,-	137590
Entero	Kč €	970,- 41,-	12851	1400,- 59,-	90491	1400,- 59,-	137606
Kvadra	Kč €	760,- 32,-	91368	1400,- 59,-	91375	1400,- 59,-	137613
Techno	Kč €	760,- 32,-	91382			1400,- 59,-	137620
Cesan	Kč €	510,- 22,-	15982	1330,- 56,-	90477	1330,- 56,-	137637

Kličky - rukojeti jsou připraveny se zvýhodněnou cca 50% slevou oproti klikám s rozetou. Uvedená cena je za pár klik - rukojetí. Všechny typy nerezových klik je možné kombinovat s oběma typy nerezových zámků.

## Pant Entero



NRz nerez - broušeno



TiN-K titan černý mat

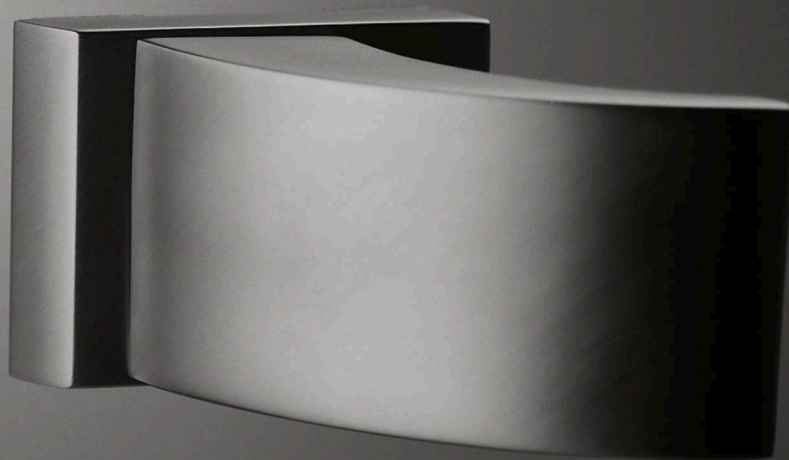

Příbuzný sortiment

Mušle Minimal / Maximal  
na skleněné posuvné dveře



Madla dlouhá



Posuvný systém MINIMA  
pro dřevěné a skleněné dveře





## Madla a koule na skleněné a dřevěné dveře

Materiál: masivní mosaz

Povrchy: SNI, Cr, SNI-broušeno, TiN-C, TiN-B, TiN-K, Ms, Ms-L, zakázkově TiN-A, TiN-S  
více info na [www.kliky-mt.cz/manufaktura/barvy-povrchy](http://www.kliky-mt.cz/manufaktura/barvy-povrchy)

Materiál: nerezová ocel

Povrchy: NRz, TiN-K, K-industrial

Všechny madla a koule M&T na skleněné dveře a dřevěné dveře lze barevnostně a designově sladit s ostatními produkty M&T, což dodává těmto výrobkům naprostou výjimečnost a nezastupitelnost při navrhování kvalitních interiérů.

### Madlo Mimolimit **TiN-K** + dřevina ořech



madla

Minimal, Mimolimit, Maya, Toro, Entry, Entero

### koule Maty **SNI** matný nikel



koule

Maty, Kemer

#### konstrukční varianty, materiálové provedení

- pro montáž na tl. skla 8-12 mm
- tloušťku skla je potřeba specifikovat
- výkresy vrtání ve specializovaném katalogu M&T GLASS nebo na [www.kliky-mt.cz](http://www.kliky-mt.cz)
- pro montáž na dřevěné dveře tl. 37-85 mm
- koule Maty a madla Entero lze dodat i ve variantě NRz
- záruka 3 roky, titany 15 let

roky **3 garance** let **15 garance**

#### Ochranné známky – registrované značky



**ENTERO®**  
**MIMOLIMIT®**  
**MINIMAL®**

#### Chráněné průmyslové vzory model



**MIMOLIMIT**  
**MINIMAL**  
**ENTERO**

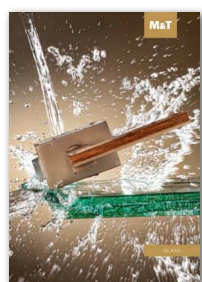



TiN-K titan černý mat + ořech



SNi matný nikl - broušeno + teak



SNi matný nikl - broušeno



SNi matný nikl - broušeno

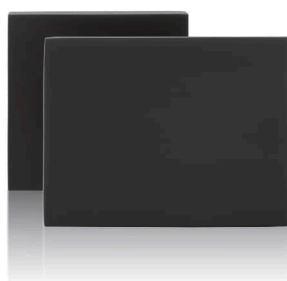

TiN-K titan černý mat



SNi matný nikl

### Madlo Mimolimit

4470,- Kč  
187,- EUR

### Madlo Maya

4470,- Kč  
187,- EUR

### Madlo Toro

4310,- Kč  
180,- EUR

### Madlo Entry

4310,- Kč  
180,- EUR

### Madlo Entero

3970,- Kč  
166,- EUR

### Madlo Minimal

4600,- Kč  
192,- EUR

materiál: masivní mosaz  
Kč povrch: SNi matný nikl broušeno EUR

4470,-		187,-
4630,-		193,-
4790,-		200,-
4790,-		200,-

4470,-		187,-
4630,-		193,-
4790,-		200,-
4790,-		200,-

materiál: masivní mosaz  
Kč povrch: SNi matný nikl EUR

4310,-		180,-
4440,-		185,-
4600,-		192,-
4600,-		192,-

4310,-		180,-
4440,-		185,-
4600,-		192,-
4600,-		192,-

3970,-		166,-
4140,-		173,-
4310,-		180,-
4310,-		180,-

4600,-		192,-
4760,-		199,-
4910,-		205,-
4910,-		205,-



		SNI - broušeno		Ms		TiN-C		TiN-K		TiN-B	
		cena / pár	EAN	cena / pár	EAN	cena / pár	EAN	cena / pár	EAN	cena / pár	EAN
tloušťka dveří	Kč	4470,-	32040	4520,-	061925	5090,-	32088	5400,-	32125	5400,-	34174
37 - 50 mm	€	187,-		189,-		213,-		225,-		225,-	
tloušťka dveří	Kč	4630,-	32057	4650,-	061932	5260,-	32095	5570,-	32132	5570,-	34181
51 - 68 mm	€	193,-		194,-		220,-		233,-		233,-	
tloušťka dveří	Kč	4790,-	32064	4810,-	061949	5400,-	32101	5720,-	32149	5720,-	34198
69 - 85 mm	€	200,-		201,-		225,-		239,-		239,-	
tloušťka dveří	Kč	4790,-	32071	4810,-	061956	5400,-	32118	5720,-	34167	5720,-	34204
8 - 12 mm sklo	€	200,-		201,-		225,-		239,-		239,-	

Cena madla bez dřeva, dřevěná část se objednává samostatně. Tabulka dřevin na str. 97.

tloušťka dveří	Kč	4470,-	34211	4520,-	062007	5090,-	34259			5400,-	34297
37 - 50 mm	€	187,-		189,-		213,-				225,-	
tloušťka dveří	Kč	4630,-	34228	4650,-	062014	5260,-	34266			5570,-	34303
51 - 68 mm	€	193,-		194,-		220,-				233,-	
tloušťka dveří	Kč	4790,-	34235	4810,-	062021	5400,-	34273			5720,-	34310
69 - 85 mm	€	200,-		201,-		225,-				239,-	
tloušťka dveří	Kč	4790,-	34242	4810,-	062038	5400,-	34280			5720,-	34327
8 - 12 mm sklo	€	200,-		201,-		225,-				239,-	



		SNI		SNI - broušeno		Cr		Ms		TiN-C		TiN-K		TiN-B	
		cena / pár	EAN	cena / pár	EAN	cena / pár	EAN	cena / pár	EAN	cena / pár	EAN	cena / pár	EAN	cena / pár	EAN
tloušťka dveří	Kč	4310,-	027990	4330,-	34334	4330,-	34372	4330,-	062083	4940,-	34426	5260,-	34495	5260,-	34501
37 - 50 mm	€	180,-		181,-		181,-		181,-		206,-		220,-		220,-	
tloušťka dveří	Kč	4440,-	028003	4470,-	34341	4470,-	34389	4470,-	062090	5090,-	34440	5400,-	34518	5400,-	34525
51 - 68 mm	€	185,-		187,-		187,-		187,-		213,-		225,-		225,-	
tloušťka dveří	Kč	4600,-	028010	4630,-	34358	4630,-	34396	4630,-	062106	5260,-	34464	5570,-	34532	5570,-	34549
69 - 85 mm	€	192,-		193,-		193,-		193,-		220,-		233,-		233,-	
tloušťka dveří	Kč	4600,-	028027	4630,-	34365	4630,-	34402	4630,-	062113	5260,-	34488	5570,-	34556	5570,-	34563
8 - 12 mm sklo	€	192,-		193,-		193,-		193,-		220,-		233,-		233,-	
tloušťka dveří	Kč	4310,-	028034	4330,-	34570	4330,-	35003	4330,-	062168	4940,-	35089	5260,-	35126	5260,-	35164
37 - 50 mm	€	180,-		181,-		181,-		181,-		206,-		220,-		220,-	
tloušťka dveří	Kč	4440,-	028041	4470,-	34587	4470,-	35010	4470,-	062175	5090,-	35096	5400,-	35133	5400,-	35171
51 - 68 mm	€	185,-		187,-		187,-		187,-		213,-		225,-		225,-	
tloušťka dveří	Kč	4600,-	028058	4630,-	34594	4630,-	35027	4630,-	062182	5260,-	35102	5570,-	35140	5570,-	35188
69 - 85 mm	€	192,-		193,-		193,-		193,-		220,-		233,-		233,-	
tloušťka dveří	Kč	4600,-	028065	4630,-	34990	4630,-	35034	4630,-	062199	5260,-	35119	5570,-	35157	5570,-	35195
8 - 12 mm sklo	€	192,-		193,-		193,-		193,-		220,-		233,-		233,-	
tloušťka dveří	Kč	3970,-	028072	4000,-	69503	4000,-	69510	4000,-	062243	4630,-	69534	4940,-	69541	4940,-	69558
37 - 50 mm	€	166,-		167,-		167,-		167,-		193,-		206,-		206,-	
tloušťka dveří	Kč	4140,-	028089	4160,-	73975	4160,-	73999	4160,-	062250	4790,-	74033	5090,-	74057	5090,-	74071
51 - 68 mm	€	173,-		174,-		174,-		174,-		200,-		213,-		213,-	
tloušťka dveří	Kč	4310,-	028096	4330,-	73982	4330,-	74002	4330,-	062267	4940,-	74040	5260,-	74064	5260,-	74088
69 - 85 mm	€	180,-		181,-		181,-		181,-		206,-		220,-		220,-	
tloušťka dveří	Kč	4310,-	028102	4330,-	35201	4330,-	35218	4330,-	062274	4940,-	35232	5260,-	35249	5260,-	35256
8 - 12 mm sklo	€	180,-		181,-		181,-		181,-		206,-		220,-		220,-	
tloušťka dveří	Kč	4600,-	028119	4630,-	028157	4630,-	028195	4630,-	062328	5260,-	028270	5570,-	028317	5570,-	028355
38 - 50 mm	€	192,-		193,-		193,-		193,-		220,-		233,-		233,-	
tloušťka dveří	Kč	4760,-	028126	4790,-	028164	4790,-	028201	4790,-	062335	5400,-	028287	5720,-	028324	5720,-	028362
51 - 68 mm	€	199,-		200,-		200,-		200,-		225,-		239,-		239,-	
tloušťka dveří	Kč	4910,-	028133	4940,-	028171	4940,-	028218	4940,-	062342	5570,-	028294	5870,-	028331	5870,-	028379
69 - 85 mm	€	205,-		206,-		206,-		206,-		233,-		245,-		245,-	
tloušťka dveří	Kč	4910,-	028140	4940,-	028188	4940,-	028225	4940,-	062359	5570,-	028300	5870,-	028348	5870,-	028386
8 - 12 mm sklo	€	205,-		206,-		206,-		206,-		233,-		245,-		245,-	

Všechny varianty madel jsou pevné neotočné. Zakázkově lze připravit variantu s otočným madlem Entero.





SNi matný nikl



TiN-K titan černý mat

**Koule Maty**

2090,- Kč  
88,- EUR

Kč	materiál: masivní mosaz povrch: SNi matný nikl	EUR
2090,-		88,-
2260,-		95,-
2400,-		100,-
2400,-		100,-





Cr lesklý chrom



SNi matný nikl

**Koule Kemer**

1770,- Kč  
74,- EUR

Kč	materiál: masivní mosaz povrch: SNi matný nikl	EUR
1770,-		74,-
1940,-		81,-
2090,-		88,-
2090,-		88,-

Povrchy Ms-L, TiN-A, TiN-S – více na [www.kliky-mt.cz/katalog](http://www.kliky-mt.cz/katalog)





NRz nerez - broušeno



TiN-K titan černý mat

**Koule Maty**

1960,- Kč  
82,- EUR

Kč	materiál: nerezová ocel povrch: NRz nerez - broušeno	EUR
1960,-		82,-
2120,-		89,-
2270,-		95,-
2270,-		95,-



NRz nerez - broušeno

**Madlo Entero**

3770,- Kč  
158,- EUR

Kč	materiál: nerezová ocel povrch: NRz nerez - broušeno	EUR
3770,-		158,-
3920,-		164,-
4070,-		170,-
4070,-		170,-



		SNI		Cr		Ms		TiN-C		TiN-K	
		cena / pár	EAN	cena / pár	EAN	cena / pár	EAN	cena / pár	EAN	cena / pár	EAN
tloušťka dveří 37 - 50 mm	Kč €	2090,- 88,-	20283	2090,- 88,-	20290	2090,- 88,-	062403	2720,- 114,-	20689	3020,- 126,-	20696
tloušťka dveří 51 - 68 mm	Kč €	2260,- 95,-	73616	2260,- 95,-	73630	2260,- 95,-	062410	2870,- 120,-	73678	3190,- 133,-	73692
tloušťka dveří 69 - 85 mm	Kč €	2400,- 100,-	73623	2400,- 100,-	73647	2400,- 100,-	062427	3020,- 126,-	73685	3330,- 139,-	73708
tloušťka dveří 8 - 12 mm sklo	Kč €	2400,- 100,-	28586	2400,- 100,-	28593	2400,- 100,-	062434	3020,- 126,-	28616	3330,- 139,-	28623

Koule Maty na magnetických rozetách + 380 Kč příplatek.



		SNI		Cr		Ms		TiN-C		TiN-K	
		cena / pár	EAN	cena / pár	EAN	cena / pár	EAN	cena / pár	EAN	cena / pár	EAN
tloušťka dveří 37 - 50 mm	Kč €	1770,- 74,-	42698	1770,- 74,-	42704	1770,- 74,-	062489	2400,- 100,-	42728	2720,- 114,-	42735
tloušťka dveří 51 - 68 mm	Kč €	1940,- 81,-	73852	1940,- 81,-	73876	1940,- 81,-	062496	2560,- 107,-	73913	2870,- 120,-	73937
tloušťka dveří 69 - 85 mm	Kč €	2090,- 88,-	73869	2090,- 88,-	73883	2090,- 88,-	062502	2720,- 114,-	73920	3020,- 126,-	73944
tloušťka dveří 8 - 12 mm sklo	Kč €	2090,- 88,-	30237	2090,- 88,-	30244	2090,- 88,-	062519	2720,- 114,-	30978	3020,- 126,-	30985

		NRz		TiN-K		K-industrial	
		cena / pár	EAN	cena / pár	EAN	cena / pár	EAN
tloušťka dveří 37 - 50 mm	Kč €	1960,- 82,-	024982	2850,- 119,-	025026	2850,- 119,-	034486
tloušťka dveří 51 - 68 mm	Kč €	2120,- 89,-	024999	3000,- 125,-	025033	3000,- 125,-	034493
tloušťka dveří 69 - 85 mm	Kč €	2270,- 95,-	025002	3140,- 131,-	025040	3140,- 131,-	034509
tloušťka dveří 8 - 12 mm sklo	Kč €	2270,- 95,-	025019	3140,- 131,-	025057	3140,- 131,-	034516

Koule Maty na magnetických rozetách + 380 Kč příplatek.

		NRz		TiN-K		K-industrial	
		cena / pár	EAN	cena / pár	EAN	cena / pár	EAN
tloušťka dveří 37 - 50 mm	Kč €	3770,- 158,-	025064	4650,- 194,-	025101	4650,- 194,-	034523
tloušťka dveří 51 - 68 mm	Kč €	3920,- 164,-	025071	4800,- 200,-	025118	4800,- 200,-	034530
tloušťka dveří 69 - 85 mm	Kč €	4070,- 170,-	025088	4960,- 207,-	025125	4960,- 207,-	034547
tloušťka dveří 8 - 12 mm sklo	Kč €	4070,- 170,-	025095	4960,- 207,-	025132	4960,- 207,-	034554

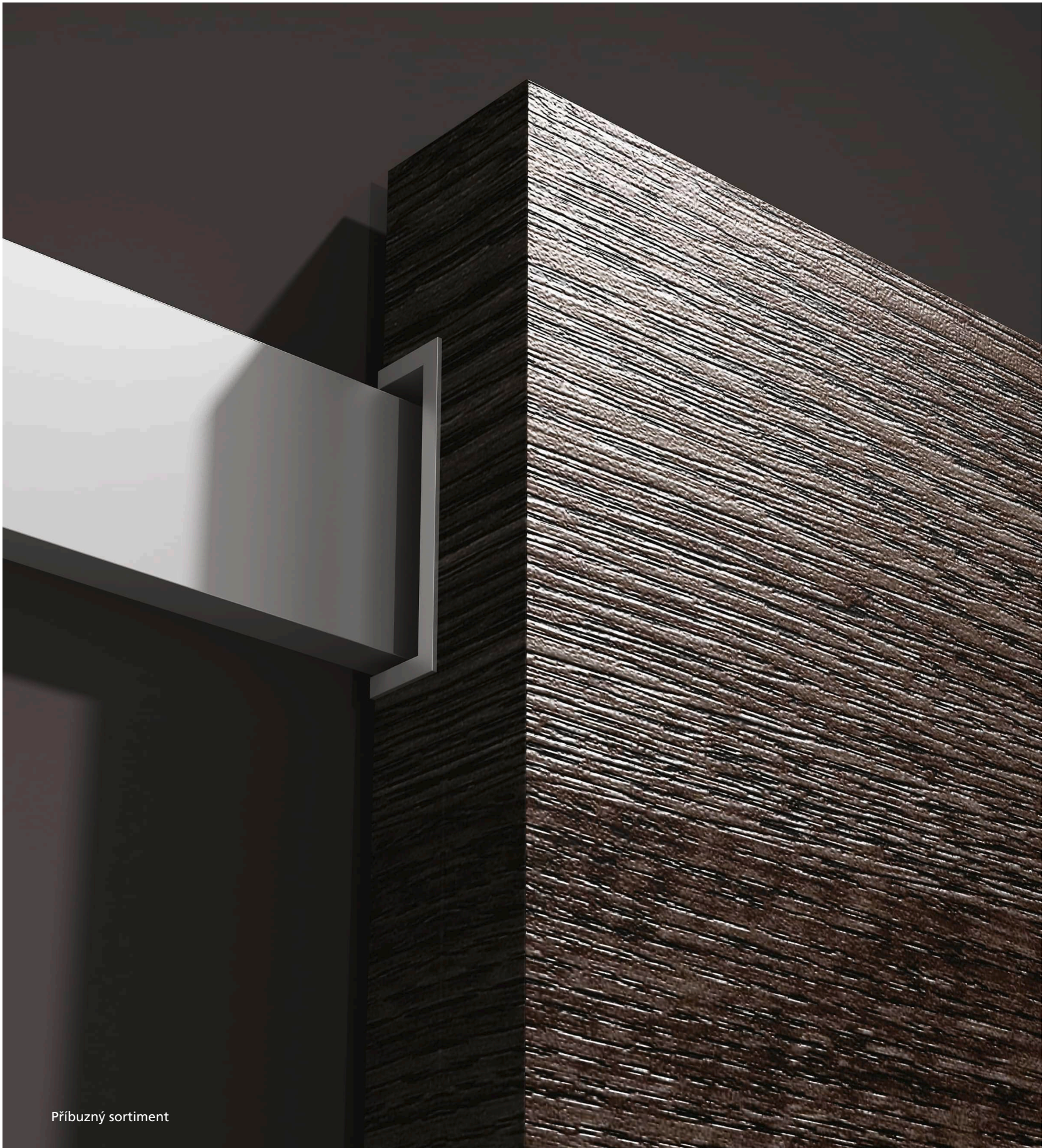

Příbuzný sortiment

Mušle Minimal / Maximal  
na skleněné posuvné dveře



Madla a koule na skleněné  
a dřevěné dveře



Mušle na posuvné dveře



Madla dlouhá



## Posuvný systém MINIMA 2.0 pro dřevěné a skleněné dveře

Materiál: hliník

Povrchy: stříbrný matný hliník, černý mat

Posuvný systém MINIMA 2.0 je inovativní svým řešením s perfektní funkčností a nepřehlédnutelným čistým designem, navazující na svého předchůdce posuv Minima. Posuv je konstruován s integrovaným zpomalovacím a tlumícím systémem při dojezdu v obou směrech. Vhodným doplňkem jsou ovládací mušle Minimal 2.0 vždy v barevném odstínu jako je posuv Minima. Perfektní volbou na skleněné dveře k posuvnému systému Minima je madlo Mimolimit, které v kombinaci masivní dřevo + sklo působí neopakovatelně. Výbornou volbou je také madlo Yes!

### MINIMA 2.0 na dřevěné dveře

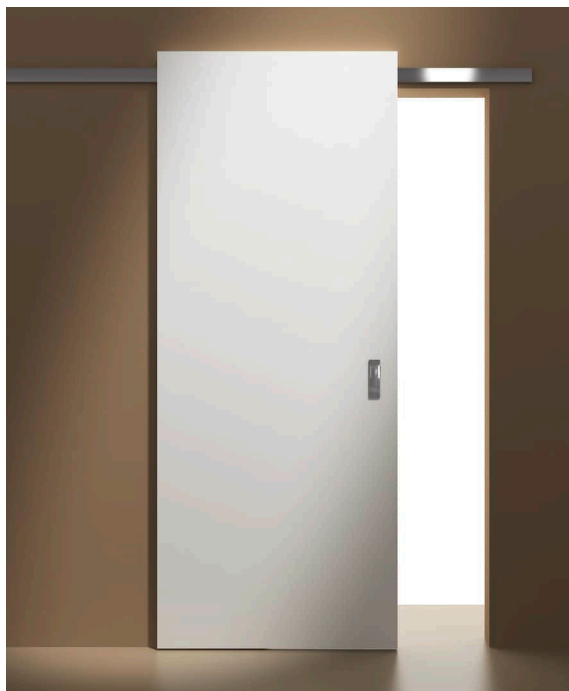

### MINIMA 2.0 na skleněné dveře

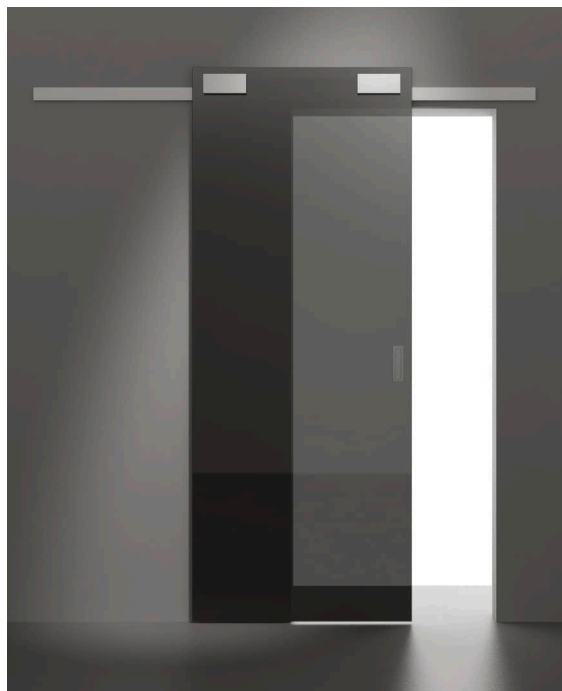

#### konstrukční varianty, materiálové provedení

- konstrukčně a montážně připraveno pro dveřní křídla do hmotnosti 80 kg
- univerzální systém pro dřevěné a skleněné dveře
- délky lišt 1700, 2000, 3000, 4000 a 6000 mm
- 2 varianty barevného provedení
- ovládací mušle a madla v identickém barevném provedení
- individuální rozměry délek lišt na základě požadavku
- záruka 3 roky

roky **3 garance**

Ochranné známky – registrované značky

MINIMA®



Patent

integrovaný zpomalovací a tlumící systém při dojezdu dveřního křídla v obou směrech

patent

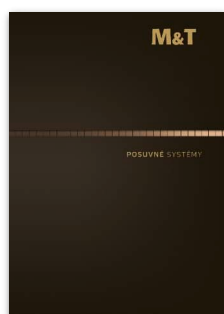

**Minima 2.0 pro dřevěné dveře**

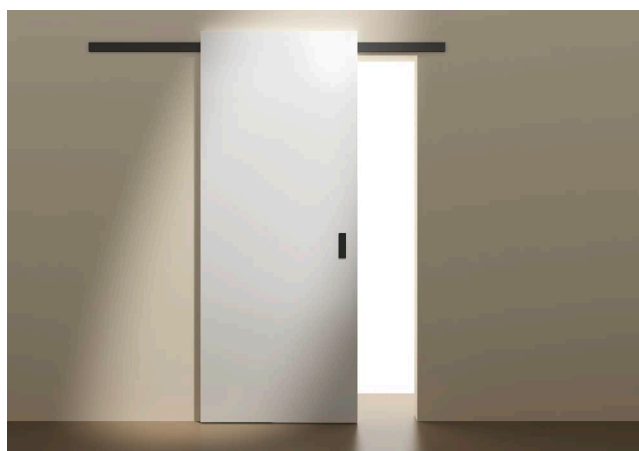

posuv **černý mat**  
mušle Minimal **TiN-K** titan černý mat

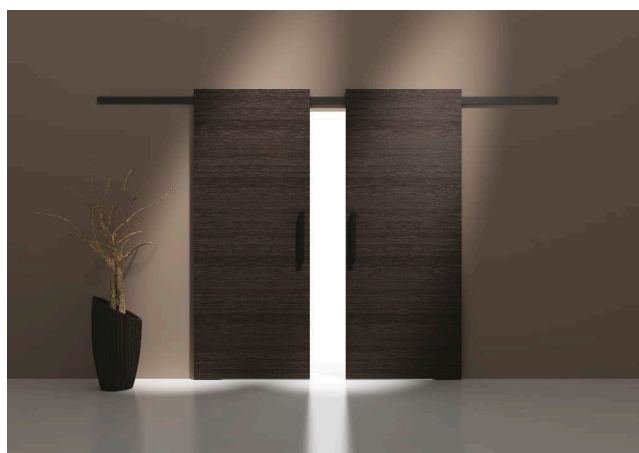

posuv **černý mat**  
madlo Minimal **TiN-K** titan černý mat



posuv **stříbrný matný hliník**  
mušle Minimal **SNi** matný nikel

**Pojezdová nosná lišta**

2410,- Kč  
101,- EUR

**Krycí lišta**

2080,- Kč  
87,- EUR

**Minima sada s tlumiči**

5300,- Kč  
221,- EUR

**Spodní vodící lišta**

340,- Kč  
15,- EUR

**KČ** materiál: hliník povrch: stříbrný matný hliník **EUR**

2410,- 101,-

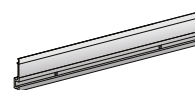

2670,- 112,-

3790,- 158,-

4710,- 197,-

6580,- 275,-

2080,- 87,-

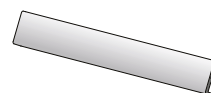

2360,- 99,-

3690,- 154,-

4750,- 198,-

6890,- 288,-

**KČ** **EUR**

5300,- 221,-

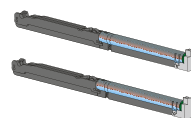

**KČ** povrch: stříbrný TPE polymer **EUR**

340,- 15,-





	Stříbr. matný hliník			Černý mat	
		cena / ks	EAN	cena / ks	EAN
1700 mm	Kč €	2410,- 101,-	153217	2920,- 122,-	153262
2000 mm	Kč €	2670,- 112,-	153224	3170,- 133,-	153279
3000 mm	Kč €	3790,- 158,-	153231	4290,- 179,-	153286
4000 mm	Kč €	4710,- 197,-	153248	5200,- 217,-	153293
6000 mm	Kč €	6580,- 275,-	153255	7560,- 315,-	153309
1700 mm	Kč €	2080,- 87,-	153316	2920,- 122,-	153361
2000 mm	Kč €	2360,- 99,-	153323	3200,- 134,-	153378
3000 mm	Kč €	3690,- 154,-	153330	4520,- 189,-	153385
4000 mm	Kč €	4750,- 198,-	153347	5580,- 233,-	153392
6000 mm	Kč €	6890,- 288,-	153354	8550,- 357,-	153408

		cena / ks	EAN
80 kg pro dřevěné dveře	Kč €	5300,- 221,-	153422

	Stříbrný TPE polymer		
		cena / ks	EAN
1000 mm	Kč €	340,- 15,-	153439

Posuvný systém pro dveře se skládá z pojezdové nosné lišty + krycí lišty + sady s tlumiči a příslušenstvím. Z těchto tří komponentů se sestavuje kompletní posuv Minima. Pojezdová nosná lišta a krycí lišta jsou univerzální pro oba systémy, sada s tlumiči je odlišná pro dřevěné a skleněné dveře.

**Pozor! Posuvný systém Minima je nahrazen novou verzí Minima 2.0. Zároveň postupně dochází k doprodeji dosavadního posuvu Minima. O dostupnosti posuvu Minima se informujte vždy před objednáním.**

**Minima 2.0 glass**



posuv **černý mat**  
madlo Mimolimit **TiN-K** titan černý mat + teak

**Pojezdová nosná lišta**

2410,- Kč  
101,- EUR

**KČ** materiál: hliník povrch: stříbrný matný hliník **EUR**

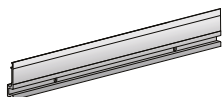
2410,-		101,-
2670,-		112,-
3790,-		158,-
4710,-		197,-
6580,-		275,-

**Krycí lišta**

2080,- Kč  
87,- EUR

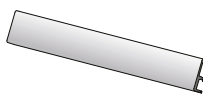
2080,-		87,-
2360,-		99,-
3690,-		154,-
4750,-		198,-
6890,-		288,-

**KČ** povrch: stříbrný matný hliník **EUR**

**Minima glass sada s tlumiči**

7280,- Kč  
304,- EUR

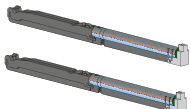
7280,-		304,-
--------	---	-------



posuv **stříbrný matný hliník**  
mušle Minimal **SNi** matný nikel

		Stříbr. matný hliník		Černý mat	
		cena / ks	EAN	cena / ks	EAN
1700 mm	Kč €	2410,- 101,-	153217	2920,- 122,-	153262
2000 mm	Kč €	2670,- 112,-	153224	3170,- 133,-	153279
3000 mm	Kč €	3790,- 158,-	153231	4290,- 179,-	153286
4000 mm	Kč €	4710,- 197,-	153248	5200,- 217,-	153293
6000 mm	Kč €	6580,- 275,-	153255	7560,- 315,-	153309

1700 mm	Kč €	2080,- 87,-	153316	2920,- 122,-	153361
2000 mm	Kč €	2360,- 99,-	153323	3200,- 134,-	153378
3000 mm	Kč €	3690,- 154,-	153330	4520,- 189,-	153385
4000 mm	Kč €	4750,- 198,-	153347	5580,- 233,-	153392
6000 mm	Kč €	6890,- 288,-	153354	8550,- 357,-	153408

		Stříbr. matný hliník		Černý mat	
		cena / ks	EAN	cena / ks	EAN
80 kg pro skleněné dveře	Kč €	7280,- 304,-	153453	7790,- 325,-	153446

Posuvný systém pro dveře se skládá z pojezdové nosné lišty + krycí lišty + sady s tlumiči a příslušenstvím. Z těchto tří komponentů se sestavuje kompletní posuv Minima. Součástí sady je i stavitelný vodící blok. K posuvnému systému doporučujeme mušle Minimal / Maximal v identické barvě povrchu jako je posuv.



posuv **Minima Glass** povrch černá mat

**Pozor! Posuvný systém Minima je nahrazen novou verzí Minima 2.0. Zároveň postupně dochází k doprodeji dosavadního posuvu Minima. O dostupnosti posuvu Minima se informujte vždy před objednávkou.**

**Systém pro dřevěné dveře**  
**Minima 2.0**

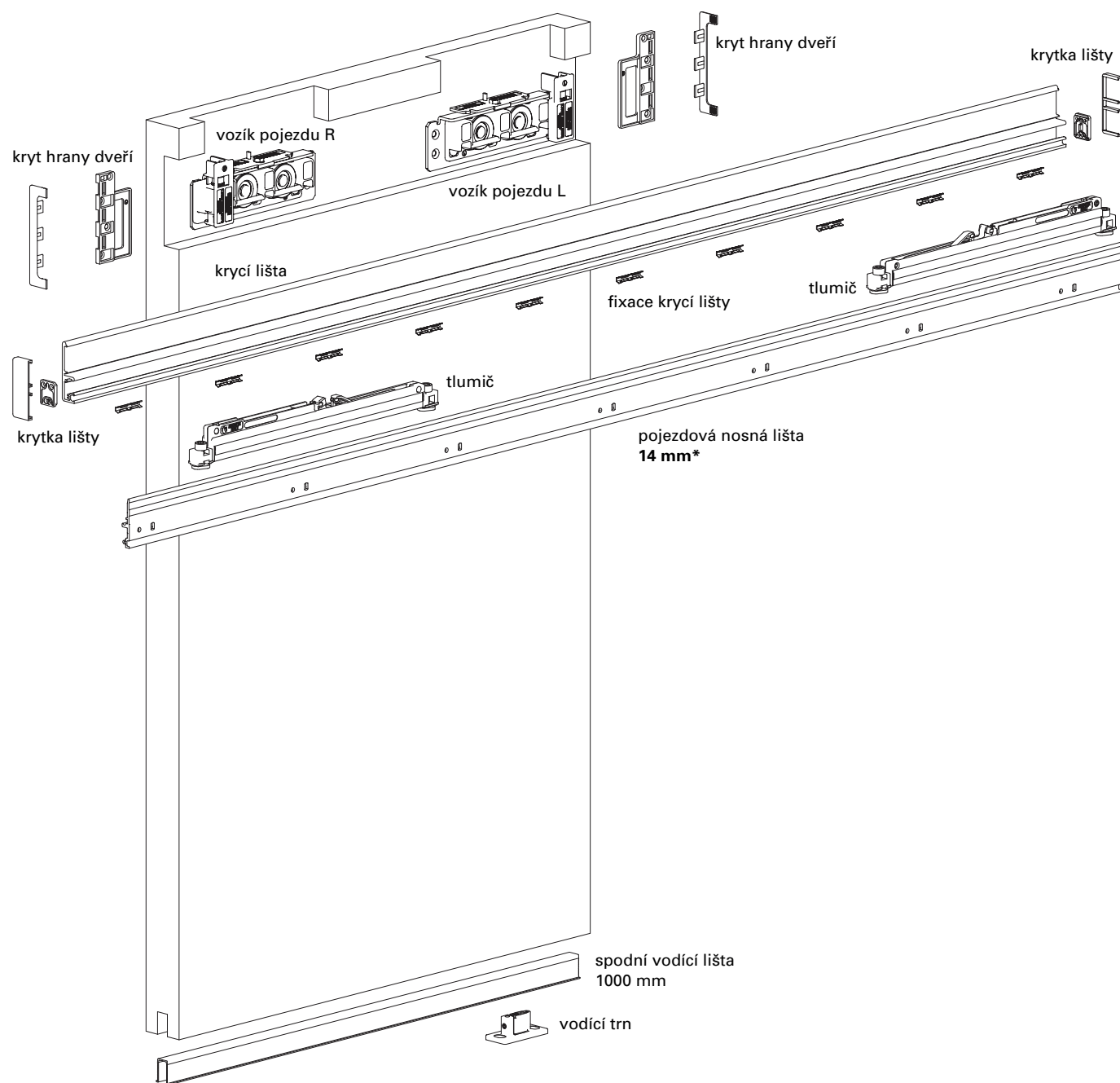

**\* rozměr 14 mm**

- je odsazení desky dveřního křídla od stěny po montáži na pojezdovou nosnou lištu

**tlumič**

- pro dveře max. 80 kg

**vše ve stejném povrchu**

- krycí lišta
- pojezdová nosná lišta
- kryt hrany dveří
- krytka lišty

**povrchy - barvy**

- stříbrný matný hliník
- černý mat

**délky lišt**

- 1700 mm
- 2000 mm
- 3000 mm
- 4000 mm
- 6000 mm

individuálně možnost jiného rozměru

**System pro skleněné dveře**  
**Minima 2.0 glass**

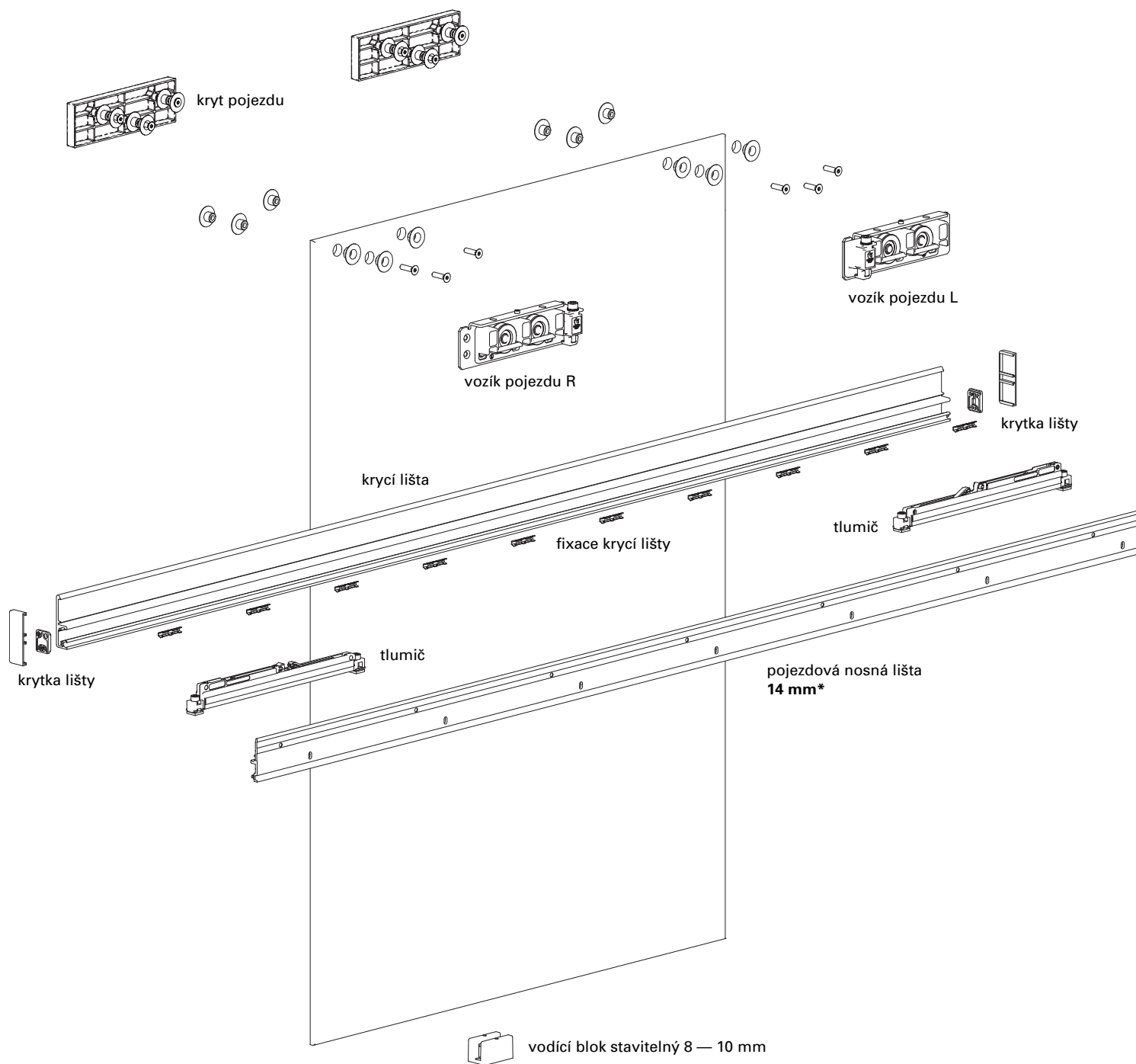

**vše ve stejném povrchu**

- kryt pojezdu
- krytka lišty
- krycí lišta
- pojezdová nosná lišta
- vodící blok

**délky lišt**

- 1700 mm
- 2000 mm
- 3000 mm
- 4000 mm

individuálně možnost jiného rozměru

**tlumič**

- pro dveře max. 80 kg

**povrchy - barvy**

- stříbrný matný hliník
- černý mat



Příbuzný sortiment

Zapuštěné soklové lišty



Systém Magnetic



Ovládací madla Magnetic



Magnetické zámky



Dveřní kliky



## Neviditelné zárubně

Vyvinuli jsme kompletní dveřní systém pro minimalistické interiéry – neviditelné zárubně MINIMA. Zásadní předností je komplexnost řešení. Rozměrově lze zárubně využít bez jakýchkoliv omezení do výšky 4000 mm. Pro technické prostory a objekty se zvýšenými požadavky jsou zárubně připraveny s certifikací požární odolnosti, akustickou a bezpečnostní odolností, s návazností na obklady okolních stěn a systémové zapuštěné podlahové lišty. Připraveno pro systém Magnetic.

Testováno ve vlastní robotické zkušebně na 40 let provozu.

Tento produkt je určen pouze pro partnery - smluvní výrobce dveří a není samostatně v prodeji. Každá zárubeň je vyráběna zakázkově v požadovaném rozměru, objednávaná přes klientské rozhraní, expedována s identifikací zadanou partnerem tj. místem určení, rozměrem, pozicí na stavbě, označením místnosti popř. dalšími požadovanými informacemi. Dodávána včetně všech důležitých montážních komponentů (perlinka, pružná stěrková hmota, lepidlo, hmoždinky, vruty), s kvalitním teflonovým těsněním.

**Materiál: hliník**

**Povrchy: černý mat, přírodní povrch bez eloxu**

### Minima 40

pro dveře tl. 40 mm varianty Classic a Revers



### Minima 60

pro dveře tl. 60 mm Classic a Revers



Pro dokonale hladký celek doporučujeme neviditelné zárubně doplnit systémem Soclick pro zapuštěné soklové lišty. Oba systémy se osazují do stavby současně.

V případě kombinace zárubní a skrytých soklových lišt **POZOR**, u zárubní C40 a R40 je v rámci objednávky nutno specifikovat úpravu pro napojení soklových lišt. Detaily napojení viz strana 359.

#### hlavní výhody

- součástí zárubně je:
    - nacvakávací lišta s armovací tkaninou pro napojení na ostatní stavební materiály (sádrokarton, zdivo)
    - pružná stěrková hmota Hard & Elastic s jedinečnými vlastnostmi zabraňujícími popraskání zdiva kolem zárubně (testováno se všemi druhy běžného zdiva)
    - teflonové těsnění s výběrem 7 odstínů
  - konstrukce s dutým U profilem pro vložení materiálu povrchové a barevně shodného s dveřmi
  - Neviditelné zárubně Minima jsou prakticky neviditelné i při otevřených dveřích
  - návaznost na systémovou zapuštěnou soklovou lištu Soclick
  - u zárubně se nerozlišuje levé a pravé provedení
  - i po osazení zárubně lze měnit orientaci dveří L x P
  - připraveno pro systém Magnetic
  - zárubně vyráběny ve dvou provedeních tj. černá matná a přírodní hliník pro možnost nátěru
- další speciální výhody zárubně Minima 60:
    - požární odolnost 60 min do rozměru dveří 1050x2750, při tl. dveří 60 mm
    - akustická odolnost
    - bezpečnostní odolnost
    - návaznost na okolní obložení zdiva až do tl. 12 mm (např. obklady koupelen)

Patent

konstrukce zárubně Minima

patent

## Konstrukce

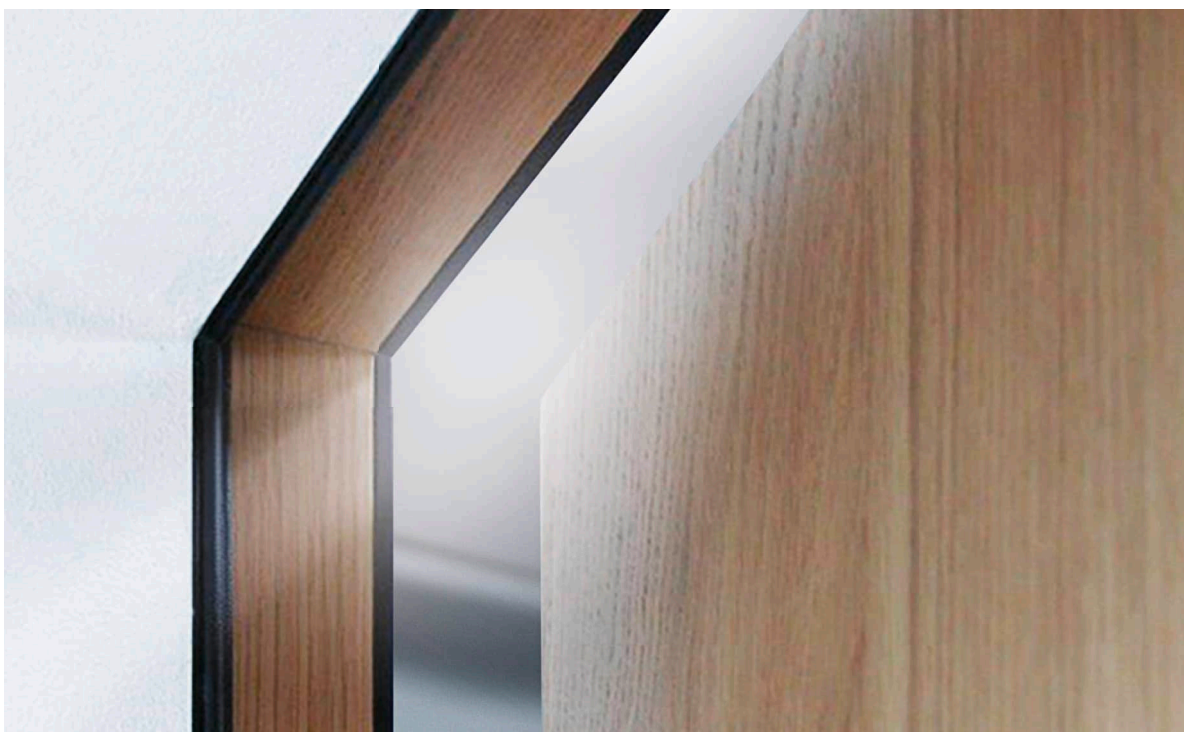

Patentovaná konstrukce zárubně, kdy se do hliníkové komory vkládá dřevěná vložka vyrobená podle požadavků na celkový design, tzn. s možností materiálové a barevné volby pro efekt neviditelné zárubně i při otevřených dveřích.

## Design

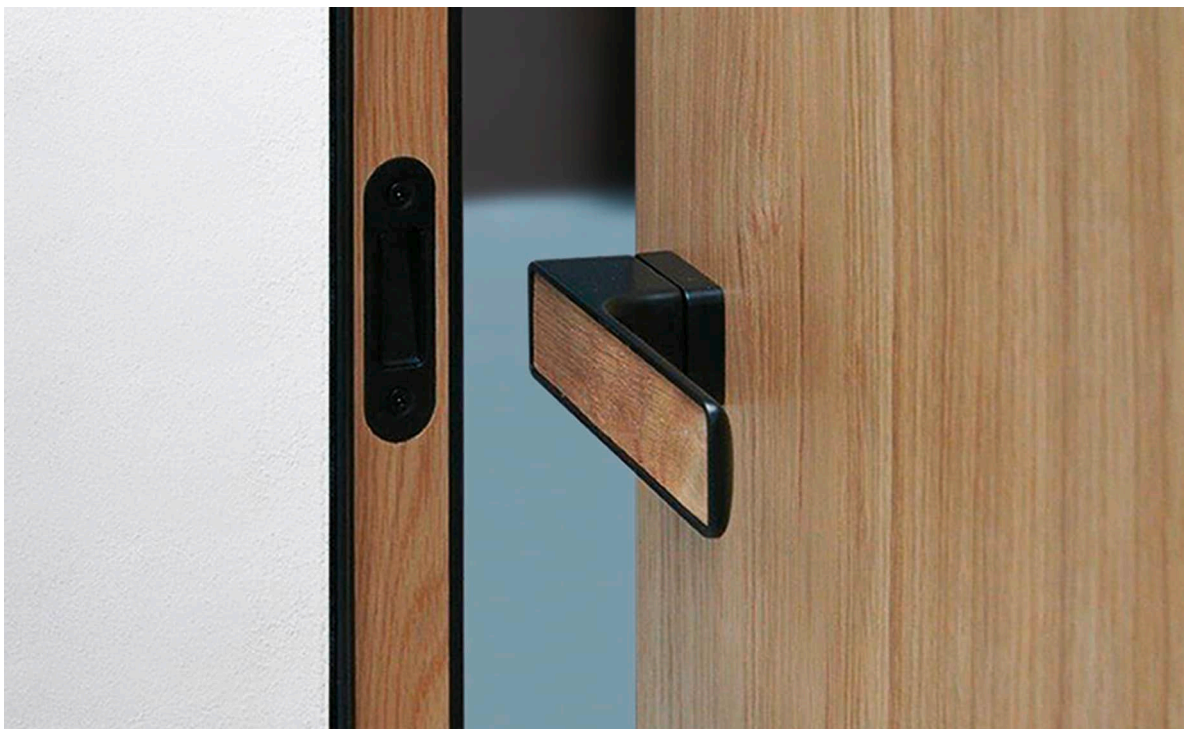

Společně s dveřním kováním Maximal Ize dosáhnout úplného sladění s dveřmi a zárubní



## Systemové řešení



Konstrukce je vybavena systémovou nacvakávací lištou s armovací tkaninou a stěrkovou elastickou hmotou Hard & Elastic zabráňující popraskání zdiva kolem zárubně.

## Technické přednosti

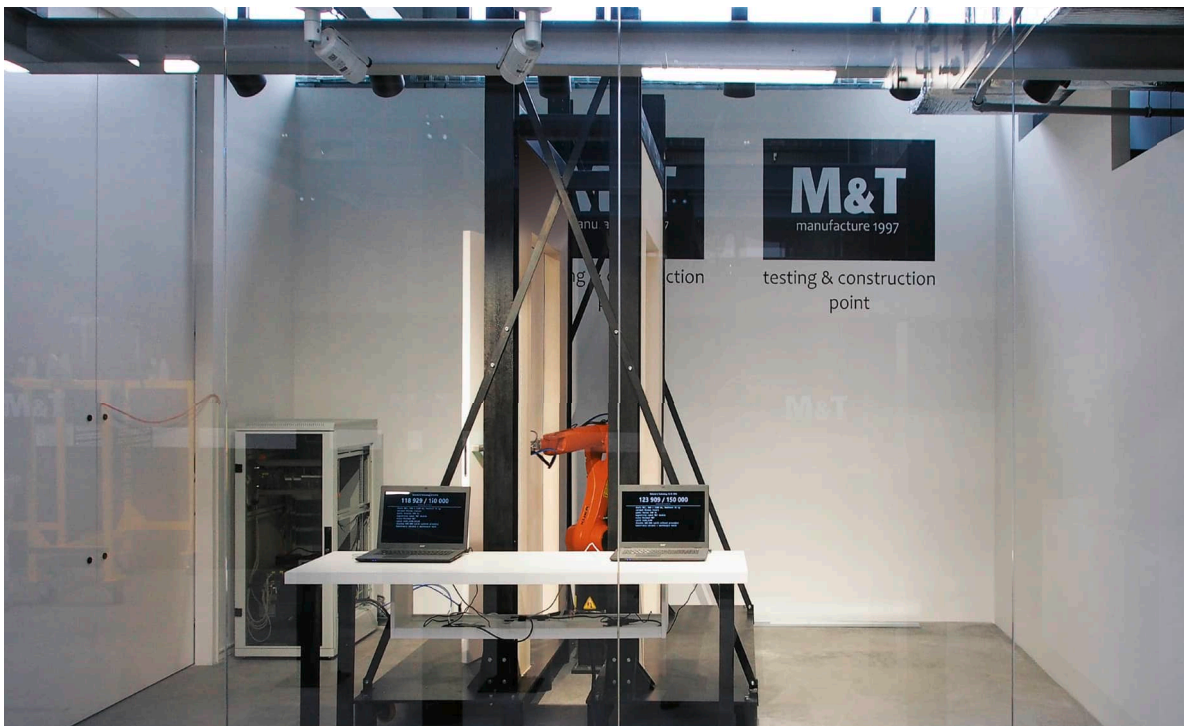

Zásadní je perfektní funkčnost celého systému. Proto jsme 8 měsíců testovali veškeré komponenty v různých podmínkách, se zárubní zabudovanou v různých typech zdiva, celkem přes 600.000 cyklů.

## K zárubním připraveny komponenty

3D panty stříbrné, černé, bílé Simonswerk Tectus 240, 340

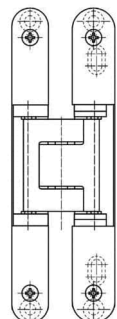

pant Tectus 240

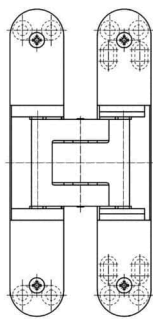

pant Tectus 340

Magnetické zámky s protiplechy stříbrné, černé, bílé

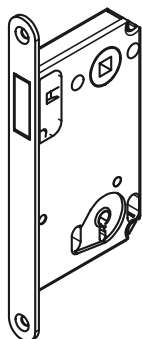

magnetický zámek  
dozický

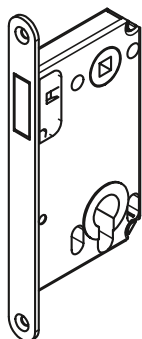

magnetický zámek  
cylindrický

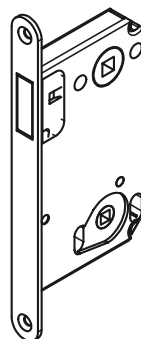

magnetický zámek  
WC

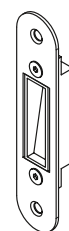

seřiditelný protiplech

Nápínák/ vyrovnavač dveří M&T .. stavebnicová konstrukce pro délky 1970 – 3000 mm

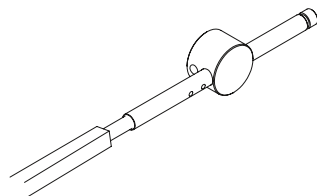

Padací lišty se zpožděním, protipožární lišty

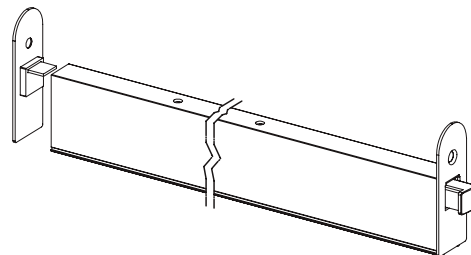

Protipožární teplotní zajišťovač dveří Firebold

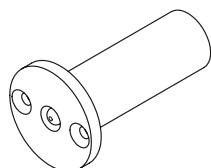





Příbuzný sortiment

Neviditelné zárubně



Magnetic



Ovládací madla



Magnetický zámek



Dveřní kování



## Soklový systém MINIMA Soclick pro zapuštěné soklové lišty

MINIMA Soclick přináší ucelený systém s bezkonkurenční kapacitou vkládaného materiálu a flexibilitou kombinačních řešení. Skrytý sokl je navržen tak, aby pojmul materiály o tloušťce až 11,5 mm a také aby umožnil použití LED osvětlení včetně difuzoru. Tento produkt doplňuje rodinnou řadu systémů M&T pro interierová řešení, zejména pak Neviditelné Zárubně.

Materiál: hliník

Povrchy: surový hliník



Soclick 65 pro materiály do tloušťky až 11,5 mm včetně lepidla

- nosný profil umožňuje vkládání materiálu o rozměrech až 11,5 mm s libovolnou výškou
- systémově lze kombinovat s profilem pro LED pásky a to včetně difuzoru
- použitím dalších stavebnicových prvků je možné dosáhnout pestrých materiálových, ale i funkčních kombinací



Soclick LED pro kombinaci s LED osvětlením s difuzorem

- systém umožňující použití plnohodnotného LED osvětlení
- šířka pásků do 10 mm
- v kombinaci profilu Click s Nosným profilem 65 mm vzniká komora 5x25 mm pro přívod napájecích kabelů

### hlavní výhody

- celý projekt jeden design, s naším systémovým řešením dokonale sladíte celý interiér (osoklujete vše, co vám stojí v cestě)
- při použití celé stavebnice máte jistotu snadného přístupu k elektronickým součástkám a rozvodům. Profil Click „prostě vycvaknete“ a dostanete se kam je potřeba
- Soclick je součástí systému neviditelných zárubní. Podrobnosti se dozvíte v montážním návodu.

Patent

patent

konstrukce soklové lišty + přídatných komponentů

## Soklový systém MINIMA Soclick - varianty

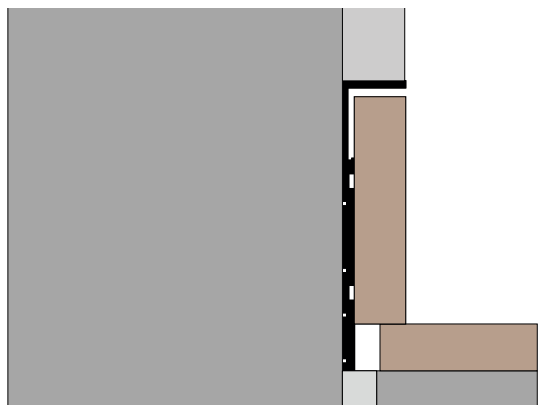

### Nosný profil 65 mm

Základní profil s libovolnou výplní o tloušťce až 11,5 mm. Decentní řešení pro sjednocení vašeho interiéru.

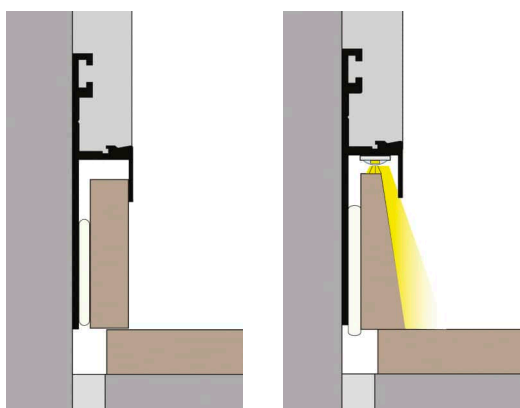

### Soclick Projekt

Inovovaná soklová lišta s absencí detailu viditelné stínové spáry o venkovních rozměrech 14,2 × 65 mm, s komorou pro vkládaný materiál do tloušťky ~ 11,5 mm dokáže pojmout většinu běžných podlahovin, včetně keramických obkladů. Tento detail kromě vkládání klasických soklových lišt umožňuje nepřímé osvětlení LED pásky. Šířka LED pásky pro nepřímé osvětlení je max. 10 mm.

V případě realizování varianty LED je nutné objednat speciální montážní sadu, díky níž je možné demontovat a navrátit výplň soklu za účelem přístupu k LED páskům až 20x. Komponent pro rozebíratelný spoj má celkovou tloušťku 2,5 mm.

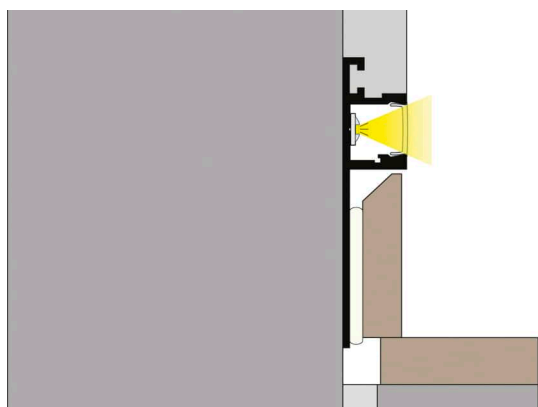

### Soclick LED

Inovovaná soklová lišta s komorou pro LED pásky kompatibilní s kvalitními nacvakávacími difuzory. Výplň soklového profilu do tloušťky ~ 11,5 mm.

Konstrukce nabízí přímé, nebo nepřímé osvětlení viz umístění LED pásky v grafice níže. Šířka LED pásky pro přímé osvětlení je max. 10 mm a pro nepřímé max. 8 mm.

Dodáváno v setu včetně montážního a pohledového difuzoru. Surový hliníkový profil určený ke kompletnímu přemalování, v barevné kombinaci s mléčným difuzorem, nebo s černým difuzorem.

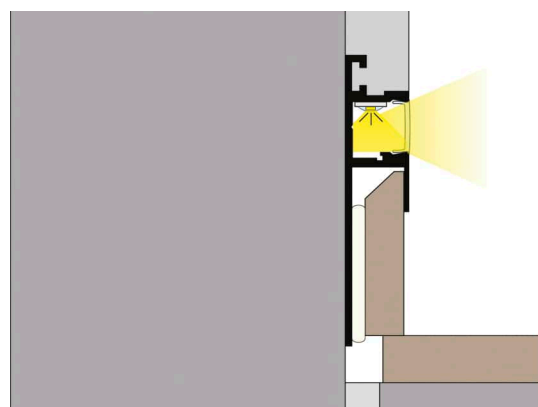

### Soclick LED Projekt

Stejně vlastnosti jako Soclick LED s absencí stínové spáry. Tímto eliminuje viditelnost odchylek podlahářských norem. Řešení vhodné pro realizace velkých rozsahů, s komorou pro vkládaný materiál do tloušťky ~ 11,5 mm. Demontovatelné verze výplně soklu do tloušťky ~ 8 mm.

Dodáváno v setu včetně montážního a pohledového difuzoru. Surový hliníkový profil určený ke kompletnímu přemalování, v barevné kombinaci s mléčným difuzorem, nebo s černým difuzorem. V případě zájmu je možné objednat speciální montážní sadu, která umožňuje demontovat a opět navrátit výplň soklu až 20x. Komponent pro rozebíratelný spoj má celkovou tloušťku 2,5 mm.

Tloušťku a profilování výplně doporučujeme předem otestovat pro určení skladby podlahy a výšky pohledové části soklu.

## Výhody neviditelného Soclicku

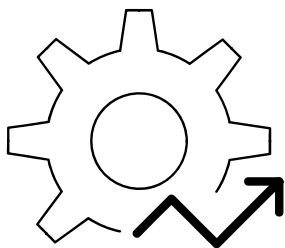

### Funkční design

Použitím patentovaných skrytých soklů Soclick dostanete ze svého interiéru maximum. Ať už jde o optické zvětšení místnosti, nebo třeba možnost umístění nábytku až ke stěně.

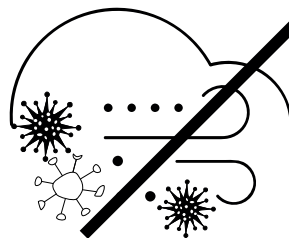

### Hygiena

Se Soclickem prach, bakterie ani nečistoty nemají kde ulpívat. Naše řešení je plně uzavřené a to i v případě použití LED pásků, které jsou umístěné pod difuzorem.



### Bezpečnost

Soclick pro schodiště v kombinaci s LED profilem může poskytnout příjemné ambientní osvětlení schodišť a přispět tak ke zvýšení bezpečnosti jejich užívání.

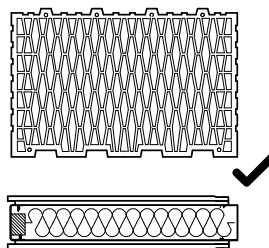

### Pro všechny typy staveb

Naše skryté sokly jsou konstruovány pro výstavbu suchou i mokrou metodou. Předvrtané otvory pro montáž jsou v rozměrech dle rastru pro sádkartonové konstrukce.

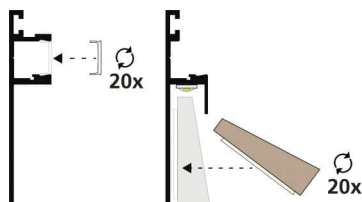

### Soclick Projekt

Naše řešení umožňuje opakovatelný přístup k elektronickým součástkám, které mají omezenou životnost. Bez rizik poškození omítky, či podlahy tak můžete vyměnit vysloužilé LED pásky, nebo např. napájecí zdroje.

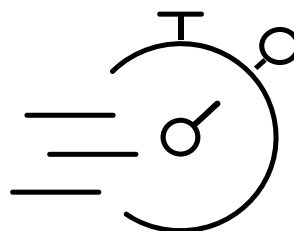

### Snadná montáž

Součástí systému je standardně dodávána sada příslušenství a obrázkový montážní návod s postupem krok za krokem, pro správnou a rychlou montáž.

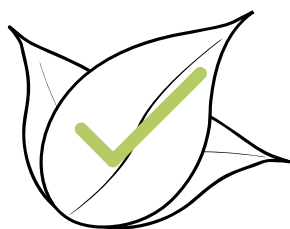

### Myslíme zeleně

Tak jako i u ostatních profilů v portfoliu M&T klademe důraz na udržitelnost produkce. Proto spolupracujeme pouze s nejbližšími výrobci z okolních států, navíc certifikovanými ISO 14001 a ISO 50001.

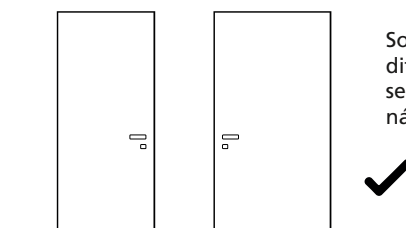

### Kompatibilní s M&T Neviditelnými Zárubněmi

Soclick je součástí systému neviditelných zárubní. Podrobnosti se dozvíte v montážním návodu.

Soklový systém MINIMA Soclick pro zapuštěné soklové lišty

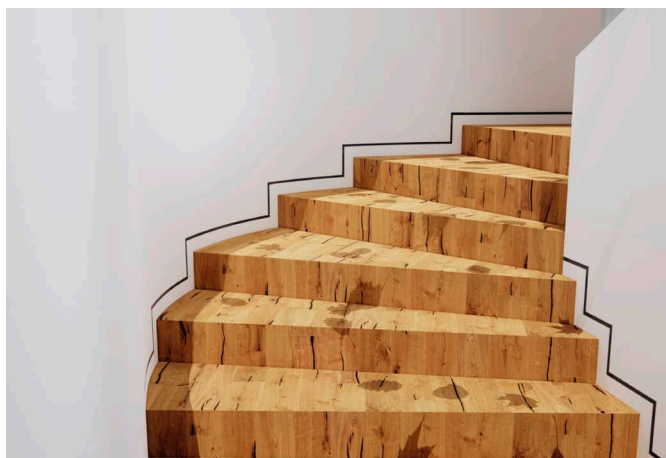

**Nosný profil 65 mm**

560,- Kč  
24,- EUR

**Soclick Projekt**

660,- Kč  
29,- EUR

materiál: hliník  
Kč povrch: přírodní povrch bez eloxu EUR

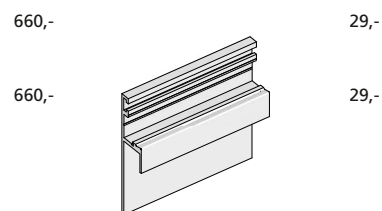
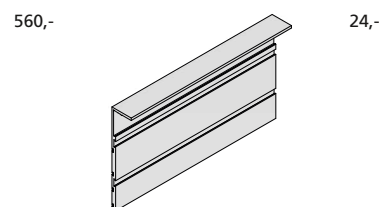

**Click profil 44 mm**

430,- Kč  
18,- EUR

materiál: hliník  
Kč povrch: přírodní povrch bez eloxu EUR

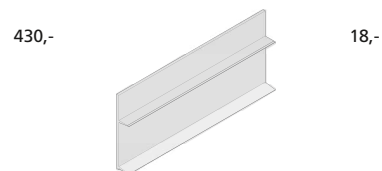

**Click profil 30 mm**

430,- Kč  
18,- EUR

materiál: hliník  
Kč povrch: přírodní povrch bez eloxu EUR

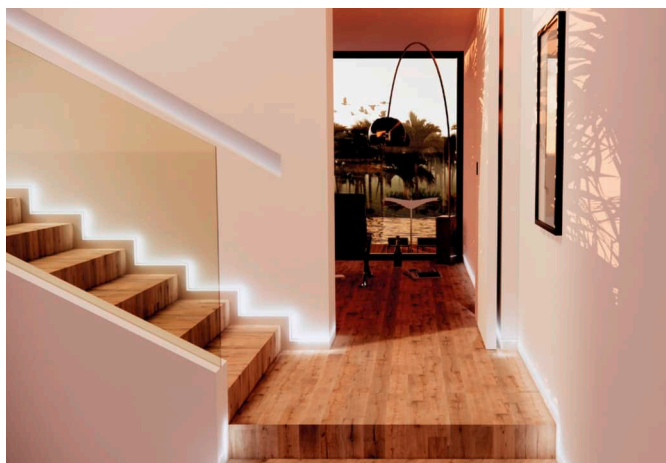

**Soclick LED**

Cena zahrnuje: surový hliníkový profil, montážní difuzor a mléčný nebo černý difuzor

990,- Kč  
42,- EUR

materiál: hliník  
Kč EUR

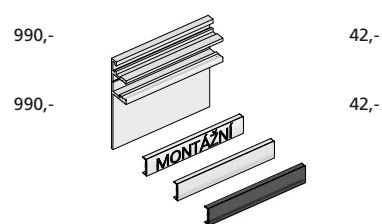

**Soclick LED Projekt**

Cena zahrnuje: surový hliníkový profil, montážní difuzor a mléčný, nebo černý difuzor

1090,- Kč  
46,- EUR

materiál: hliník  
Kč EUR

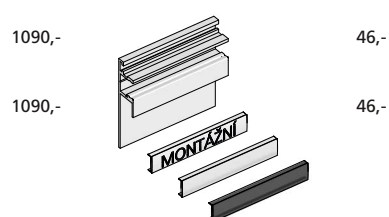



		Hliník	
		cena / m	EAN
délka 1950 mm	Kč €	560,- 24,-	130812

Základní profil celého systému, do kterého lze volitelně nacvaknout další funkční prvky. Profil je dodáván předvrtaný v rastru SDK konstrukcí a je opatřený ochrannou fólií proti zanesení omítkou.

Dostupný v délkách: 2500 mm (EAN 144253), 3020 mm (EAN 135848), 3520 mm (EAN 135855), 4020 mm (EAN 135862), 4520 mm (EAN 135879).



		Hliník	
		cena / m	EAN
délka 3000 mm	Kč €	660,- 29,-	156119
délka 4000 mm	Kč €	660,- 29,-	156126

Soclick projekt je inovovaná soklová lišta o venkovních rozměrech 14,2x65 mm, s komorou pro vkládaný materiál do tloušťky ~ 11,5 mm. Veškeré další komponenty (napojení na neviditelné zárubně, flexi provedení, schodové dílce naleznete v klientské zóně [kz.neviditelne-zarubne.cz](http://kz.neviditelne-zarubne.cz)). Tento profil není kompatibilní s profily Click.

		Hliník	
		cena / m	EAN
délka 1950 mm	Kč €	430,- 18,-	130829

Pro kombinaci s LED profilem nebo jako nosič pro vkládaný materiál o tloušťce až 4 mm a pro výšku nad 50 mm. Použitím tohoto prvku vzniká komora 5x25 mm pro přívod napájecích kabelů k LED páskům. Ideální pro materiály typu - marmoleum, vinyl a koberce.

		Hliník	
		cena / m	EAN
délka 1950 mm	Kč €	430,- 18,-	130836

Pro kombinaci s LED profilem nebo jako nosič pro vkládaný materiál o tloušťce až 4 mm a pro výšku nad 50 mm. Použitím tohoto prvku vzniká komora 5x25 mm pro přívod napájecích kabelů k LED páskům. Ideální pro materiály typu - marmoleum, vinyl a koberce.

		Hliníkový profil, montážní a mléčný difuzor		Hliníkový profil, montážní a černý difuzor	
		cena / m	EAN	cena / m	EAN
délka 3000 mm	Kč €	990,- 42,-	156133	1090,- 46,-	156157
délka 4000 mm	Kč €	990,- 42,-	156140	1090,- 46,-	156164

Soclick LED je inovovaná soklová lišta s komorou pro LED pásky kompatibilní s kvalitními nacvakávacími difuzory, v barvách matná mléčná nebo černá.

Veškeré další komponenty (napojení na neviditelné zárubně, flexi provedení, schodové dílce naleznete v klientské zóně [kz.neviditelne-zarubne.cz](http://kz.neviditelne-zarubne.cz)). Tento profil není kompatibilní s profily Click.

		Hliníkový profil, montážní a mléčný difuzor		Hliníkový profil, montážní a černý difuzor	
		cena / m	EAN	cena / m	EAN
délka 3000 mm	Kč €	1090,- 46,-	156171	1190,- 50,-	156195
délka 4000 mm	Kč €	1090,- 46,-	156188	1190,- 50,-	156201

Stejně vlastnosti jako Soclick LED s absencí stínové spáry. Tímto eliminuje viditelnost odchylek podlahářských norem. Profil je kompatibilní s kvalitními nacvakávacími difuzory, v barvách matná mléčná nebo černá.

Veškeré další komponenty (napojení na neviditelné zárubně, flexi provedení, schodové dílce naleznete v klientské zóně [kz.neviditelne-zarubne.cz](http://kz.neviditelne-zarubne.cz)). Tento profil není kompatibilní s profily Click.

Tolerance délky profilu +10/ -10 mm. O možnosti dodání jiných, než uvedených délek se informujte u svého prodejce. Přepravní náklady budou kalkulovány individuálně podle objemu zakázky a PSČ.

## Soklový systém MINIMA Soclick pro zapuštěné soklové lišty

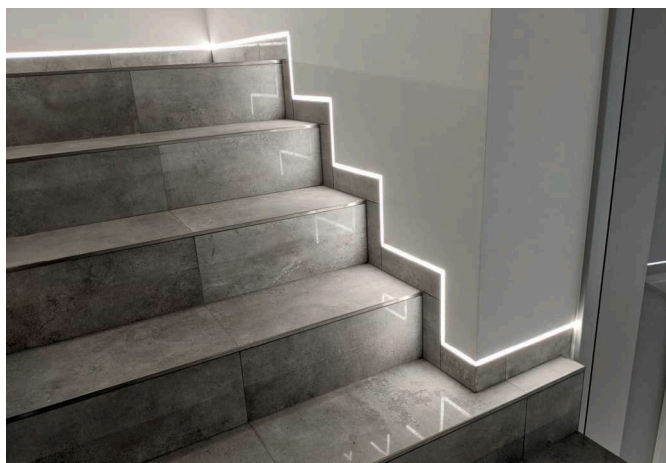

### Nosný profil 65 mm schodový

960,- Kč  
40,- EUR

materiál: hliník  
Kč povrch: surový, eloxovaný hliník EUR

960,- 40,-

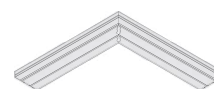

1960,- 82,-



nosný profil 65 mm schodový levý + LED

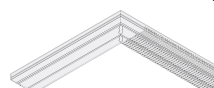

nosný profil 65 mm schodový flexi levý

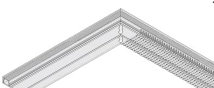

nosný profil 65 mm schodový flexi levý + LED



### Nosný profil 65 mm FLEXI Soclick LED FLEXI

3530,- Kč  
148,- EUR

materiál: hliník  
Kč povrch: surový, eloxovaný hliník EUR

3530,- 148,-

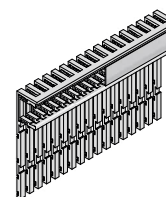

4120,- 172,-

4170,- 174,-

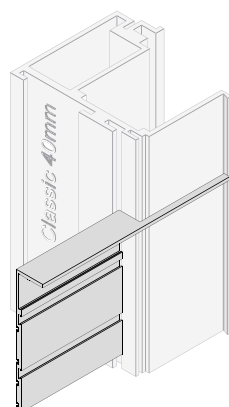
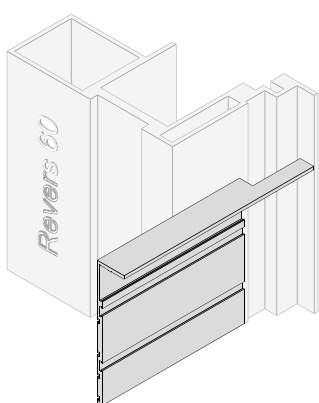

### Nosný profil 65 mm napojení na zárubeň

780,- Kč  
33,- EUR

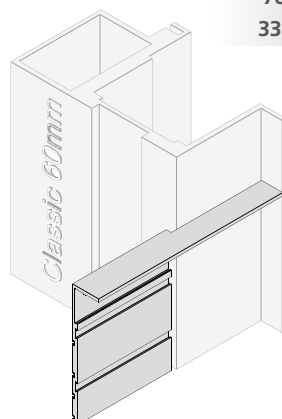

materiál: hliník  
Kč povrch: přírodní povrch bez eloxu EUR

780,- 33,-

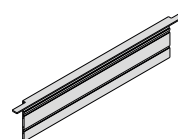

780,- 33,-

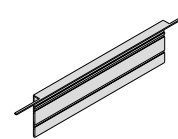

780,- 33,-

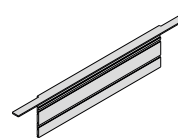

Nadstandardní zakázková výroba, uvedené ceny netto bez možnosti dalších slev. Tolerance délky profilu +10/-10 mm. O možnosti dodání jiných, než uvedených délek se informujte u svého prodejce. Převážné náklady budou kalkulovány individuálně podle objemu zakázky a PSČ.

	Hliník		Stříbrný		Černý	
	cena / ks	EAN	cena / ks	EAN	cena / ks	EAN
90°, 305×305 mm	Kč €	960,- 40,-	130898			
90°, 305×305 mm +LED	Kč €			1290,- 54,-	134421	1350,- 56,- 134452
90°, 305×305 mm flexi R - pravý	Kč €	1960,- 82,-	130904			
90°, 305×305 mm flexi L - levý	Kč €	1960,- 82,-	134414			
90°, 305×305 mm flexi R - pravý + LED	Kč €			2520,- 106,-	134438	2640,- 110,- 134469
90°, 305×305 mm flexi L - levý + LED	Kč €			2520,- 106,-	134445	2640,- 110,- 134476

**Nosný profil 65 mm - schodový díl 90°, varianta s LED, obojí možné v provedení flexi.**

Systémový prvek pro soklování schodových nášlapů. Vnitřní rozměr komponentu 305×305 mm.

U varianty flexi je nutné specifikovat orientaci, zda-li schod při pohledu zespodu směrem ve výstupu navazuje na levotočivý, nebo pravotočivý radius.

Ilustrace „Nosný profil 65 mm schodový“ na straně 346 znázorňuje situaci, kde je použitý Nosný profil 65 mm schodový - pravý.

**Veškeré komponenty pro řady profilů: Soclick Projekt, Soclick LED a Soclick LED Projekt, jako napojení na neviditelné zárubně, flexi provedení, schodové dílce naleznete v klientské zóně kz.neviditelne-zarubne.cz.**

	Hliník	
	cena / ks	EAN
délka 995 mm	Kč €	3530,- 148,- 130911
délka 995 + LED stříbrný	Kč €	4120,- 172,- 130928
délka 995 + LED černý	Kč €	4170,- 174,- 130935

**Soclick FLEXI úprava**

Základní profil v provedení flexi pro soklování rádiusů. Taktéž k dostání ve flexibilní variantě podporující použití LED profilu s difuzorem. LED varianta od vnitřního poloměru rádiusu 80 mm.

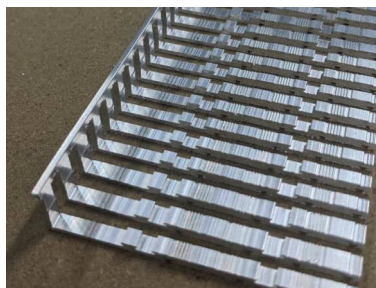

	Hliník	
	cena / ks	EAN
R40, R60 oboustranný, 1000 mm	Kč €	780,- 33,- 130942
C40 oboustranný, 1000 mm	Kč €	780,- 33,- 130959
C60 oboustranný, 1000 mm	Kč €	780,- 33,- 130966

**Nosný profil 65 mm - prvek pro spoj s neviditelnou zárubní Revers 40 mm a 60 mm**

Základní profil celého systému s úpravou pro napojení na Zárubeň MINIMA Revers 40 a 60 mm.

1 m dlouhý pravo-levý prvek. \* u Revers 40 mm nutná úprava drážky pro těsnění.

**Pro kalkulaci počítejte 1 ks/zárubeň.**

**Nosný profil 65 mm - prvek pro spoj s neviditelnou zárubní Classic 40 mm osazení 3 mm**

Základní profil celého systému s úpravou pro napojení na Zárubeň MINIMA Classic 40 mm.

1 m dlouhý pravo-levý prvek. \* u profilů Revers 40 mm i Classic 40 mm je třeba upravit vždy jednu část profilu Neviditelné Zárubně a druhou opatřit příslušenstvím Soclick. Více v návodu.

**Pro kalkulaci počítejte 1 ks/zárubeň.**

**Nosný profil 65 mm - prvek pro spoj s neviditelnou zárubní Classic 60 mm osazení 11,5 mm**

Základní profil celého systému s úpravou pro napojení na Zárubeň MINIMA Classic 60 mm.

1 m dlouhý pravo-levý prvek.

**Pro kalkulaci počítejte 1 ks/zárubeň.**

**Nadstandardní zakázková výroba, uvedené ceny netto bez možnosti dalších slev.** Tolerance délky profilu +10/-10 mm. O možnosti dodání jiných, než uvedených délek se informujte u svého prodejce. Převážné náklady budou kalkulovány individuálně podle objemu zakázky a PSC.

## Soklový systém MINIMA Soclick pro zapuštěné soklové lišty

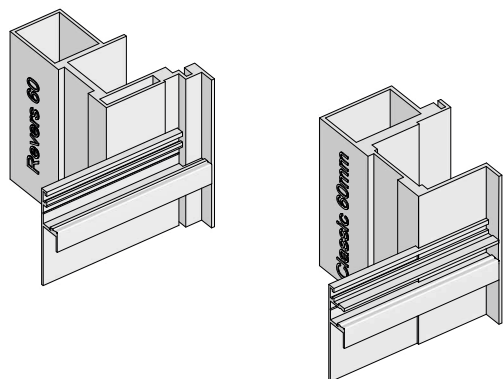

### Click profil napojení na zářež

780,- Kč  
33,- EUR

materiál: hliník  
Kč povrch: přírodní povrch bez eloxu EUR

780,-		33,-
780,-		33,-



### Montážní materiál

790,- Kč  
33,- EUR

Kč EUR

790,-		33,-
1490,-		63,-



### Montážní materiál - profily

Soclick Projekt, Soclick LED,  
Soclick LED Projekt

790,- Kč  
33,- EUR

Kč EUR

790,-		33,-
1490,-		63,-

### Montážní materiál, DEMONTAVATELNÁ výplň lišty - profily

Soclick Projekt, Soclick LED,  
Soclick LED Projekt

1190,- Kč  
50,- EUR

Kč EUR

1190,-		50,-
2290,-		96,-

Nadstandardní zakázková výroba, uvedené ceny netto bez možnosti dalších slev. Tolerance délky profilu +10/ -10 mm. O možnosti dodání jiných, než uvedených délek se informujte u svého prodejce. Převážní náklady budou kalkulovány individuálně podle objemu zakázky a PSČ. Fotky jsou pouze ilustrativní, přesné provedení produktů si prohlédněte u svého prodejce.

		<b>Hliník</b>	
		cena / m	EAN
Click profil 44 mm pro spoj s neviditelnou zárubní, 1000 mm	Kč €	780,- 33,-	130973
Click profil 30 mm pro spoj s neviditelnou zárubní, 1000 mm	Kč €	780,- 33,-	130980

Doplňkový profil umožňující přívod napájecích kabelů k LED páskům s úpravou pro napojení na všechny typy Neviditelných Zárubní MINIMA. 1 m dlouhý pravo-levý prvek.

Pro kombinaci s LED profilem nebo jako nosič pro vkládaný materiál o tloušťce až 4 mm a pro výšku nad 50 mm. Použitím tohoto prvku vzniká komora 6x26 mm pro přívod kabelů k LED páskům. Ideální pro materiály typu - marmoleum, vinyl a koberce.

Pro kombinaci s LED profilem, nebo jako nosič pro vkládaný materiál o tloušťce až 4 mm a pro výšku do 50 mm. Použitím tohoto prvku vzniká komora 6x26 mm pro přívod kabelů k LED páskům. Ideální pro materiály typu - marmoleum, vinyl a koberce.

		cena / balení	EAN
pro 20 bm	Kč €	790,- 33,-	131017
pro 40 bm	Kč €	1490,- 63,-	131024

Montážní materiál běžný pro 10 ks Nosného Profilu 65 mm (~ 20 běžných metrů profilu) obsahuje: 11x úhelník montážní, 11x úhelník pro betonování, 11x vrut vel. hlava, 40x vrut normal, 40x vrut sdk, 51x hmoždinka, plastové podložky 1, 3, 5 mm, hliníkové spojky pro napojování na délku.

Montážní materiál běžný pro 20 ks Nosného Profilu 65 mm (~ 40 běžných metrů profilu) obsahuje: 22x úhelník montážní, 22x úhelník pro betonování, 22x vrut vel. hlava, 80x vrut normal, 80x vrut sdk, 102x hmoždinka, plastové podložky 1, 3, 5 mm, hliníkové spojky pro napojování na délku.

Pro správné osazení Nosného Profilu 65 mm a následné určení finální výšky podlahy je v sadě spojovací materiál pro běžnou i suchou výstavbu, vruty tex, montážní patka a nastavitelný ukazatel výšky betonu. Sada je dodávána automaticky dle typu zvoleného Soclicku a odebrané metráže.

		cena / balení	EAN
pro 20 bm	Kč €	790,- 33,-	156218
pro 40 bm	Kč €	1490,- 63,-	156225

Montážní materiál pro 10 ks profilů Soclick projekt, Soclick LED, Soclick LED projekt ~ 20 běžných metrů profilu) obsahuje: 11x úhelník montážní, 11x úhelník pro betonování, 11x vrut vel. hlava, 40x vrut normal, 40x vrut sdk, 51x hmoždinka, plastové podložky 1, 3, 5 mm, hliníkové spojky pro napojování na délku pomocí šroubů M3.

Montážní materiál běžný pro 20 ks Nosného Profilu 65 mm (~ 40 běžných metrů profilu) obsahuje: 22x úhelník montážní, 22x úhelník pro betonování, 22x vrut vel. hlava, 80x vrut normal, 80x vrut sdk, 102x hmoždinka, plastové podložky 1, 3, 5 mm, hliníkové spojky pro napojování na délku pomocí šroubů M3.

		cena / balení	EAN
pro 20 bm	Kč €	1190,- 50,-	156232
pro 40 bm	Kč €	2290,- 96,-	156249

Montážní materiál pro 10 ks profilů Soclick projekt, Soclick LED, Soclick LED projekt ~ 20 běžných metrů profilu) obsahuje: 11x úhelník montážní, 11x úhelník pro betonování, 11x vrut vel. hlava, 40x vrut normal, 40x vrut sdk, 51x hmoždinka, plastové podložky 1, 3, 5 mm, hliníkové spojky pro napojování na délku pomocí šroubů M3, výseky opakovatelně rozebíratelné pásky 3M. Tato speciální páska umožňuje demontovat a navrátit výplň soklu za účelem přístupu k LED páskům, nebo pro renovaci výplně soklové lišty až 20x. Komponent pro rozebíratelný spoj má celkovou tloušťku 2,5 mm.

Montážní materiál běžný pro 20 ks Nosného Profilu 65 mm (~ 40 běžných metrů profilu) obsahuje: 22x úhelník montážní, 22x úhelník pro betonování, 22x vrut vel. hlava, 80x vrut normal, 80x vrut sdk, 102x hmoždinka, plastové podložky 1, 3, 5 mm, hliníkové spojky pro napojování na délku pomocí šroubů M3, výseky opakovatelně rozebíratelné pásky 3M. Tato speciální páska umožňuje demontovat a navrátit výplň soklu za účelem přístupu k LED páskům, nebo pro renovaci výplně soklové lišty až 20x. Komponent pro rozebíratelný spoj má celkovou tloušťku 2,5 mm.

**Nadstandardní zakázková výroba, uvedené ceny netto bez možnosti dalších slev.** Tolerance délky profilu +10/-10 mm. O možnosti dodání jiných, než uvedených délek se informujte u svého prodejce. Převážné náklady budou kalkulovány individuálně podle objemu zakázky a PSC. Fotky jsou pouze ilustrativní, přesné provedení produktů si prohlédněte u svého prodejce.

## System MINIMA Soclick pro zděné příčky



1. Nosný profil 65 mm - schodový díl 90°
2. Minima Revers 60 mm
3. M&T madlo YES!
4. Nosný profil 65 mm- prvek pro spoj s neviditelnou zárubní Revers 60 mm - osazení 11,5 mm
5. LED profil - prvek pro spoj s neviditelnými zárubněmi Classic a Revers 60 mm
6. M&T Magnetic
7. LED profil
8. Vkládaný materiál o výšce 45 mm\*

## System MINIMA Soclick pro sádkartonové konstrukce

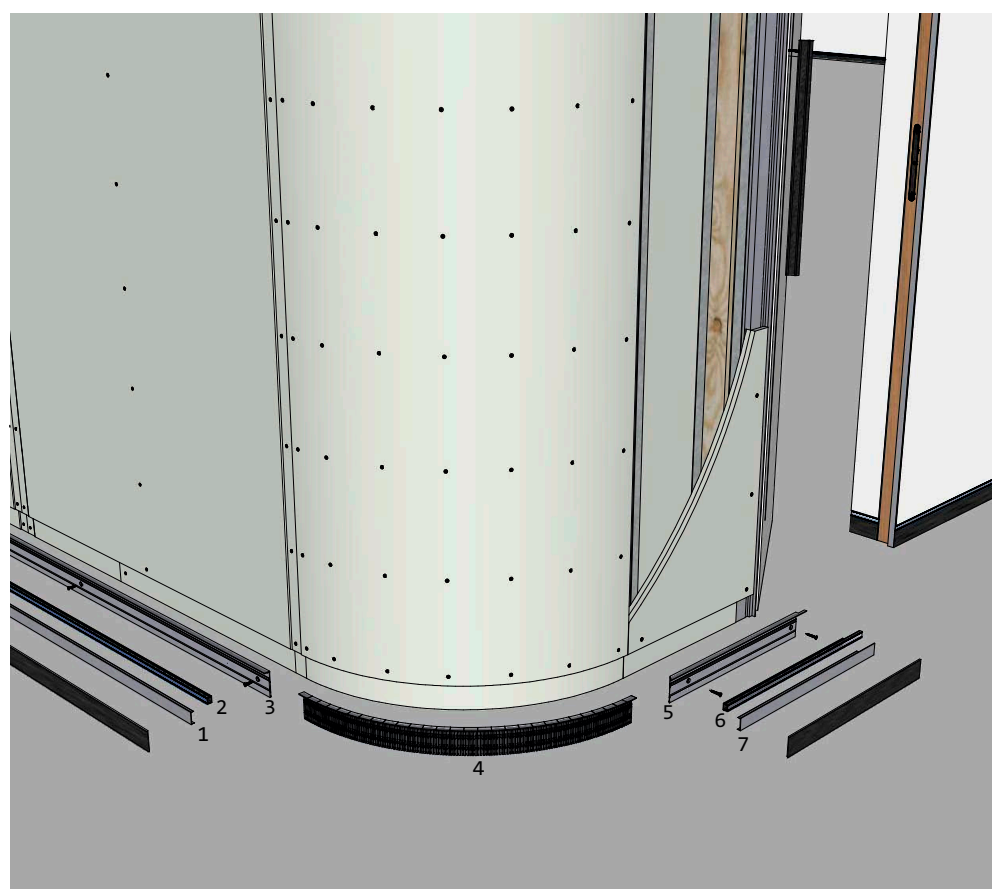

1. Profil click 30 mm
2. LED profil černě eloxovaný - možno s černým difuzorem
3. Nosný profil 65 mm
4. Nosný profil 65 mm - Flexi + LED
5. Nosný profil 65 mm - prvek pro spoj s neviditelnou zárubní Revers 60 mm - osazení 11,5 mm
6. LED profil - prvek pro spoj s neviditelnými zárubněmi Classic a Revers 60 mm
7. Click profil 30 mm - prvek pro spoj s neviditelnou zárubní

**System Soclick - napojení na neviditelné zárubně Classic 40 mm - objednací kód: 130959**

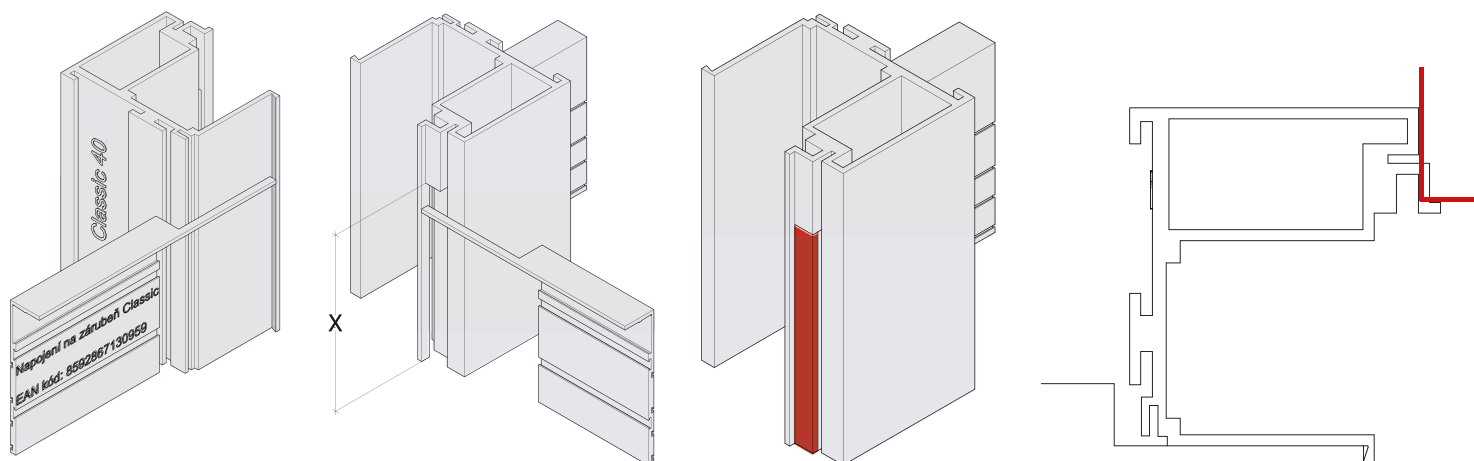

Rozměr osazení „X” je nutné určit dle výšky finální krytiny a výšky Nosného profilu 65 mm + rezerva.

Osy řezu osazení pro Nosný profil 65 mm.

**System Soclick - napojení na neviditelné zárubně Revers 40 mm - objednací kód: 130042**

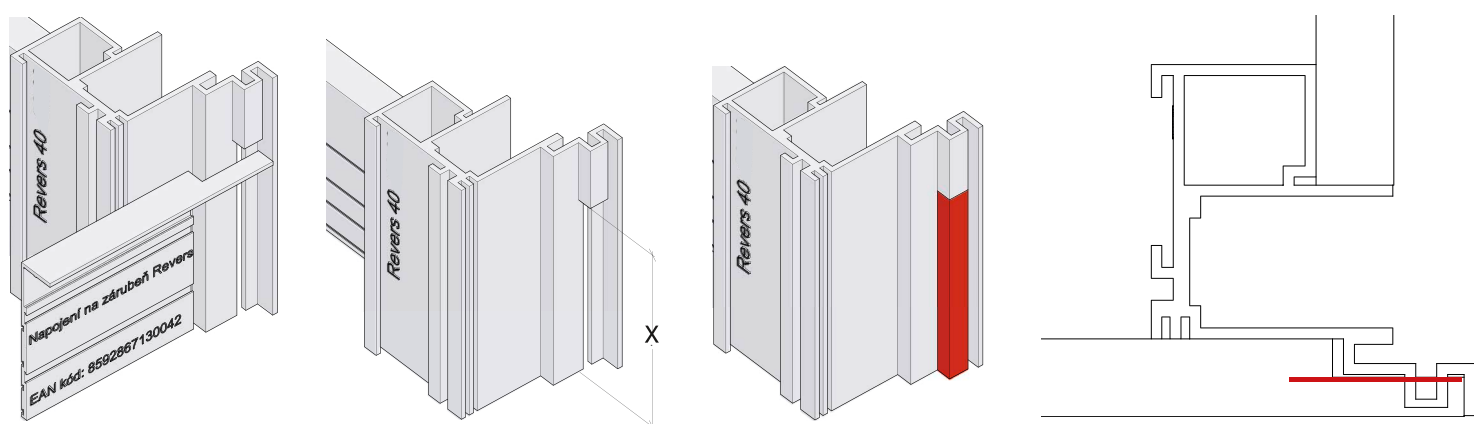

Rozměr osazení „X” je nutné určit dle výšky finální krytiny a výšky Nosného profilu 65 mm + rezerva.

Osy řezu osazení pro Nosný profil 65 mm.

**Napojení na neviditelné zárubně Revers 60 mm  
objednací kód: 130042**

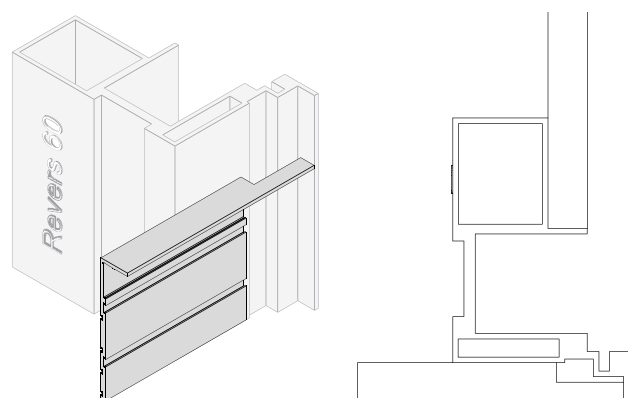

**Napojení na neviditelné zárubně Classic 60 mm  
objednací kód: 130966**

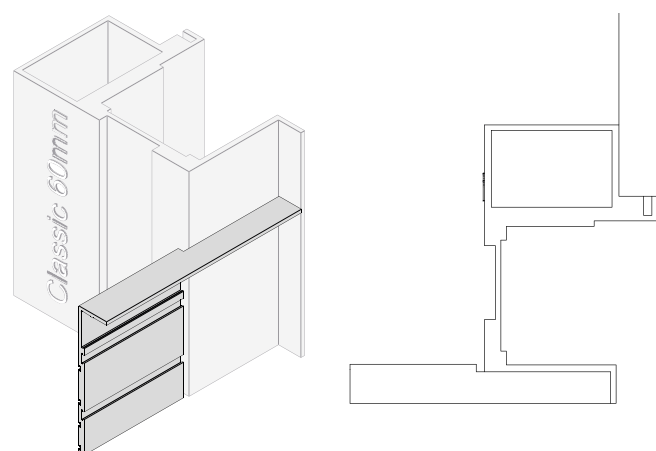

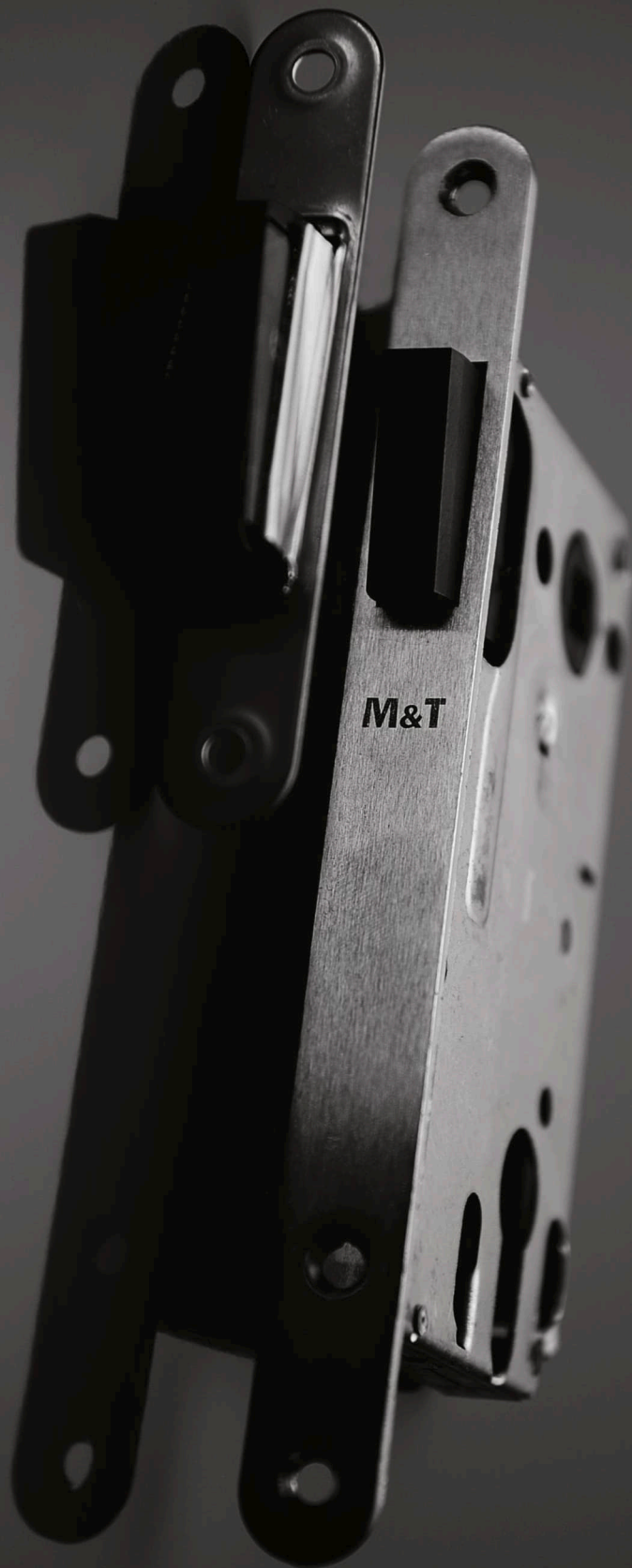

Příbuzný sortiment

Dveřní kliky NEREZ



Dveřní kliky DESIGN 2000, 2004



Dveřní kliky DESIGN 2006



Dveřní kliky DESIGN 2009



Dveřní kliky DESIGN 2011  
řada MINI



Dveřní kliky DESIGN 2012  
ploché rozety



Dveřní kliky DESIGN 2012  
zapuštěné rozety



Dveřní kliky a kování DESIGN 2013  
řada MINIMAL/MAXIMAL





## Magnetické zámky

Povrchy: **broušený chrom Cr - broušeno, lesklý chrom Cr, černý K, stříbrný matný STř, bílý Wh**

Magnetické zámky přinášejí uživatelský komfort při obsluze dveří. Magnetické zámky M&T jsou konstrukčně připraveny jak pro polodrážkové/falcové, tak bezfalcové dveře. Vítanou inovací je seřiditelný protiplech pro bezfalcové dveře. Předností je barevnostní nabídka povrchů zámků, která koresponduje s povrchy dveřních klik. Zámky jsou připraveny ve všech variantách zamykání.

### Magnetický zámek

Standard



### Protiplech

seřiditelný do stran

24 mm

22 mm



konstrukční varianty, materiálové provedení

- stejný rozměr a zádlab do dveří pro zámek standard
- zavírání dveří bez použití kliky ... stačí pouze do dveří strčit a dveře se přesně dovřou
- bezchybná funkce střešky zámku ... zámek je vysoce spolehlivý, bez možnosti zablokování dveří
- povrchy broušený chrom, lesklý chrom, černý matný, stříbrný matný, bílý
- garantovaná životnost 150 000 cyklů
- nabízené zámky jsou zámky interiérové, mezipokojevé - nevhodné pro vstupní dveře do objektů
- lze dodat i magnetické zámky do zátěžového prostředí

Doporučené použití při montáži kování

Po vrtání otvorů pro rozetové kování PROFÍ šablonou M&T skrze dveře, vyjměte zámek ze dveří. Zámek vyčistěte od dřevěných pilin a čistý namontujte zpět do dveří. Dřevěné piliny mohou mít za následek nepřesnou funkci zámku a klik. Zámek nemazat tuky, které „zalepí“ zámek.





Cr lesklý chrom dozický



K černý matný WC

**Zámek Standard**

410,- Kč  
18,- EUR



Cr - broušeno broušený chrom cylindrický

**Kč** povrch: Cr chrom broušeno **EUR**

410,-		18,-
410,-		18,-
410,-		18,-



**Seřiditelný protiplech 24 mm magnet**

270,- Kč  
12,- EUR

**Seřiditelný protiplech 22 mm magnet**

300,- Kč  
13,- EUR

**Kč** povrch: Cr chrom broušeno **EUR**

270,-		12,-
-------	--	------

**Kč** povrch: Cr chrom broušeno **EUR**

300,-		13,-
-------	--	------

		Cr - broušeno		Cr lesklý chrom		K černý matný		STŘ stříbrný matný		Wh bílý	
		cena / ks	EAN	cena / ks	EAN	cena / ks	EAN	cena / ks	EAN	cena / ks	EAN
dozický	Kč €	410,- 18,-	49307	410,- 18,-	49390	480,- 20,-	080902	370,- 16,-	080933	480,- 20,-	080964
cyklindrický	Kč €	410,- 18,-	49314	410,- 18,-	49406	480,- 20,-	080919	370,- 16,-	080940	480,- 20,-	080971
WC	Kč €	410,- 18,-	49383	410,- 18,-	49420	480,- 20,-	080926	370,- 16,-	080957	480,- 20,-	080988

Uváděné zámky jsou zámky interiérové, mezipokojové - nevhodné pro vstupní dveře do objektů.  
Cylindrické zámky nelze použít ke kombinaci koule/klika.

		Cr - broušeno		Cr lesklý chrom		K černý matný		STŘ stříbrný matný		Wh bílý	
		cena / ks	EAN	cena / ks	EAN	cena / ks	EAN	cena / ks	EAN	cena / ks	EAN
	Kč €	270,- 12,-	49192	270,- 12,-	49208	350,- 15,-	080995	270,- 12,-	081008	350,- 15,-	081015

Seřiditelný protiplech lze použít pouze na bezfalcové dveře. Šířka protiplechu je 24 mm. Seřízení do stran  $\pm 1$  mm.

		Cr - broušeno		Cr lesklý chrom		K černý matný		STŘ stříbrný matný		Wh bílý	
		cena / ks	EAN	cena / ks	EAN	cena / ks	EAN	cena / ks	EAN	cena / ks	EAN
	Kč €	300,- 13,-	086522	300,- 13,-	086515	300,- 13,-	081022	240,- 10,-	081039	300,- 13,-	081046

Seřiditelný protiplech lze použít pouze na bezfalcové dveře. Šířka protiplechu je 22 mm. Seřízení do stran  $\pm 1,5$  mm.

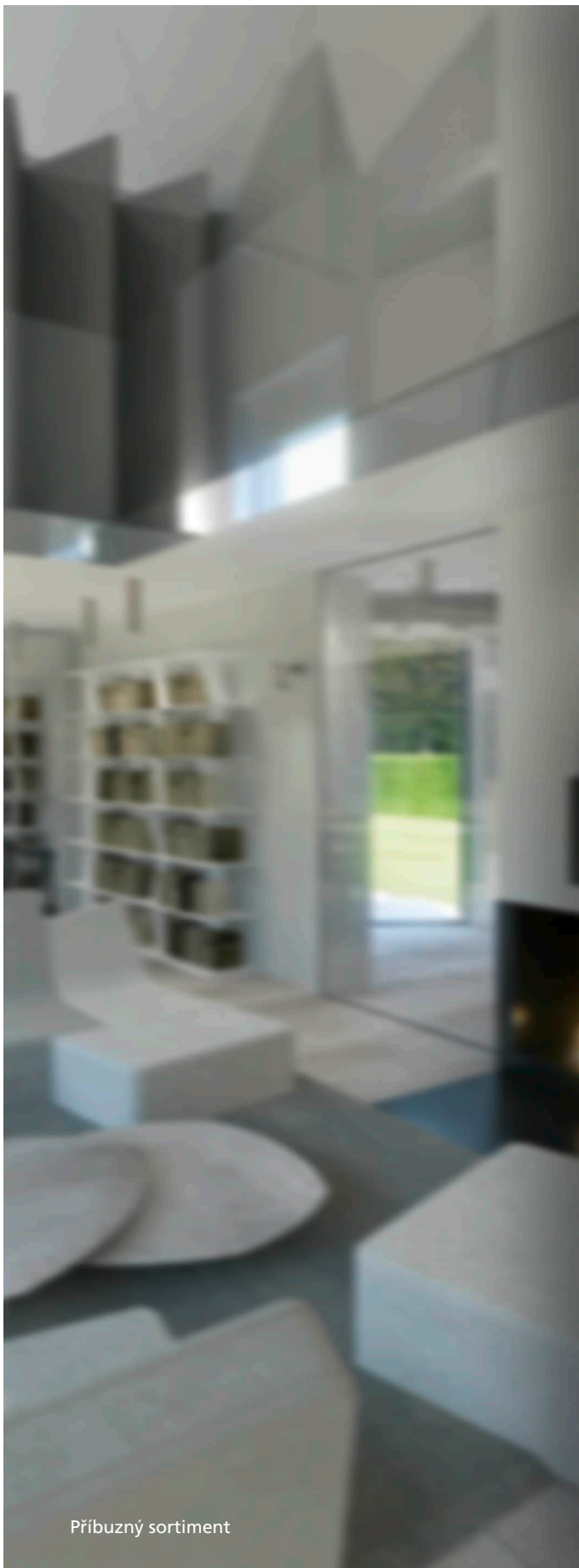

Příbuzný sortiment



Dveřní kliky NEREZ



Dveřní kliky DESIGN 2011  
řada MINI



Dveřní kliky DESIGN 2000, 2004



Dveřní kliky DESIGN 2012  
ploché rozety



Dveřní kliky DESIGN 2006



Dveřní kliky DESIGN 2012  
zapuštěné rozety



Dveřní kliky DESIGN 2009



Dveřní kliky a kování DESIGN 2013  
řada MINIMAL/MAXIMAL



## Panty na dřevěné dveře

Materiál: ocel  
Povrchy: SNI, Cr, TiN-K

Minimalistické hranaté panty jsou ideálním doplňkem dveří k hranatým klikám. Tento příznavý detail dodává dveřím koncepčnost a vyšší užitnou hodnotu. Pro oblíbené černé kliky je v nabídce také kulatý černý pant pro sladění interiéru.

MINI **SNI** matný nikl



MINI **TiN-K** titan černý mat



KULATÝ **TiN-K** titan černý mat



### konstrukční varianty

- doporučená nosnost pantů Mini .. 2 ks do hmotnosti dveřního křídla 40 kg
- panty jsou konstrukčně řešeny pro snadnou montáž na dveřní křídlo, stejně jako používané standardní panty
- záruka 3 roky, titany 15 let

roky **3 garance** let **15 garance**

Ochranné známky – registrované značky

MINI®





**SNi** matný nikel



**Cr** lesklý chrom



**TiN-K** titan černý mat

**Pant Mini**

400,- Kč  
17,- EUR

Kč	materiál: ocel povrch: SNi matný nikel	EUR
400,-		17,-
400,-		17,-



**TiN-K** titan černý mat

**Kulatý pant**

230,- Kč  
9,6 EUR

Kč	materiál: ocel povrch: TiN-K titan černý mat	EUR
230,-		9,6



**SNi** matný nikel



**Cr** lesklý chrom

**Krytka pantu**

170,- Kč  
7,1 EUR

Kč	materiál: masivní mosaz povrch: SNi matný nikel	EUR
170,-		7,1



**TiN-S** titan bronz mat

		Sni		Cr		TiN-K	
		cena / ks	EAN	cena / ks	EAN	cena / ks	EAN
pravý R	Kč €	400,- 17,-	86999	540,- 23,-	87019	670,- 28,-	87033
levý L	Kč €	400,- 17,-	87002	540,- 23,-	87026	670,- 28,-	87040

		TiN-K	
		cena / ks	EAN
	Kč €	230,- 9,6	070569

		Sni		Cr		Ms		Ms-L		TiN-C		TiN-K		TiN-B		TiN-A	
		cena	EAN	cena	EAN	cena	EAN	cena	EAN	cena	EAN	cena	EAN	cena	EAN	cena	EAN
		pár		pár		pár		pár		pár		pár		pár		pár	
Ø 15 mm dl. 48 mm	Kč €	170,- 7,1	72985	170,- 7,1	72992	440,- 19,-	062564	440,- 19,-	062571	310,- 13,-	73012	370,- 16,-	73029	370,- 16,-	91962	370,- 16,-	73036

Krytka je připravena ke standardním pantům TKZ Trio průměr 15 mm. Povrch TiN-A je matný, **nebroušený**.



TiN-C titan chrom mat



TiN-B titan braun mat



TiN-A titan mosaz mat



TiN-K titan černý mat



Příbuzný sortiment

Dveřní kliky NEREZ



Dveřní kliky DESIGN 2000, 2004



Dveřní kliky DESIGN 2006



Dveřní kliky DESIGN 2009



Dveřní kliky DESIGN 2011  
řada MINI



Dveřní kliky DESIGN 2017  
magnetické rozety



Dveřní kliky NEREZ + magnetické rozety



Dveřní kliky a kování DESIGN 2013  
řada MINIMAL/MAXIMAL





## Dveřní zarážky

Materiál: ocel, mosaz, TPE, masivní dřevo

Povrchy: SNI, Cr, SNI-broušeno, TiN-C, TiN-B, TiN-K, Ms, Ms-A, Ms-L, zakázkově TiN-A, TiN-S

více info na [www.kliky-mt.cz/manufaktura/barvy-povrchy](http://www.kliky-mt.cz/manufaktura/barvy-povrchy)

Dveřní zarážky M&T v navržených designech splňují i náročné požadavky investorů pro dokonalé sladění interiérů s dveřním kováním v jednotném designu i požadované barevnosti. Podobně tak i zarážky Wood z masivního dřeva s kovovou konstrukcí. Zarážky Minimal / Maximal jsou jasnou volbou pro milovníky designu, kde i na takovém detailu jakou je dveřní zarážka, lze navrhnout svůj osobitý design vložení libovolného materiálu do pohledové části zarážky. Zarážku Multi díky své struktuře a plasticitě lze použít jak na podlahu, tak i na stěnu (materiál TPE - termoplastický elastomer).

LUSY



BURAK



MINIMAL / MAXIMAL



MULTI



WOOD



### konstrukční varianty

- Lusy, Burak, Minimal / Maximal, Multi, Wood pro montáž do podlahy pomocí hmoždinky
- zarážka Multi s montáží i do stěny
- v nabídce také přídržovač M&T s hmotností 1,4 kg bez montáže na hmoždinku
- záruka 3 roky, titany 15 let

roky

**3 garance**

let

**15 garance**

Ochranné známky – registrované značky



**MINIMAL®**  
**MAXIMAL®**

Chráněné průmyslové vzory zarážka



**MINIMAL**  
**MAXIMAL**



SNi matný nikel



**Dveřní zarážka Lusy**

390,- Kč  
17,- EUR

Kč	materiál: ocel povrch: SNi matný nikel	EUR
390,-		17,-



**Dveřní zarážka Burak**

300,- Kč  
13,- EUR

Kč	materiál: ocel povrch: SNi matný nikel	EUR
300,-		13,-



**Přidržovač dveří**

730,- Kč  
31,- EUR

Kč	materiál: ocel povrch: SNi matný nikel	EUR
730,-		31,-



jasan



ořech

**Dveřní zarážka Wood**

600,- Kč  
25,- EUR

Kč	materiál: masivní dřevo + ocel povrch: olejováno	EUR
600,-		25,-



bělený dub



dub

		Sni		NRz		Cr		TiN-C		TiN-K	
		cena / ks	EAN	cena / ks	EAN	cena / ks	EAN	cena / ks	EAN	cena / ks	EAN
výška / průměr 30 / 40 mm	Kč €	390,- 17,-	26001	390,- 17,-	43268	390,- 17,-	25981	520,- 22,-	25967	670,- 28,-	26285
výška / průměr 40 / 40 mm	Kč €	400,- 17,-	26018	400,- 17,-	43329	400,- 17,-	25998	550,- 23,-	25974	700,- 30,-	25950

		Sni		Cr	
		cena / ks	EAN	cena / ks	EAN
výška / průměr 25 / 45 mm	Kč €	300,- 13,-	72862	300,- 13,-	72879

		Sni		Cr		TiN-C		TiN-K	
		cena / ks	EAN	cena / ks	EAN	cena / ks	EAN	cena / ks	EAN
výška / průměr 42 / 80 mm	Kč €	730,- 31,-	78352	730,- 31,-	78369	1020,- 43,-	78383	1180,- 50,-	78390

Přidržovač dveří s hmotností 1,4 kg se nevtá do podlahy, pouze se na podlahu pokládá. Na spodní straně je opatřen protiskluzným materiálem, který zabraňuje snadnému posouvání po podlaze a zároveň jakémukoliv poškrábání podlahy.

		Teak		Dub		Ořech		Jasan		Bělený dub	
		cena / ks	EAN	cena / ks	EAN	cena / ks	EAN	cena / ks	EAN	cena / ks	EAN
	Kč €	600,- 25,-	028423	540,- 23,-	028430	540,- 23,-	028447	540,- 23,-	028454	580,- 25,-	028461

Zarážky Wood jsou vyráběny z masivního dřeva s kovovou konstrukcí garantující dlouhodobou životnost. Standardně dodáváno s černou gumou, možnost dodání s gumou šedou nebo čírou.



SNi matný nikel



Ti-B titan braun mat



Ms mosaz natural



MAXIMAL SNI matný nikel  
výplň kůže - hnědá čokoládová



**Dveřní zarážka**

**Minimal**

710,- Kč  
30,- EUR



Cr lesklý chrom

materiál: masivní mosaz  
povrch: SNI matný nikel

Kč

EUR

710,-



30,-



TiN-K titan černý mat

**Dveřní zarážka**

**Maximal**

780,- Kč  
33,- EUR

materiál: masivní mosaz  
povrch: SNI matný nikel

Kč

EUR

780,-



33,-

**Výplň zarážky  
Maximal**

89,- Kč  
3,8 EUR



materiál: TPE  
povrch: různé barvy

Kč

EUR

400,-

17,-

**Dveřní zarážka MULTI**

400,- Kč  
17,- EUR



	<b>SNi</b>		<b>SNi - broušeno</b>		<b>Cr</b>		<b>Ms</b>		<b>Ms-A</b>		
	cena ks	EAN	cena ks	EAN	cena ks	EAN	cena ks	EAN	cena ks	EAN	
Minimal	Kč €	710,- 30,-	003277	780,- 33,-	003284	790,- 33,-	003291	790,- 33,-	062588	920,- 39,-	101218

	<b>TiN-C</b>		<b>TiN-B</b>		<b>TiN-K</b>		<b>TiN-A</b>		
	cena ks	EAN	cena ks	EAN	cena ks	EAN	cena ks	EAN	
Minimal	Kč €	920,- 39,-	003307	1080,- 45,-	003314	1080,- 45,-	003321	1080,- 45,-	003338

Standardně dodáváno s černou gumou, možnost dodání s gumou šedou nebo čirou.



Ms-A mosaz antik



TiN-A titan mosaz mat



	<b>SNi</b>		<b>SNi - broušeno</b>		<b>Cr</b>		<b>Ms</b>		<b>Ms-A</b>		
	cena ks	EAN	cena ks	EAN	cena ks	EAN	cena ks	EAN	cena ks	EAN	
Maximal	Kč €	780,- 33,-	003345	830,- 35,-	003352	860,- 36,-	003369	860,- 36,-	062601	1000,- 42,-	101386

	<b>TiN-C</b>		<b>TiN-B</b>		<b>TiN-K</b>		<b>TiN-A</b>		
	cena ks	EAN	cena ks	EAN	cena ks	EAN	cena ks	EAN	
Maximal	Kč €	1000,- 42,-	003376	1150,- 48,-	003383	1150,- 48,-	003390	1000,- 42,-	003406

	cena ks	EAN	
dřevo	Kč €	89,- 3,8	003413
kov	Kč €	89,- 3,8	003420
kůže	Kč €	130,- 5,5	003437
efekt „sklo“	Kč €	130,- 5,5	003444
RAL barvy	Kč €	150,- 6,3	022537

	<b>Bílá</b>		<b>Černá</b>		<b>Hnědá</b>		
	cena ks	EAN	cena ks	EAN	cena ks	EAN	
MULTI	Kč €	400,- 17,-	030778	400,- 17,-	030785	400,- 17,-	030792

Barevný odstín si ověřte u vašeho prodejce podle fyzického vzorku zarážky.



Příslušenství montážní šablony (lze objednat i samostatně)

**určeno pro každého montážníka**



profi-montážní utahovák  
červíků "červák" EAN 65499 cena 210,- Kč / 8,8 EUR

bit-imbus 3  
k červíku M6 pro montáž všech typů  
klik / rukojetí M&T  
EAN 65475 cena 55,- Kč / 2,3 EUR

bit-imbus 2 k červíku M4  
pro montáž rozet Minimal a dalších  
komponentů M&T  
EAN 91955 cena 55,- Kč / 2,3 EUR

bit-imbus 2,5 k červíku M5  
pro montáž všech  
WC mechanismů M&T  
EAN 65482 cena 55,- Kč / 2,3 EUR

## Montážní PROFI šablona

Použití: univerzální pro všechny typy zámků, na veškeré rozetové kování M&T

Montážní PROFI šablona M&T je určena pro vrtání přesných otvorů sloužících k rychlé a kvalitní montáži veškerého rozetového kování M&T. Jedinečná konstrukce vrtací šablony je připravena pro univerzální použití na všechny rozměry/rozteče dveřních zámků, které jsou dostupné na trhu. Zároveň je ihned použitelná pro všechny typy/varianty zámků. Dodává se v sadě s PROFI montážním utahovákem, sadou bitů a zajišťovacím gelem proti uvolnění šroubových spojů.

PROFI šablona M&T



kompletní montážní kufřík s PROFI šablonou M&T



### konstrukční varianty, materiálové provedení

- dokonalá konstrukce pro naprosto přesné vrtání požadovaných otvorů
- pohyblivé bloky šablony pro vrtání zámků všech rozměrů
- fixace polohy šablony bočními červíky pro opakované vrtání většího počtu stejných dveří
- zaslepovací magnetky pro eliminaci chybného vrtání
- celý sortiment rozetového kování M&T montován pomocí jedné univerzální PROFI šablony M&T
- PROFI šablona určena i pro bezpečnostní rozety
- vodící čep pro cylindrickou vložku lze nastavovat podle tl. dveří
- součástí montážního kufříku je sada všech potřebných vrtáků
- v sadě je dále PROFI montážní utahovák, sada bitů, zajišťovací gel
- přehledná animace montáže s veškerým použitím šablony

Patent

celková konstrukce šablony a systém použití

patent

Univerzální PROFI šablona M&T by neměla chybět u žádného prodejce, u žádného montážníka pracujícího s kvalitními produkty M&T.

Samozřejmostí je možnost zapůjčení PROFI šablony k montáži rozetového kování M&T všem prodejcům, montážníkům a koncovým zákazníkům viz. informace na [www.kliky-mt.cz/montaze-kovani](http://www.kliky-mt.cz/montaze-kovani).



kufřík s vrtací PROFI šablonou + PROFI utahovákem  
EAN 90255 cena 2670,- Kč / 112 EUR



Animace použití šablony  
nebo na [www.kliky-mt.cz/montaze-kovani](http://www.kliky-mt.cz/montaze-kovani)

## Příslušenství a komponenty

Veškeré uváděné komponenty slouží pro dokonalý servis a dlouhodobou funkčnost a životnost kování. Komponenty M&T nejsou standardním obchodním artiklem a neposkytují se na ně obchodní slevy.

Pouzdro	cena ks	EAN
25 mm	Kč € 17,- 0,8	18099
40 mm	Kč € 28,- 1,2	007190
53 mm	Kč € 36,- 1,5	007206

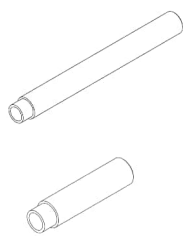

Šrouby M4 k pouzdrům	cena ks	EAN
4 x 16 mm	Kč € 4,- 0,2	034783
4 x 35 mm	Kč € 5,- 0,3	034790
4 x 50 mm	Kč € 6,- 0,3	034806

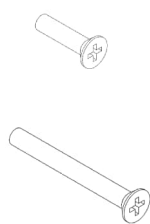

Vrutky ke štítkům	cena ks	EAN
SNi	Kč € 4,- 0,2	034875
NRz	Kč € 5,- 0,3	034882
černé	Kč € 4,- 0,2	034899

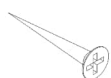

Pružina	cena ks	EAN
	Kč € 13,- 0,6	50365



Rozpěrný čtyřhran pro jednostrannou kliku	cena ks	EAN
□ 8 x 8 mm délka od osy zámku 50 mm	Kč € 400,- 17,-	30206
□ 8 x 8 mm délka od osy zámku 70 mm	Kč € 490,- 21,-	14213
□ 8 x 8 mm délka od osy zámku 90 mm	Kč € 540,- 23,-	035247
□ 8 x 8 mm / 10 x 10 mm délka od osy zámku 50 mm	Kč € 540,- 23,-	30268
□ 8 x 8 mm / 10 x 10 mm délka od osy zámku 70 mm	Kč € 670,- 28,-	035254
□ 8 x 8 mm / 10 x 10 mm délka od osy zámku 90 mm	Kč € 800,- 34,-	035261

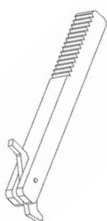

Rozpěrný čtyřhran se rozpírá / fixuje v ořechu zámku, ne za zámkem. Více informací na [www.kliky-mt.cz/montaze-kovani](http://www.kliky-mt.cz/montaze-kovani).

Kroužek pojistný (ségrovka)	cena ks	EAN
Ø 14	Kč € 6,- 0,3	50457



Plastové podrozety pod rukojeti (vnitřní)	cena pár	EAN
design 2000	Kč € 55,- 2,2	034813
design 2004	Kč € 61,- 2,6	034820
design 2006	Kč € 130,- 5,5	034837
design 2009	Kč € 130,- 5,5	034844
design 2011 / 2013	Kč € 130,- 5,5	034851

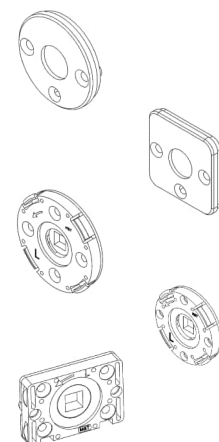

Šrouby M4 k pouzdrům Mini, Minimal, Maximal	cena ks	EAN
4 x 16 mm	Kč € 8,- 0,4	082340
4 x 35 mm	Kč € 9,- 0,4	082357
4 x 50 mm	Kč € 11,- 0,5	082364

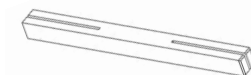
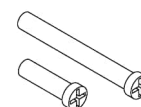

Čtyřhran s drážkou □ 8 x 8 mm	Ocel cena / ks	EAN	Nerez cena / ks	EAN
80 mm	Kč € 34,- 1,5	28111	73,- 3,1	034622
83 mm	Kč € 34,- 1,5	034578	73,- 3,1	034639
85 mm	Kč € 34,- 1,5	50013	73,- 3,1	034646
90 mm	Kč € 34,- 1,5	28128	73,- 3,1	034653
95 mm	Kč € 34,- 1,5	50020	73,- 3,1	034660
100 mm	Kč € 41,- 1,8	28135	81,- 3,4	034677
105 mm	Kč € 49,- 2,1	50037	95,- 4,0	034684
110 mm	Kč € 55,- 2,3	28142	110,- 4,6	034691
120 mm	Kč € 61,- 2,6	28159	130,- 5,5	034707
130 mm	Kč € 68,- 2,9	28166	150,- 6,3	034714
140 mm	Kč € 76,- 3,2	28173	160,- 6,7	034721
150 mm	Kč € 81,- 3,4	28180	170,- 7,1	034738
160 mm	Kč € 88,- 3,7	034585	180,- 7,5	034745
170 mm	Kč € 95,- 4,0	034592	200,- 8,4	034752
180 mm	Kč € 110,- 4,6	034608	210,- 8,8	034769
190 mm	Kč € 110,- 4,6	034615	230,- 9,6	034776



Imbus klíč	cena ks	EAN
2	Kč € 7,- 0,3	034905
2,5	Kč € 8,- 0,4	50501
3	Kč € 9,- 0,4	27114

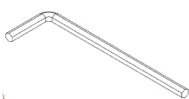

Protiplech různé typy podle typu kliky	cena ks	EAN
	Kč € 11,- 0,5	035063



Zajišťovač šroubových spojů	cena ks	EAN
0,5 ml	Kč € 61,- 2,6	034929
5 ml	Kč € 110,- 4,6	40090



Plastové podložky ke klikám	cena ks	EAN
černá	Kč € 8,- 0,4	043167
šedá	Kč € 8,- 0,4	043174



Různé druhy podle typu kliky.

Vložka závěsu kovová	cena ks	EAN
pro pant Metrik	Kč € 67,- 2,8	73111

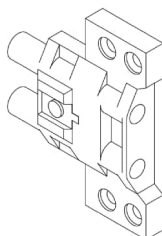

Okenní mechanismus	cena ks	EAN
kovový 37 mm	Kč € 150,- 6,3	119770
kovový 42 mm	Kč € 150,- 6,3	119787
kovový 50 mm	Kč € 160,- 6,7	119794
kovový 61 mm	Kč € 180,- 7,5	119800
plastový	Kč € 58,- 2,5	90309

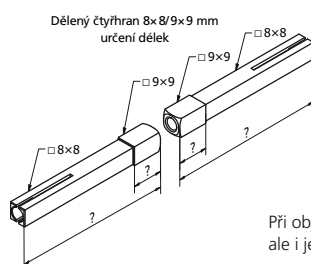
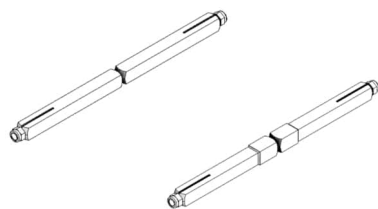
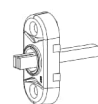

Montážní materiál pro rozetové kování	cena sada	EAN
tl. dveří 46-55 mm	Kč € 41,- 1,8	27978
56-71 mm	Kč € 81,- 3,4	27985
72-85 mm	Kč € 160,- 6,7	28005
86-126 mm	Kč € 230,- 9,6	91153

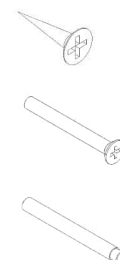

Montážní materiál pro sešroubování skrze dveře pro štitové kování	cena sada	EAN
tl. dveří 38-45 mm	Kč € 55,- 2,3	066401
46-55 mm	Kč € 81,- 3,4	066418
56-71 mm	Kč € 110,- 4,6	066425
72-85 mm	Kč € 160,- 6,7	066432
86-126 mm	Kč € 230,- 9,6	066449



Čtyřhran WC □ 6 x 6 mm	cena ks	EAN
45 mm	Kč € 14,- 0,6	035018
53 mm	Kč € 14,- 0,6	035025
63 mm	Kč € 15,- 0,7	50068
66 mm	Kč € 16,- 0,7	035032
70 mm	Kč € 17,- 0,8	50075
80 mm	Kč € 21,- 0,9	035049
85 mm	Kč € 23,- 1,0	035056

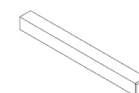

Červíky	Nerez cena / ks	EAN	Černý cena / ks	EAN
M4x4 plochý	Kč € 13,- 0,6	035148	7,- 0,3	035155
M4x5 plochý	Kč € 13,- 0,6	035162	7,- 0,3	035179
M4x6 plochý	Kč € 15,- 0,7	035186	8,- 0,4	035193
M5x6 s hrotem	Kč €		8,- 0,4	50495
M6x7 s nosem	Kč € 17,- 0,8	035216		
M6x8 s hrotem	Kč € 17,- 0,8	035223		
M6x10 s nosem	Kč €		13,- 0,6	50488



Při objednání děleného čtyřhranu je třeba upřesnit nejen celkovou délku, ale i jednotlivé dílčí délky jednotlivých částí čtyřhranu.

Dělený čtyřhran	45/40 mm	EAN	45/50 mm	EAN	55/50 mm	EAN	60/60 mm	EAN	70/70 mm	EAN	70/75 mm	EAN	75/75 mm	EAN
	cena / ks		cena / ks		cena / ks		cena / ks		cena / ks		cena / ks		cena / ks	
□ 8x8 / 9x9 mm	Kč € 540,- 23,-	74408	600,- 25,-	079982	600,- 25,-	74422	670,- 28,-	74446	730,- 31,-	080001	730,- 31,-	080025	730,- 31,-	062700
□ 8x8 mm	Kč € 490,- 21,-	74392	550,- 23,-	079999	550,- 23,-	74415	610,- 26,-	74439	670,- 28,-	080018	670,- 28,-	080032	670,- 28,-	062694

Rozety Design 2000, 2004		SNi cena / pár	EAN	SNi - br. cena / pár	EAN	Cr cena / pár	EAN	TiN-S cena / pár	EAN	TiN-C cena / pár	EAN	TiN-K cena / pár	EAN	TiN-A cena / pár	EAN
kulatá dozická	Kč €	110,- 4,6	034936	110,- 4,6	037357	210,- 8,8	037142	440,- 19,-	034950	440,- 19,-	037180	440,- 19,-	037210	440,- 19,-	037241
kulatá cylindrická	Kč €	110,- 4,6	037128	110,- 4,6	037364	210,- 8,8	037159	440,- 19,-	037173	440,- 19,-	037197	440,- 19,-	037227	440,- 19,-	037258
kulatá WC	Kč €	810,- 34,-	104165	810,- 34,-	104196	950,- 40,-	104219	1170,- 49,-	104233	1170,- 49,-	104257	1170,- 49,-	104271	1170,- 49,-	104349
čtvercová dozická	Kč €	210,- 8,8	034943	210,- 8,8	037388	300,- 13,-	037166	540,- 23,-	034967	540,- 23,-	037203	540,- 23,-	037234	540,- 23,-	037265
čtvercová cylindrická	Kč €	210,- 8,8	037135	210,- 8,8	72152	300,- 13,-	72176	540,- 23,-	72190	540,- 23,-	72213	540,- 23,-	72237	540,- 23,-	72251
čtvercová WC	Kč €	1010,- 43,-	104172	1010,- 43,-	104202	1150,- 48,-	104226	1380,- 58,-	104240	1380,- 58,-	104264	1380,- 58,-	104288	1380,- 58,-	104356

Spodní krycí rozety včetně plast. podrozet a vrutů (EAN spodních rozet dalších designových řad jsou uvedeny v tabulkách přímo u dveřních klik).

Rozety NRz	NRz cena / pár	EAN	Objekt titan	K-industrial			
			cena / pár	EAN	cena / pár	EAN	
kulatá dozická	Kč €	110,- 4,6	034974	410,- 18,-	034998	410,- 18,-	037296
kulatá cylindrická	Kč €	110,- 4,6	037272	410,- 18,-	037333	410,- 18,-	037302
kulatá WC	Kč €	560,- 24,-	104363	860,- 36,-	105209	860,- 36,-	138559
čtvercová dozická	Kč €	200,- 8,4	034981	500,- 21,-	035001	500,- 21,-	037319
čtvercová cylindrická	Kč €	200,- 8,4	037289	500,- 21,-	037340	500,- 21,-	037326
čtvercová WC	Kč €	720,- 30,-	105193	1070,- 45,-	105216	1070,- 45,-	138566

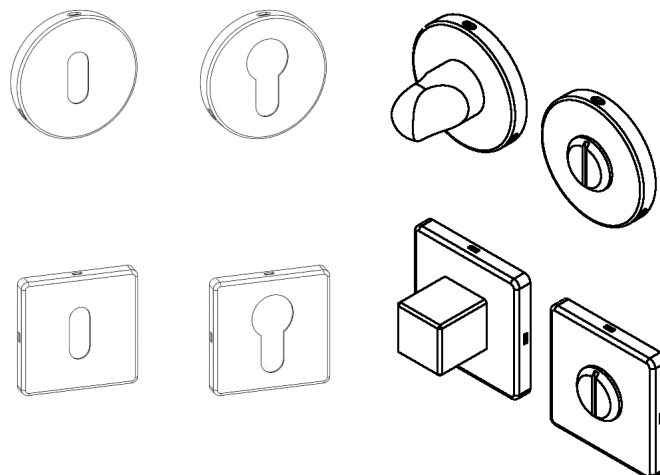

Redukce		10 mm	EAN	15 mm	EAN	18 mm	EAN	20 mm	EAN	30 mm	EAN
		cena / ks		cena / ks		cena / ks		cena / ks		cena / ks	
4/6 mm	Kč €	17,- 0,8	035070	20,- 0,9	035087						
5/6 mm	Kč €	17,- 0,8	035094	20,- 0,9	035100						
5/8 mm	Kč €									17,- 0,8	035117
6/7 mm	Kč €			17,- 0,8	50570						
6/8 mm	Kč €					20,- 0,9	28050			23,- 1,-	035124
8/8,5 mm	Kč €									23,- 1,-	50594
8/9 mm	Kč €							28,- 1,2	28579	28,- 1,2	035131
8/10 mm	Kč €									28,- 1,2	50587

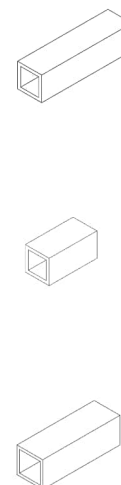

Komponenty k zámkům a pantům na sklo

Sřední díl pantu	cena ks	EAN
	Kč 60,- € 2,5	88221

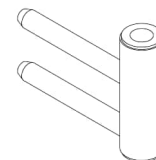

Podložka pro kliku	cena ks	EAN
černá	Kč 17,- € 0,8	88290
stříbrná	Kč 17,- € 0,8	88306



Vanička do zárubně krycí	cena ks	EAN
černá	Kč 27,- € 1,2	90897
stříbrná	Kč 27,- € 1,2	90903

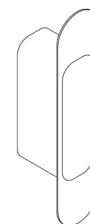

Vložka závěsu k pantům na sklo	cena ks	EAN
	Kč 81,- € 3,4	88238

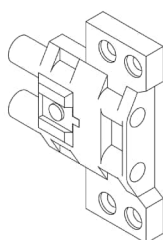

Sřední díl pantu do kovové zárubně	cena ks	EAN
	Kč 73,- € 3,1	90866

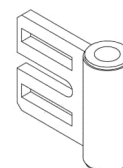

Spodní díl pantu	cena ks	EAN
	Kč 60,- € 2,5	90873

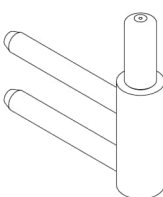

Spodní díl pantu do kovové zárubně	cena ks	EAN
	Kč 73,- € 3,1	90880

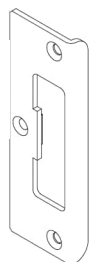
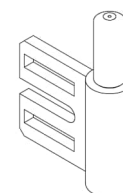

Protiplech do dřevěné zárubně	SNi cena / ks	EAN	SNi - br. cena / ks	EAN	Cr cena / ks	EAN	TiN-C cena / ks	EAN	TiN-K cena / ks	EAN	TiN-B cena / ks	EAN
	Kč 270,- € 12,-	88245	270,- 12,-	90859	340,- 15,-	88252	500,- 21,-	88276	540,- 23,-	88269	580,- 25,-	88283

M&T TITAN ochranný a čistící prostředek pro titanové a nerezové kování	cena ks	EAN
125 ml	Kč 270,- € 12,-	034912

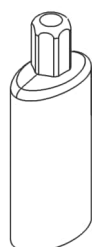

M&T SNI čistící prostředek pro kování s povrchem SNi matný nikl	cena ks	EAN
50 ml	Kč 110,- € 4,6	132809



**M&T**

Maximal

MINIMAL

Maximal kůže

## Prezentační panely a vzorkovnice produktů

Prezentační systém M&T je připraven pro přehlednou prezentaci produktů, kde je možnost volby umístění – tzn. buď do prostoru, nebo na stěnu s možností výběru vystavených vzorků, které jsou umístěny na plexi destičkách. Výhodou je flexibilita při výměně vzorků, kdy stačí pouze vyměnit plexi destičku bez jakékoli další montáže a demontáže. Samozřejmostí prezentací M&T je nadstandardní design prezentací, který odpovídá kvalitě vystavovaných produktů. K nejvyšším řadám kování jsou dále připraveny speciální vzorkové edice určené pro náročné zákazníky, kteří chtějí při vlastním výběru poznat možnosti povrchových úprav, barev a variant materiálů na produktech M&T.

Prezentační panel M&T oboustranný do prostoru



Prezentační panely M&T na stěnu



### konstrukční varianty, materiálové provedení

- vyměnitelné plexi destičky 140x235 mm, tl. 5 mm
- materiál plexi bílé lesklé opálové sklo pro zvýraznění produktu
- kování montováno se systémem vratných pružin jako na dveřích
- 9 pozic – destiček na jedné ploše prezentace
- panely na stěnu lze sestavovat vedle sebe v libovolném počtu
- panel do prostoru je oboustranný s 18 pozicemi plexi destiček
- materiál panelu přírodní dýha teak – olejováno
- rozměr panelu do prostoru - podstavec 300x400, výška panelu 1700 mm
- rozměr panelu na stěnu - šířka 380 mm, výška 1700 mm

Chráněné průmyslové vzory

design

prezentační panely M&T

se systémem vyměnitelných destiček

Využijte všech výhod a možností spolupráce a staňte se partnery M&T

Vzorkovnice Mimolimit s nabídkou dřevin rukojeti  
a povrchových úprav / barev rukojeti  
EAN 27091 ... 2670,- Kč / 112,- EUR



Kompletní vzorkovnice kování Minimal / Maximal  
s designy všech produktů a vzorkovnicí povrchových úprav / barev  
EAN 003451 ... 5320,- Kč / 222,- EUR



Kompletní vzorkovnice povrchů, 15 povrchových úprav / barev  
EAN 030761 ... 2600,- Kč / 109,- EUR



Panel Magnetic + madlo Konzerva 220 TiN-K  
 EAN 123098 ... 6900,- Kč / 288,- EUR



Panel Magnetic + madlo Yes! s otvorem 310 WC Cr-K  
 EAN 123104 ... 8160,- Kč / 340,- EUR

Panel plexi s dvojicí klik pro prezentaci na stůl s možností volby typu klik na panel  
 EAN 008012 ... 1940,- Kč / 81,- EUR



Neustálé inovace v M&T



Klika Minimal light svítící 20 let, bez baterií, bez el. zdroje



## SHOWROOMY, PRODEJNÍ SKLADY

### **M&T Praha**

U Třešňovky 1795/2

tel.: +420 286 840 726

+420 776 741 233

e-mail: [obchod@kliky-mt-praha.cz](mailto:obchod@kliky-mt-praha.cz)

[www.kliky-mt-praha.cz](http://www.kliky-mt-praha.cz)

### **M&T Plzeň**

Guldenerova 23

tel.: +420 377 243 423

+420 602 414 149

e-mail: [objednavky@kliky-mt-plzen.cz](mailto:objednavky@kliky-mt-plzen.cz)

[www.kliky-mt-plzen.cz](http://www.kliky-mt-plzen.cz)

### **M&T Brno**

Bratislavská 22

tel.: +420 545 211 213

e-mail: [info@kliky-mt-brno.cz](mailto:info@kliky-mt-brno.cz)

[www.kliky-mt-brno.cz](http://www.kliky-mt-brno.cz)

### **M&T Dobruška**

Čs. odboje 1044

tel.: +420 491 474 632

+420 774 700 258

e-mail: [info@kliky-mt.cz](mailto:info@kliky-mt.cz)

[www.kliky-mt.cz](http://www.kliky-mt.cz)

### **M&T Bratislava**

Komplex NIDO-2

křižovatka ulic Trnavská cesta + Tomášikova

tel.: +421 948 939 998

+421 948 682 182

e-mail: [info@klucky-mt.sk](mailto:info@klucky-mt.sk)

[www.klucky-mt.sk](http://www.klucky-mt.sk)

Tento katalog / ceník je pouze informativní s možností změn a úprav během kalendářního roku. Tiskové chyby jsou vyhrazeny. Veškerá foto jsou pouze ilustrativní, přesné materiálové a barevné provedení výrobků si prohlédněte u svého prodejce kování M&T. Katalog / ceník neobsahuje kompletní údaje o rozměrech, konstrukčním provedení, použití, systémech montáže. Kompletní údaje o výrobcích M&T jsou uvedeny na [www.kliky-mt.cz](http://www.kliky-mt.cz).

Veškeré uváděné ceny v celém katalogu / ceníku jsou bez DPH.





Kování z masivní mosazi  
a nerezové oceli  
s trvalou hodnotou

**M&T**  
manufacture 1997

**M&T 1997, a.s.**

centrála

Čs. odboje 1044

518 01 Dobruška

tel.: +420 491 474 632

+420 774 700 258

e-mail: [info@kliky-mt.cz](mailto:info@kliky-mt.cz)

[www.kliky-mt.cz](http://www.kliky-mt.cz)

**M&T Slovensko s.r.o.**

Komplex NIDO-2

křižovatka ulic Trnavská cesta + Tomášikova

821 03 Bratislava

tel.: +421 948 939 998

+421 948 682 182

e-mail: [info@klucky-mt.sk](mailto:info@klucky-mt.sk)

[www.klucky-mt.sk](http://www.klucky-mt.sk)

